

JUMO ecoTRANS pH 03

Microprocessor/transmitter / switching device
for pH value / redox voltage and temperature



B 20.2723.0
Operating manual



1	Typographical conventions	6
1.1	Warning signs	6
1.2	Note signs	6
2	Notes	7
3	Identifying the instrument version	8
3.1	Type description	8
4	Mounting	9
5	Electrical connection	9
5.1	Connecting the sensor	10
5.2	Customizing the special coaxial line	11
6	Commissioning	15
6.1	Brief description of the instrument	15
6.2	Block diagram	16
6.3	Applying the supply voltage	16
7	Adjusting / changing instrument functions	17
7.1	Process value display	17
7.2	Operation	18
7.3	Key function	18
7.4	Selecting levels	20
7.5	User level (USER)	21
7.6	Administrator level (ADMIN)	22
7.7	Enable level (RIGHT)	23
7.8	Calibration level (CALIB)	24
8	Configurable parameters	25
8.1	Inputs	26
8.1.1	Measurement input - main value (submenu "PH")	26
8.1.2	Measurement input - temperature (submenu "TEMP")	28
8.1.3	Binary input	29
8.2	Relays	30
8.2.1	Binary output 1 (submenu "BIN.1")	30
8.3	Analog outputs	33
8.3.1	Main value (submenu "PH.OUT")	33
8.3.2	Temperature (submenu "TE.OUT")	36
8.3.3	Calibration settings	39

9	Calibration	40
9.1	General information	40
9.1.1	When is calibration required?	40
9.2	Activating and starting calibration mode	40
9.2.1	Starting calibration from the calibration level "CALIB"	41
9.2.2	Starting calibration with the hot key (rapid access)	41
9.3	Canceling calibration and error messages	42
9.3.1	Zero point error	42
9.3.2	Slope error	42
9.3.3	General error during calibration	42
9.3.4	Acknowledging errors	43
9.3.5	Additional measures	43
9.4	One-point or two-point calibration	43
9.4.1	Selecting one-point calibration	43
9.4.2	Selecting two-point calibration	44
9.5	Calibrating a pH measurement chain	44
9.5.1	One-point calibration (zero point)	44
9.5.2	Two-point calibration (zero point and slope)	45
9.6	pH antimony measurement chain	48
9.7	Redox measurement chain	48
9.7.1	General information	48
9.7.2	One-point calibration (recommended calibration)	48
9.7.3	Two-point calibration	50
10	Analog output	52
10.1	Behavior of the output signal during calibration	52
10.2	Behavior of the output signal in case of error	52
10.3	Output signal in case of error	53
10.4	Output signal when leaving the scaling range	53
10.5	Manual mode of the analog output	53
11	Relay output	54
11.1	Relay behavior	54
11.2	Binary output 1 (submenu "BIN.1")	54
11.3	Manual mode of the relay output	57
11.4	Behavior of the relay during calibration	58
11.5	Pulse function of the relay output	58
11.6	Behavior of the relay in case of error	60
11.7	Error detection	60

12	Display and LED messages	62
12.1	Operating states of JUMO ecoTrans pH 03	62
12.2	Underrange	62
12.3	Overrange	62
12.4	Broken sensor	62
12.5	Short-circuit	63
12.6	Initialization of dependent parameters	63
12.7	Calibration timer elapsed	63
13	Operation via setup interface	64
13.1	Operation with PC setup program	65
14	Technical data	66
15	Environment/disposal	69

1 Typographical conventions

1.1 Warning signs



Danger

This symbol is used when there may be **danger to personnel** if the instructions are ignored or not followed correctly!



Caution

This symbol is used when there may be **damage to equipment or data** if the instructions are ignored or not followed correctly!



Caution

This symbol is used where special care is required when handling components liable to damage through electrostatic discharge.

1.2 Note signs



Note

This symbol is used to draw your **special attention** to a remark.

abc¹

Footnote

Footnotes are remarks that **refer to specific points** in the text. Footnotes consist of two parts:

Marking in the text and the footnote text.

The markers in the text are arranged as continuous superscript numbers.

*

Action instruction

This symbol indicates that an **action to be performed** is described.

The individual steps are marked by this asterisk.

Example:

* Loosen Phillips-head screws.

2 Notes



To protect the device from static electrical discharge, the user must be electrostatically discharged before touching the instrument!

All necessary settings are described in these operating instructions. If any difficulties should nevertheless arise during startup, please do not tamper with the instrument in any way. By doing so, you could endanger your rights under the instrument warranty! Please contact the nearest subsidiary or the head office in such a case.

Please read these operating instructions before placing the instrument in service. Keep the manual in a place which is accessible to all users at all times. Please assist us in improving these operating instructions where necessary.

For technical questions

Service hotline:

Phone: 0661 6003-300 or
0661 6003-653

Fax: 0661 6003-881300 or
0661 6003-881653

E-mail: Service@jumo.net

3 Identifying the instrument version

The nameplate with the order code glued onto the side of the instrument. The connected supply voltage must match the voltage specified on the nameplate.

3.1 Type description

(1) Basic type

202723 JUMO ecoTRANS pH 03,
Microprocessor/transmitter / switching device for
pH value / redox voltage and temperature

(2) Output I (pH value / redox voltage)

888 Analog actual value output, freely programmable

(3) Output II (temperature)

000 None

888 Analog actual value output, freely programmable

(4) Output III (switching)

000 None

101 1 x relay, switching contact

(5) Extra codes

000 None

024 With PC setup software

	(1)	(2)	(3)	(4)	(5)
Order code	<input type="text"/>	<input type="text"/>	<input type="text"/>	<input type="text"/>	<input type="text"/>
Order example	202723	/ 888	- 888	- 101	/ 000

4 Mounting

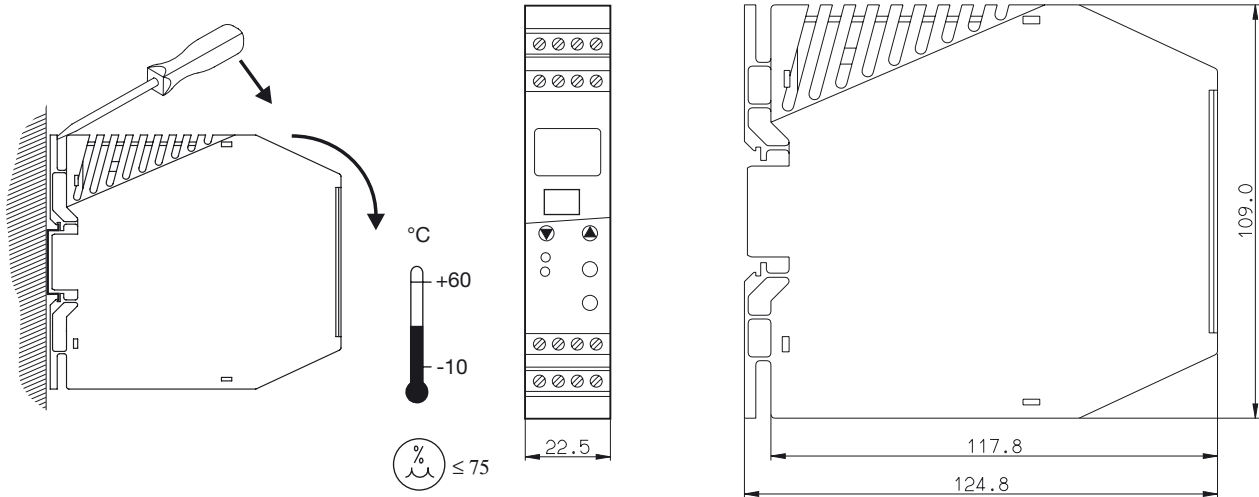

5 Electrical connection

The choice of cable, the installation, and the electrical connection must conform to the requirements of VDE 0100 “Regulations on the Installation of High-Voltage Systems with Nominal Voltages below 1000 V” or the appropriate local regulations.

- To protect the device from static electrical discharge, the user must be electrostatically discharged before touching the instrument!
- The electrical connection must only be carried out by qualified personnel.
- Electromagnetic compatibility conforms to the standards and regulations cited in the technical data.
- Operates only on SELV or PELV circuits.
- The instrument is **not** suitable for installation in areas with an explosion hazard.

Apart from faulty installation, incorrect settings on the instrument may also affect the proper functioning of the subsequent process or lead to damage. Safety devices should always be provided that are independent of the instrument (such as overpressure valves or

temperature monitors/limiters) and only capable of adjustment by specialist personnel. Please observe the relevant safety regulations for such matters.

- ❑ The load circuit must be fused for the maximum relay current, in order to prevent the output relay contacts from becoming welded in the event of a short circuit.
- ❑ The supply voltage must be fed into the instrument through a 125-mA fuse, medium time lag or comparable protection by means of a separate branch.
- ❑ Do not connect any additional loads to the screw terminals for the supply of the instrument.
- ❑ Any electrical connection deviating from the connection diagram may cause the instrument to be destroyed.
- ❑ Lay the input, output, and supply lines so they are physically separated from each other and are not parallel.
- ❑ Lay probe cables only as continuous lines, twisted and shielded (**not** via series terminals or similar arrangements).
- ❑ Fluctuations in supply voltages are only permitted within specified tolerances (see datasheet 20.2723).
- ❑ The instrument must not be mounted or dismounted unless it is in dead state and/or the lines are not connected.

5.1 Connecting the sensor

To connect the pH redox electrode, special coaxial line type 2990, type 2992 or type 2994 is recommended as specified by JUMO datasheet 20.1090, pages 1 to 3. Standard commercial antenna or computer lines with coaxial construction are generally not suitable. They may result in faulty readings or could destroy the pH or redox electrode.

The semiconducting layer (see Fig. (2)) of the special coaxial line must be at a sufficient distance to prevent a short circuit with the inner conductor on the transmitter terminal. The coaxial line may be sensitive to touch or motion due to the high internal resistance of a

pH electrode. This must be taken into consideration when laying the cable.

5.2 Customizing the special coaxial line

Example:

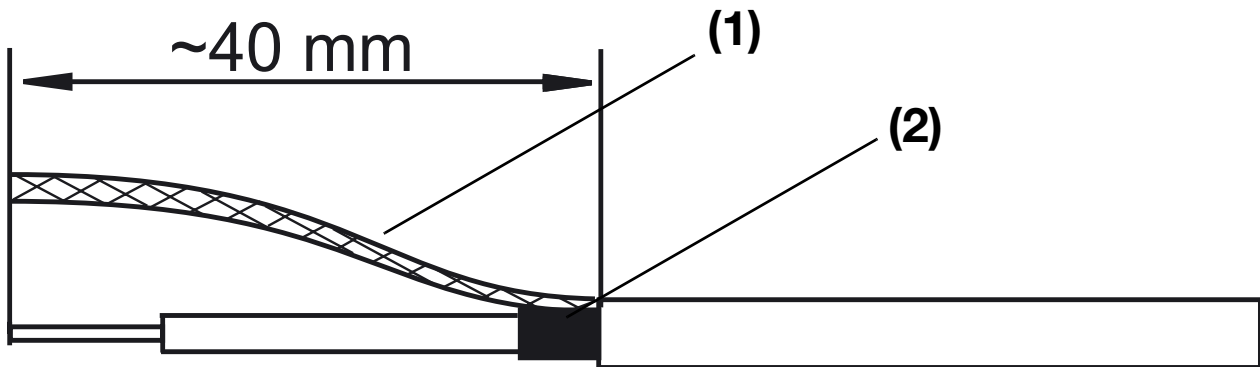

- * Strip insulation from the line as shown in the drawing. Remove the black semiconducting layer (2) from the insulation of the inner conductor as indicated.
- * Twist the shield (1) and insulate with a shrink tubing.

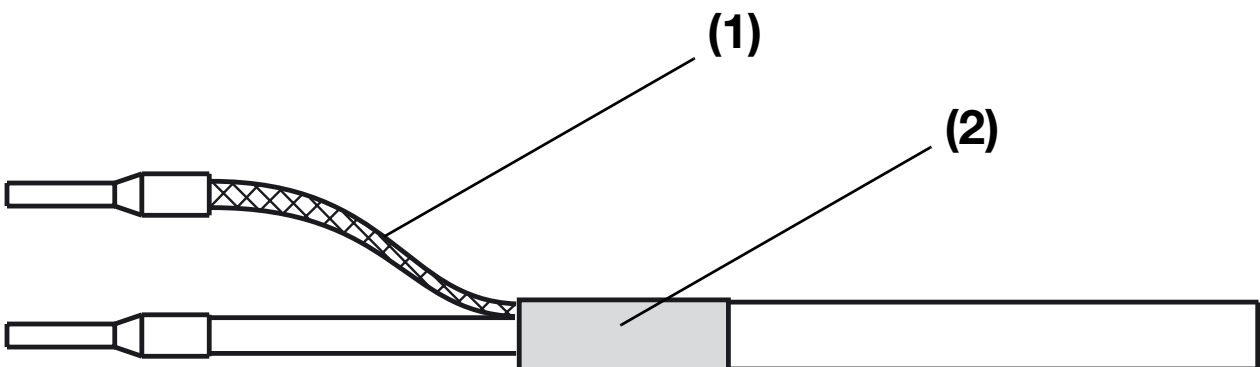

- * Insulate the black semiconducting layer with shrink tubing (2) to prevent short circuits.
- * Place ferrules on the line ends.

Terminal assignment

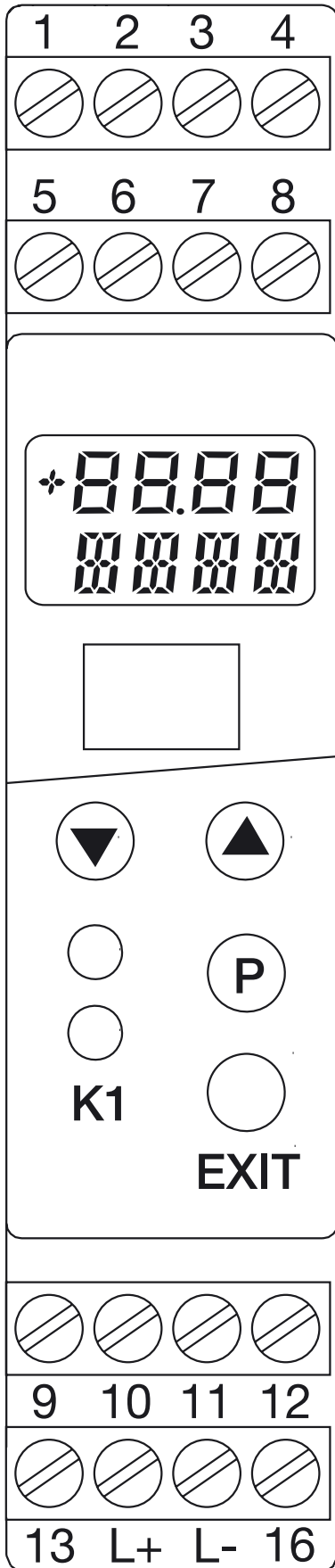

Measurement inputs	Terminal assignment		Symbol
pH electrode or Redox combination electrode	16 13	Reference system (braiding) Glass electrode/metal electrode (inner conductor)	
pH glass electrode or Metal electrode (with isolated reference electrode)	13	Glass electrode/metal electrode (inner conductor)	
Reference electrode (with isolated electrodes)	16	Reference system	
Liquid potential (connect only with symmetrical connection)	12		
Resistance thermometer in 2-wire circuit	9 10		

Binary input	11 12		
--------------	----------	--	---

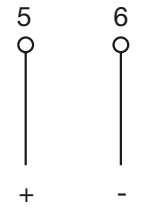
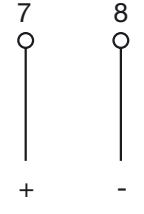
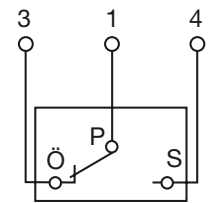
Outputs	Terminal assignment		Symbol
I Analog process value output pH/redox (galvanically isolated)	5 6	+ -	
II Analog process value output - temperature (galvanically isolated)	7 8	+ -	
III Relay	1 3 4	Pin Break (SPST-NC) Make (SPST-NO)	

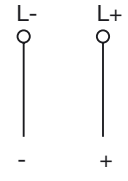
Power supply	Terminal assignment		Symbol
Power supply (with reverse polarity protection)	L- L+		

6 Commissioning

6.1 Brief description of the instrument

The instrument measures and, depending on the configuration, regulates the pH or redox voltage in aqueous solutions. The range of applications includes general water and wastewater management, measuring drinking and wastewater, process water, surface and ocean water, swimming pool and fountain water, and professional aquariums, etc.

The transmitter has two analog inputs. The first analog input (main input for pH value or redox voltage) is provided for connecting electrodes with an isolated reference electrode. The instrument is also prepared for connecting antimony electrodes. A resistance thermometer (Pt 100 or Pt 1000) can be connected to the second analog input.

Up to two analog outputs and one relay switching contact are available. The analog outputs are galvanically isolated and assigned to the inputs. Either the main value (pH or redox voltage) or the temperature can be assigned to the relay contact.

The keys and integrated LD display are used to operate and configure the instrument. This can also be done very conveniently with the setup connection (Notebook / PC) using the optional setup program. The setup program can also be used to print configuration data. This makes system documentation easier.

Instruments are delivered with a calibration verification tool that is used to document instrument and calibration data.

6.2 Block diagram

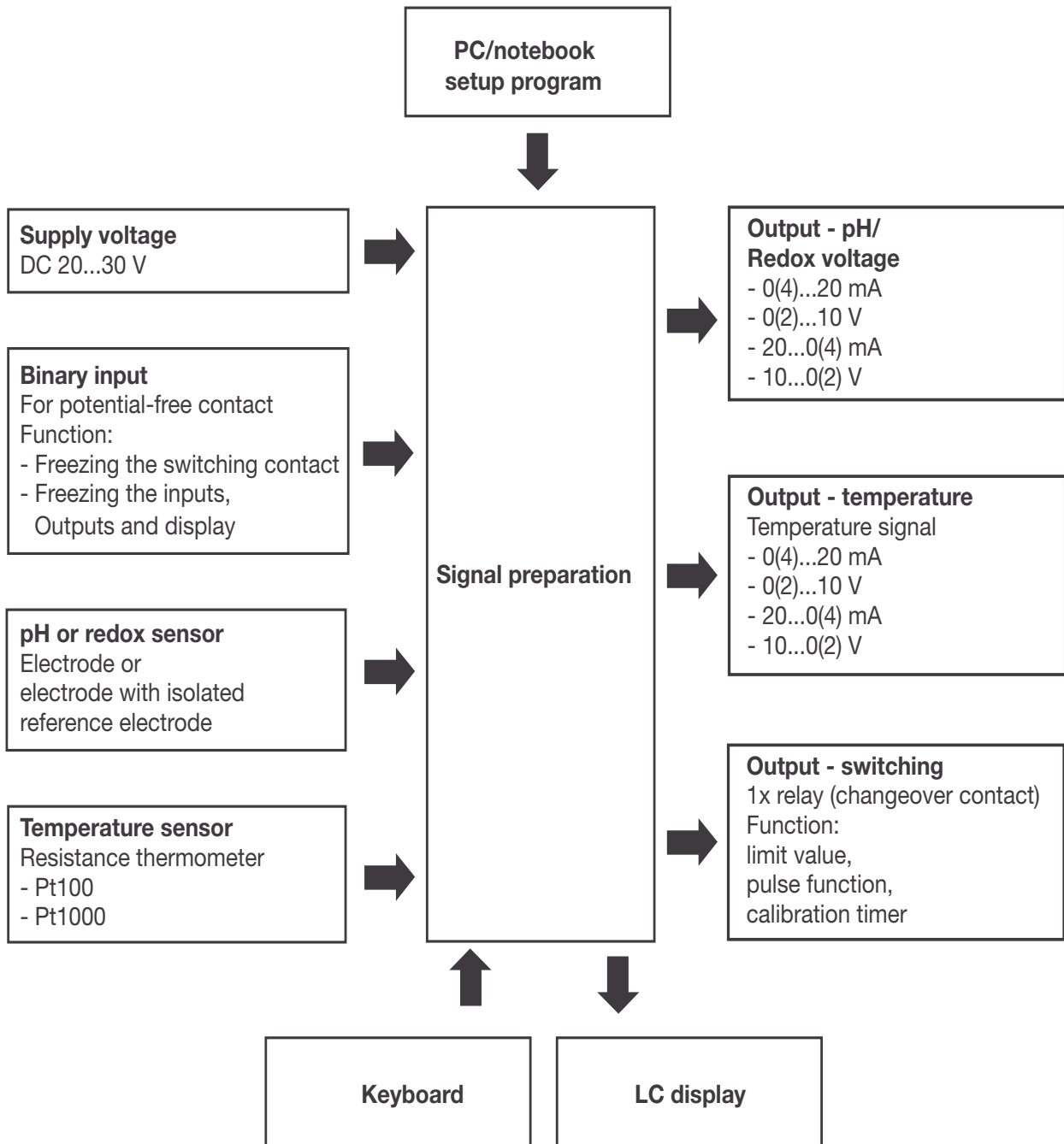

6.3 Applying the supply voltage

If the instrument has been correctly connected, all LCD segments are briefly lit immediately after the supply voltage is applied.

Note:

After the instrument is started, the output signal is 0 V or 0 mA. The relay is in idle state (inactive). After about 2 seconds, the JUMO ecoTRANS pH 03 begins working according to the configuration.

7 Adjusting / changing instrument functions

Changes can be made in the setup program or with the JUMO ecoTRANS pH 03 keys.

7.1 Process value display

The process value display can be either

- in static mode or in
- alternating mode

Static display (default setting)



Compensated pH value



redox voltage

Alternating display (at a fixed rate of about 3 seconds)



Compensated pH value

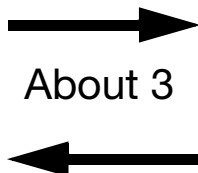

Current temperature
with current unit

Change from static display to alternating display

- * Press the (P) key (for less than 2 sec)

Change from alternating display to static display

- * Press the (P) key (for less than 2 sec)

7.2 Operation

The instrument can be operated on different levels.

Access to all levels (except the user level) is protected by different codes².

On the **User level** (USER) all parameters can be viewed and/or modified depending on user rights¹ (see Enable level).

On the **Calibration level** (CALIB) the electrode zero point (intercept point) and/or the electrode slope can be calibrated.

On the **Enable level** (RIGHT) user rights can be defined.

On the **Administrator level** (ADMIN) all parameters can be set (configured).

The different codes and settings on the Enable level make it possible to assign different user rights to users.

¹ The factory setting for all parameters is "READ," i.e. all parameters can only be read on the User level, not changed.

² Codes for the Administrator and Enable levels can only be changed with the setup program (see Section 13 "Operation via setup interface", page 64).

7.3 Key function



After 60 seconds with no user activity (no keystrokes), the display reverts to process value display.

This timeout function is not active during calibration!

- The UP and DOWN keys are used to select a submenu in the main menu and to scroll forward and backward.
- The P key switches to the corresponding submenu.
- To change (edit) a parameter, press the P key.
- When the parameter is released for editing, the value flashes. If the parameter is locked, "LOCK" appears in the display.
- To change the parameter, it must be unlocked on the Enable level (changed from "rEAd" to "Edit").

-
- To increase or reduce the value, press the UP or DOWN key.
 - The value can then be accepted with the P key.
 - The EXIT key is used to cancel the entry and switch to the next higher level.

7.4 Selecting levels

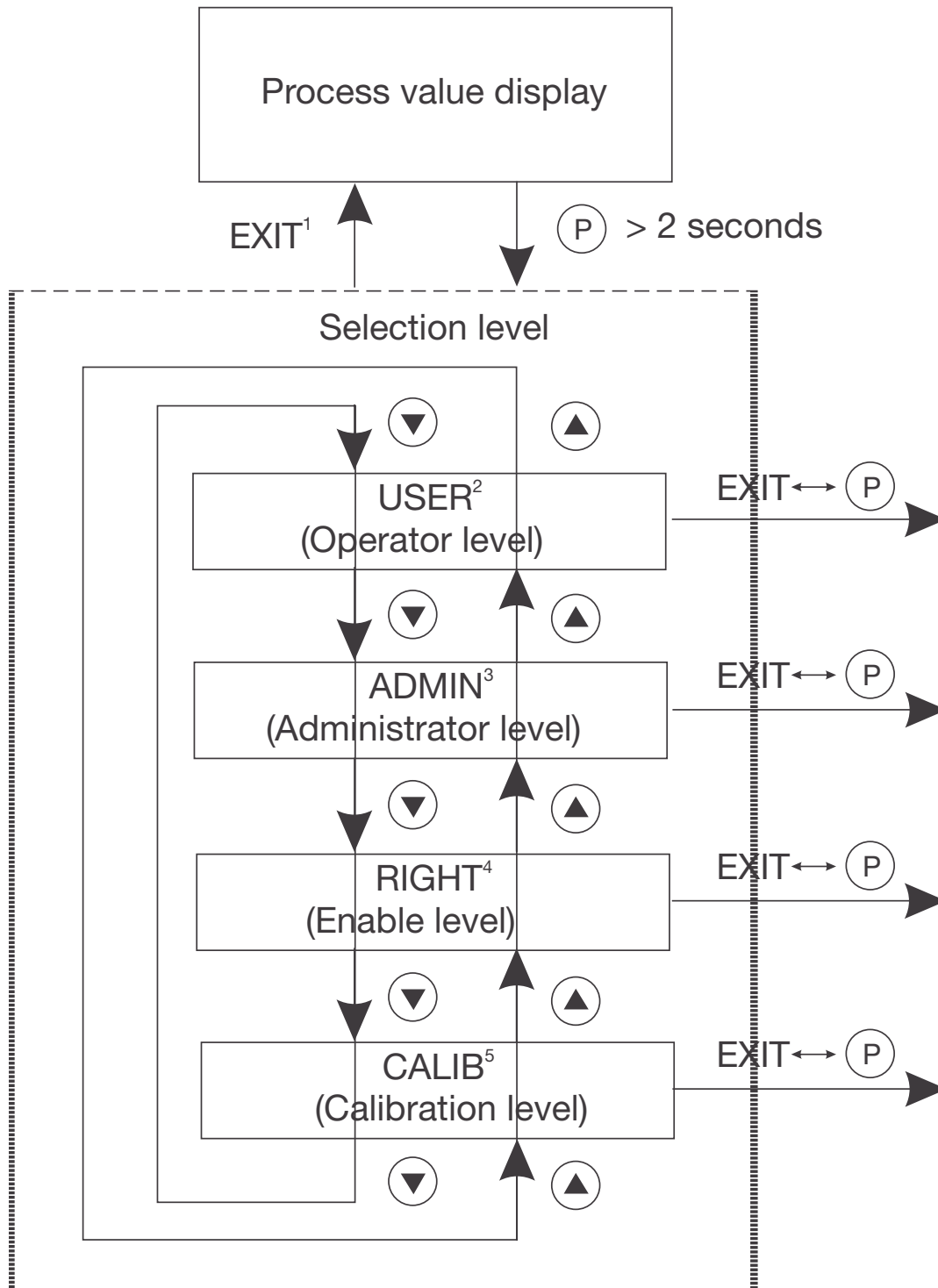

¹ Timeout (automatically jumps back after 60 sec. with no activity).

² See Section 7.5 "User level (USER)", page 21.

³ See Section 7.6 "Administrator level (ADMIN)", page 22.

⁴ See Section 7.7 "Enable level (RIGHT)", page 23.

⁵ See Section 7.8 "Calibration level (CALIB)", page 24.

7.5 User level (USER)

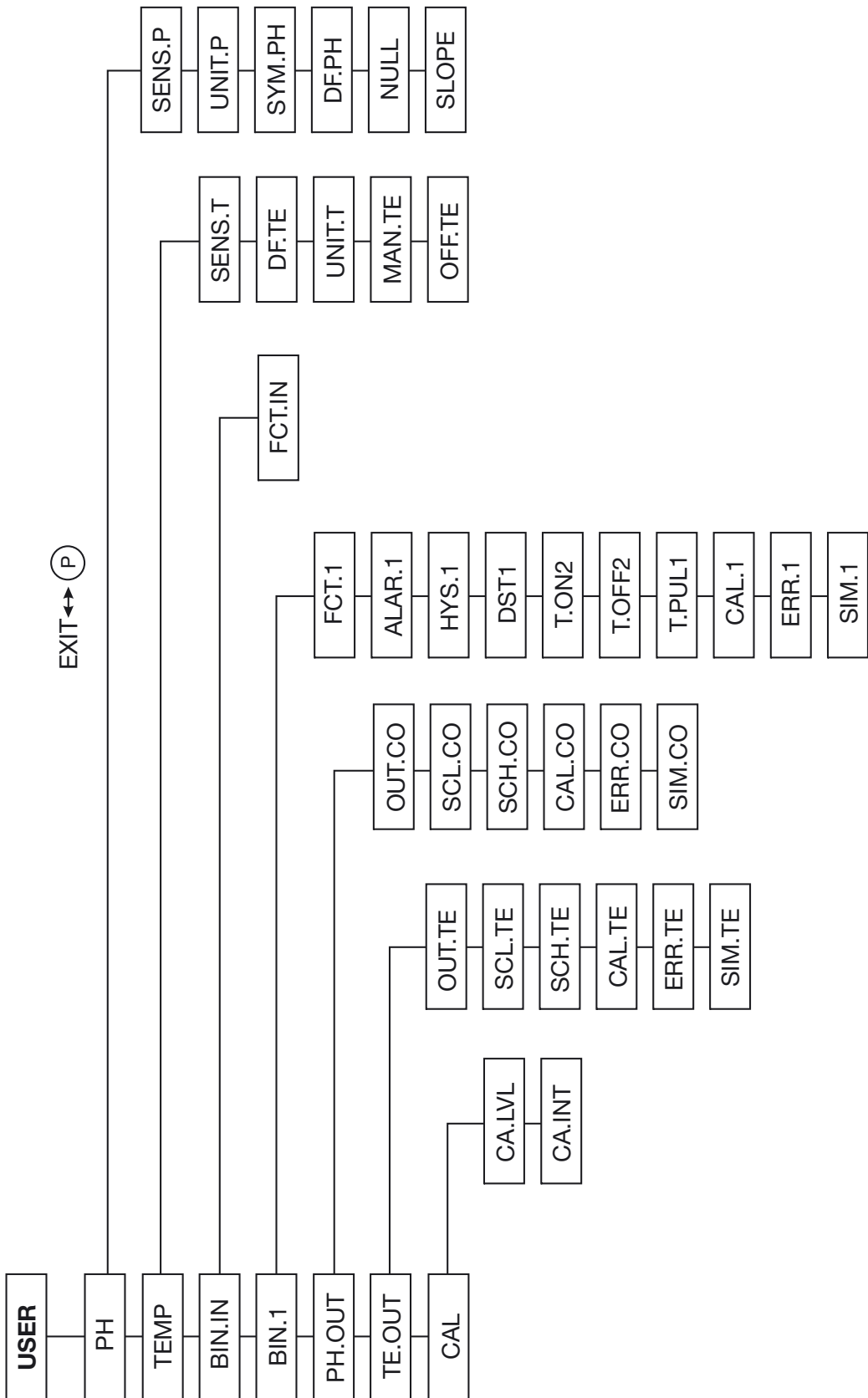

7.6 Administrator level (ADMIN)

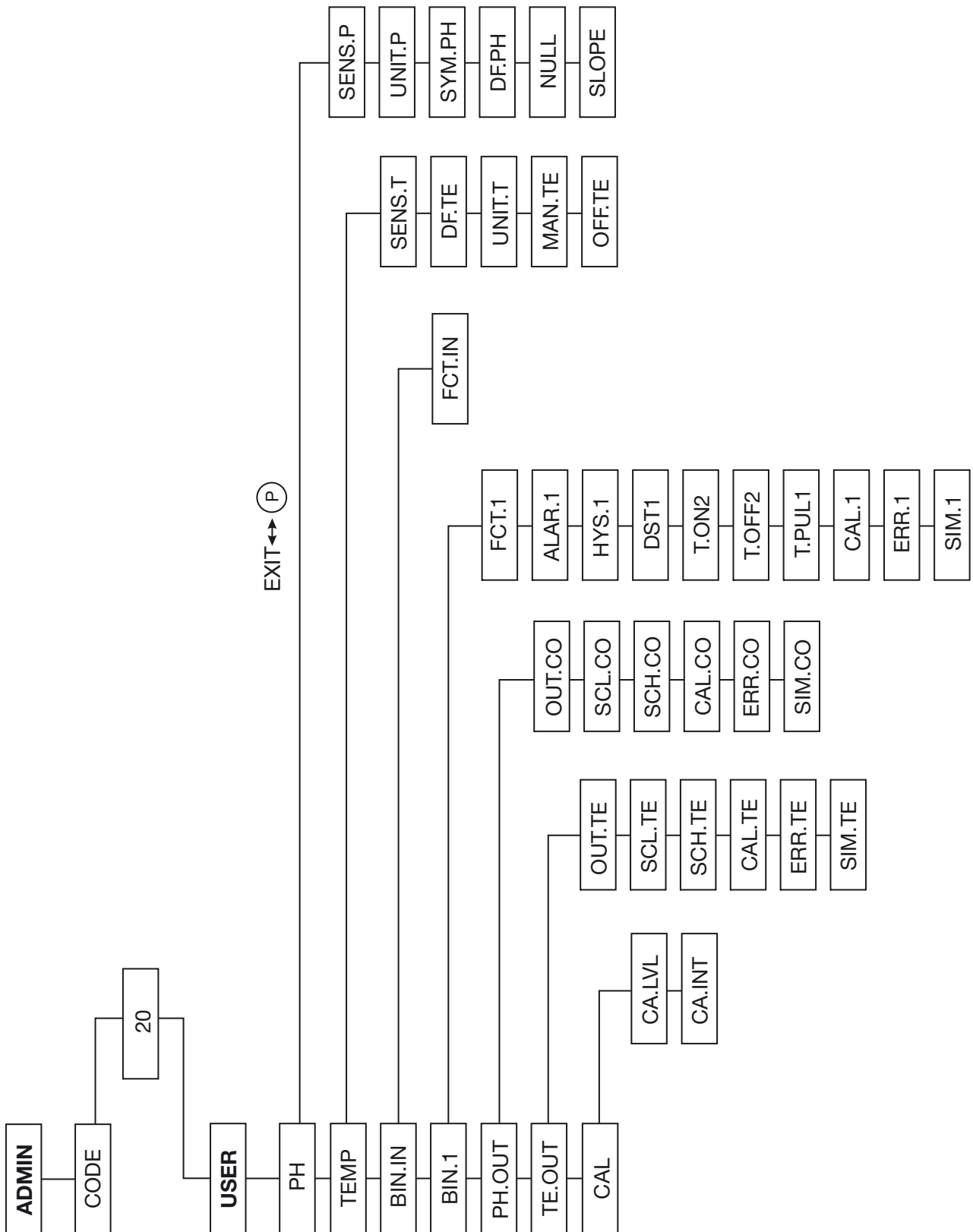

7.7 Enable level (RIGHT)

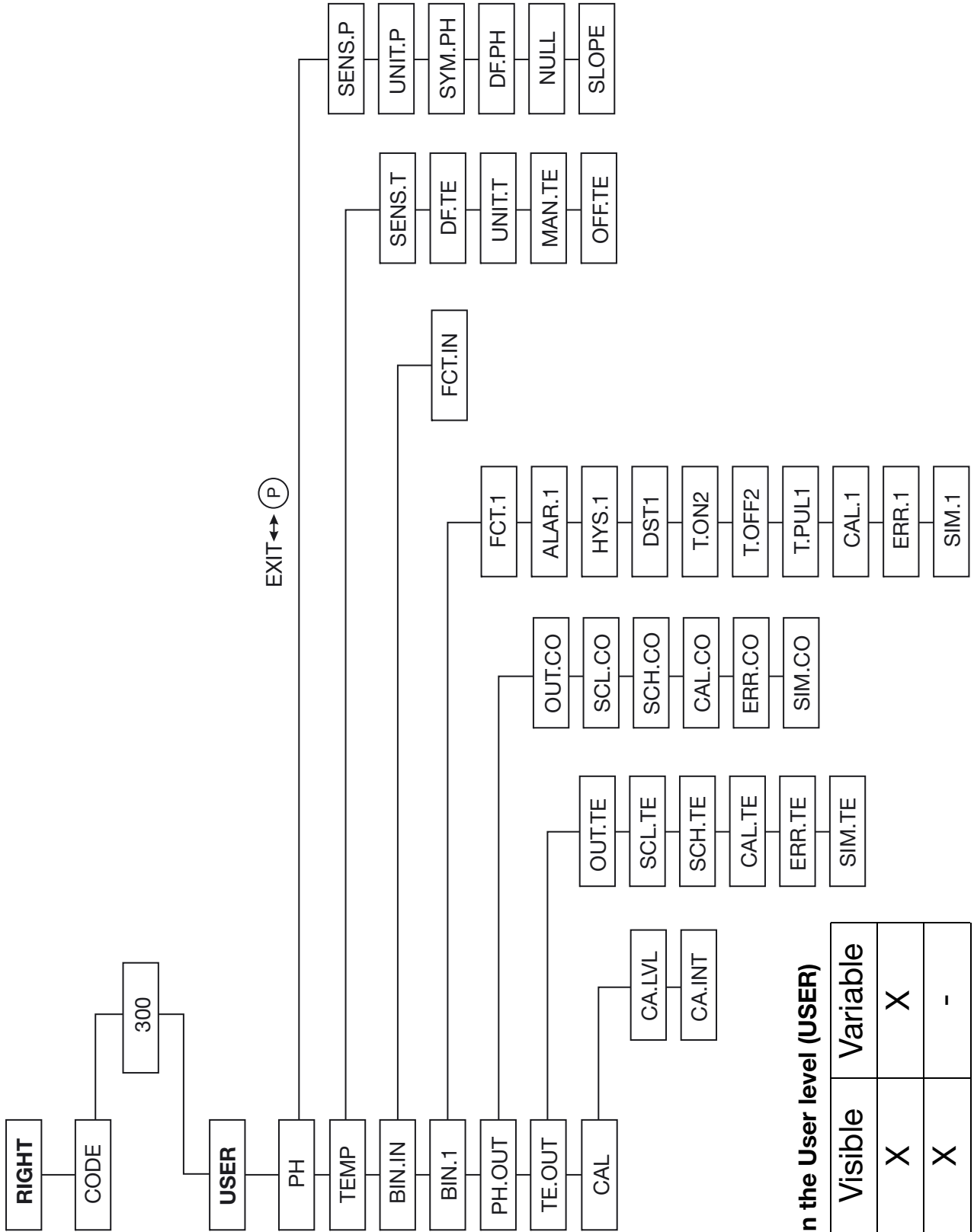

Parameters on the User level (USER)

Value	Visible	Variable
EDIT	X	X
READ	X	-

7.8 Calibration level (CALIB)

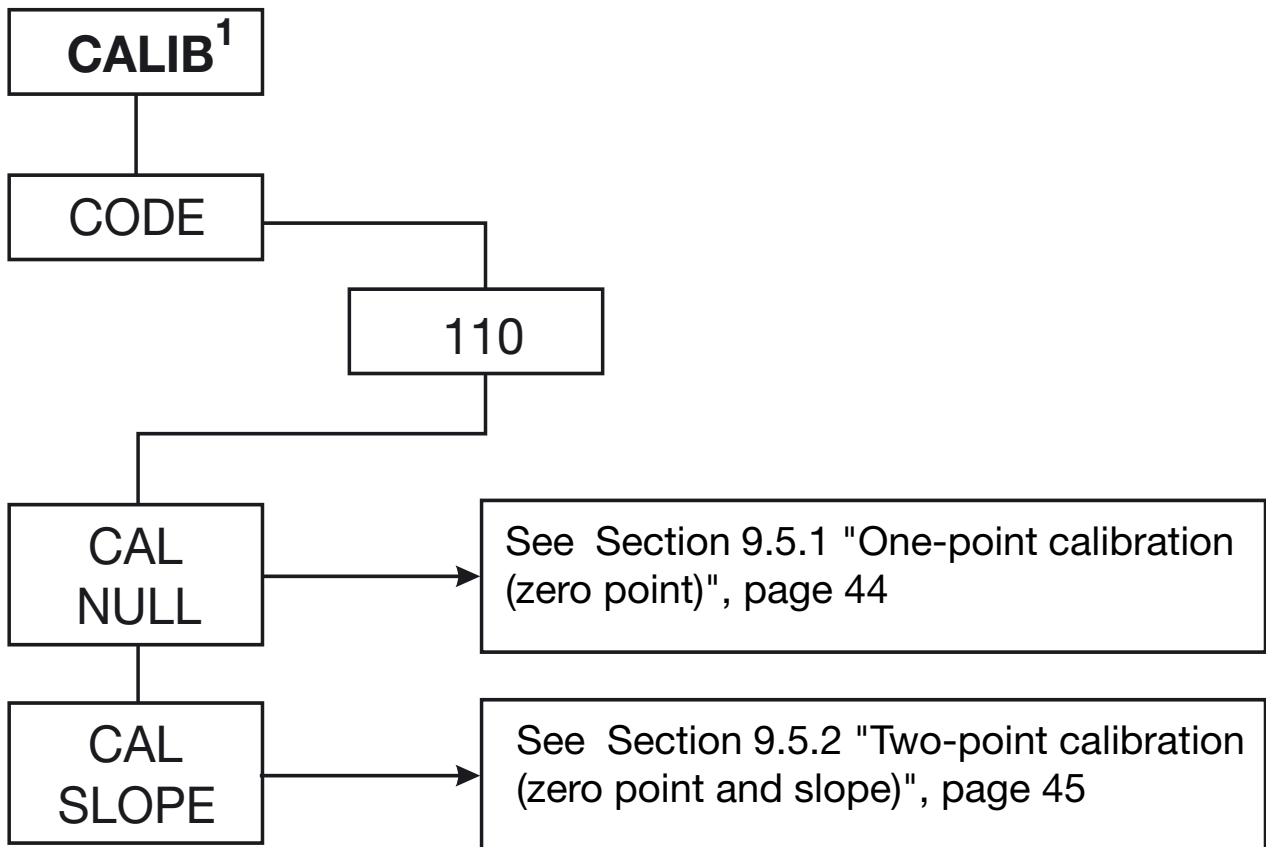

The timeout function is **not** active during calibration!

¹ See Section 9 "Calibration", page 40.

8 Configurable parameters



Parameters can be set with the setup program or on the instrument.

Since some parameters are independent of each other, it may be necessary when one parameter is changed to adjust others as well.

Example:

When the measurement variable is changed (from pH to redox voltage or vice versa) the display format, setpoints, and other parameters are adjusted.

While parameters are being adjusted internally, the display appears as follows:

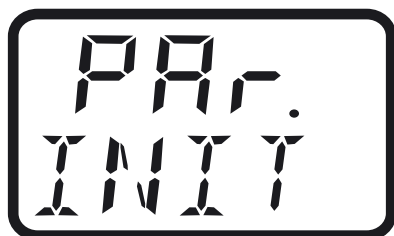

8.1 Inputs

8.1.1 Measurement input - main value (submenu "PH")

Parameter	Display	Setting range ¹
Measurement variable	SENS.P	0 = pH (default) 1 = pH antimony 2 = redox
Unit of measure (only for "redox" measurement variable)	UNIT.P	0 = mV 1 = %
Activation of symmetrical pH value recording. Caution: Before activation, terminal 12 must be connected with the liquid potential!	SYM.PH	0 = Off (default mode is asymmetrical) 1 = On

¹ The default setting is marked in **bold**.

Parameter	Display	Setting range ¹
Filter constant main value (2nd order filter)	DF.PH	0... 1 ...99 seconds
Electrode zero point	ZERO	5.00... 7.00 ...9.00 pH (pH default) -2.00... 0.00 ...2.00 pH (pH antimony) -999... 0 ...999 mV (redox)
Electrode slope	SLOPE	75.0... 100.0 ...110.0% (pH default) 10.0...100.0...110.0% (pH antimony) -999.9...100.0...999.9% (redox)

¹ The default setting is marked in **bold**.

8.1.2 Measurement input - temperature (submenu "TEMP")

Parameter	Display	Setting range ¹
Probe type	SENS.T	0 = Manual temperature entry 1 = Pt100 2 = Pt1000
Filter constant temperature (2nd order filter)	DF.TEM	0... 1 ...99 seconds
Temperature unit	UNIT.T	0 = °C 1 = °F
Manual temperature entry	MAN.TE	-10... 25 ...150.0°C or 14... 77 ...302°F Note: The default setting depends on which temperature unit "UNIT.T" is selected.

¹ The default setting is marked in **bold**.

Parameter	Display	Setting range ¹
Process value correction Temperature (offset)	OFF.TE	-20.00... 0 ...20.00°C or -36... 0 ...36°F Note: The default setting depends on which temperature unit "UNIT.T" is selected.

8.1.3 Binary input

Parameter	Display	Setting range ¹
Activation by potential-free contact	FCT.IN	0 = No function 1 = Freeze switching output 2 = Freeze analog outputs 3 = Freeze all outputs 4 = Freeze process value recording

¹ The default setting is marked in **bold**.

8.2 Relays

8.2.1 Binary output 1 (submenu "BIN.1")

Parameter	Display	Setting range ¹
Switching function Note: Changes to this parameter affect: - ALAR.1 - HYS.1.	FCT.1	0 = No function 1 = Window contact main value (active inside a window) ² 2 = Window contact main value (active outside a window) ² 3 = Max contact main value (normally open (NO), similar to LK7) ² 4 = Min contact main value (normally closed (NC), similar to LK8) ² 5 = Window contact temperature (active inside a window) ² 6 = Window contact temperature (active outside a window) ² 7 = Max contact temperature (normally open (NO), similar to LK7) ² 8 = Min contact temperature (normally closed (NC), similar to LK8) ² 9 = Error output 10 = Calibration timer elapsed

¹ The default setting is marked in **bold**.

² see Section 11 "Relay output", page 54

Parameter	Display	Setting range ¹
Switching point	ALAR.1²	<p>pH: -2.00 ... 0 ... 16.00 pH</p> <p>Redox: -1500 ... 0 ... 1500 mV</p> <p>Temperature: -10.0 ... 0 ... +150°C +14.0 ... 0 ... +302°C</p>
Hysteresis	HYS.1.	<p>0.00 ... 1.00 ... 9.00 pH</p> <p>0 ... 1 ... 1500 mV</p> <p>0 ... 1 ... 50%</p> <p>0 ... 1 ... 80°C</p> <p>0 ... 1 ... 144°F</p>
Half window width	DST.1	<p>0.00 ... 1.00 ... 9.00 pH</p> <p>0 ... 1 ... 1500 mV</p> <p>0 ... 1 ... 50%</p> <p>0 ... 1 ... 80°C</p> <p>0 ... 1 ... 144°F</p>
Energizing delay	T.ON1	0... 2 ...0.999 seconds

¹ The default setting is marked in **bold**.

² The setting range depends on the switching function FCT.1 selected

Parameter	Display	Setting range ¹
De-energizing delay	T.OFF1	0...1..0.999 seconds Note: This parameter is only active if the pulse time is "T.PUL1" 0.
Pulse time	T.PUL1	0...999 seconds, see Section 11 "Relay output", page 54
Behavior of binary output 1 in calibration mode	CAL.1	0 = inactive 1 = active 2 = remains in current state
Response in case of error	ERR.1	0 = inactive 1 = active 2 = frozen (relay remains unchanged)
Manual mode	SIM.1	0 = inactive 1 = active 2 = no manual mode

¹ The default setting is marked in **bold**.

8.3 Analog outputs

8.3.1 Main value (submenu "PH.OUT")

Parameter	Display	Setting range ¹
Type of unit signal	OUT.PH	0 = 0...20 mA 1 = 4...20 mA 2 = 20...0 mA 3 = 20...4 mA 4 = 0...10 V 5 = 2...10 V 6 = 10...0 V 7 = 10...2 V Note: If there is a change in the type of unit signal "OUT.PH", manual mode of the output is deactivated.

¹ The default setting is marked in **bold**.

Parameter	Display	Setting range ¹
Initial value of scaling	SCL.PH	<p>-2.00 ... 14.20 pH (pH) -15.00 ... 1200 mV (Redox) 0 ... 90% (Redox voltage)</p> <p>Note: The interval between the initial value of scaling "SCL.PH" and the final value of scaling "SCH.PH" must be at least 10% of the measurement range.</p>
Final value of scaling	SCH.PH	<p>-0.20 ... 16.00 pH (pH) -1200 ... 1500 mV (redox voltage) 10 ... 100% (redox voltage)</p> <p>Note: The interval between the initial value of scaling "SCL.PH" and the final value of scaling "SCH.PH" must be at least 10% of the measurement range.</p>
Behavior in calibration mode	CAL.PH	<p>0 = Concurrent 1 = Current status is maintained</p>

¹ The default setting is marked in **bold**.

Parameter	Display	Setting range ¹
Response in case of error	ERR.PH	0 = LOW (e.g. 0 V) 1 = HIGH (e.g. 10 V) 2 = LOW NAMUR (1.4 V / 3.4 mA) 3 = HIGH NAMUR (10.7 V / 22 mA)
Manual mode of the analog output - conductivity	SIM.pH	OFF = no manual mode 0...22 mA or 0...10.7 V

¹ The default setting is marked in **bold**.

8.3.2 Temperature (submenu "TE.OUT")

Parameter	Display	Setting range ¹
Type of unit signal	OUT.TE	0 = 0...20 mA 1 = 4...20 mA 2 = 20...0 mA 3 = 20...4 mA 4 = 0...10 V 5 = 2...10 V 6 = 10...0 V 7 = 10...2 V Note: If there is a change in the type of unit signal "OUT.TE", manual mode of the output is deactivated.

¹ The default setting is marked in **bold**.

Parameter	Display	Setting range ¹
Initial value of scaling	SCL.TE	<p>-10.0 ... +134.0°C or 50.0 ... 273.0°F</p> <p>Note: The setting range and default setting depend on the temperature unit "UNIT.T" that is selected. The interval between the initial value of scaling "SCL.TE" and the final value of scaling "SCH.TE" must be at least 10% of the measurement range.</p>
Final value of scaling	SCH.TE	<p>6.0 to 150.0°C or 42.8 ... 302.0°F</p> <p>Note: The setting range and default setting depend on the temperature unit "UNIT.T" that is selected. The interval between the initial value of scaling "SCL.TE" and the final value of scaling "SCH.TE" must be at least 10% of the measurement range.</p>

¹ The default setting is marked in **bold**.

Parameter	Display	Setting range ¹
Behavior in calibration mode	CAL.TE	0 = Concurrent 1 = Current status is maintained
Response in case of error	ERR.TE	0 = LOW (e.g. 0 V) 1 = HIGH (e.g. 10 V) 2 = LOW NAMUR (1.4 V / 3.4 mA) 3 = HIGH NAMUR (10.7 V / 22 mA)
Manual mode of the analog output - temperature	SIM.TE	OFF = no manual mode 0...22 mA or 0...10.7 V

¹ The default setting is marked in **bold**.

8.3.3 Calibration settings

Parameter	Display	Setting range ¹
Rapid access to calibration with and (P) keys	CAL.LVL	0 = Rapid access disabled 1 = Rapid access enabled
Calibration interval	CA.INT	0 ... 999 days

9 Calibration

9.1 General information

The zero point (intercept) and slope of pH sensors stray from copy to copy. During the service life of the sensor, up to the time it must be replaced by a new sensor, the zero point and slope change. To allow for precise measurements, the transmitter must be adjusted (calibrated) to the current sensor parameters. The calibration is performed using buffer solutions.

Only the zero point needs to be calibrated for redox sensors.

9.1.1 When is calibration required?

The electrochemical sensors should be cleaned and the transmitter should be calibrated at regular intervals (depending on the measuring medium)!

9.2 Activating and starting calibration mode



During the calibration process, the display flashes.
The analog outputs respond as they were calibrated on the USER LEVEL / ANALOG OUTPUT x / FOR CALIBRATION.

The response of the relay depends on the configuration of the switching output!



Calibration can be cancelled at any time with the EXIT key. Old calibration data will not be lost.

Calibration is performed using the instrument keys.

The zero point and slope of a sensor can also be entered manually. This should only be done in exceptional cases. Some sensors come with a test report that specifies the zero point and slope. These values simply provided documentation that the sensor was in proper condition upon delivery. Since these values change during storage, they are not suitable for manual entry. We **always** advise performing calibration with buffer solutions.

The timeout function is not active during calibration!

9.2.1 Starting calibration from the calibration level "CALIB"



Use the menu to switch to the calibration level (see Section 7.4 "Selecting levels", page 20 and Section 7.8 "Calibration level (CALIB)", page 24).

- * Ⓟ Press and hold (for more than 2 sec) / then select CALIB.
- * Ⓟ Press and hold (for less than 1 sec) / then enter code 110.
- * Confirm with Ⓟ,
continue with Section 9.4 "One-point or two-point calibration",
page 43.

9.2.2 Starting calibration with the hot key (rapid access)



Activation of the calibration mode by rapid access must be previously enabled:

Ⓟ > Press and hold for 2 seconds / Set ADMIN / CAL / CA.LVL to 1.

- * Press the Ⓟ and ▼ keys,
continue with Section 9.4 "One-point or two-point calibration",
page 43.

9.3 Canceling calibration and error messages



Calibration can be cancelled at any time with the EXIT key. Old calibration data will not be lost.

During the calibration process, the transmitter calculates the electrode parameters zero point and if applicable slope. If the calculated values fall outside the permissible parameter limits, an error message is generated.

For the permitted value ranges of parameters NULL and SLOPE see Section 8.1.1 "Measurement input - main value (submenu "PH")", page 26.

9.3.1 Zero point error



Parameter limits for NULL have been violated.

9.3.2 Slope error



Parameter limits for SLOPE have been violated.

9.3.3 General error during calibration



The parameter limits for NULL and SLOPE have been violated and/or the two calibration points Ref.1 and Ref.2 are too close to each other.

For two-point calibration of a pH sensor, the minimum spacing is 2 pH.

For two-point calibration of a redox sensor, the minimum spacing is 2 mV.

The greater the spacing, the more accurate the calibration.

9.3.4 Acknowledging errors

* Press the **(P)** keys or EXIT.

The error message is deleted.

The faulty parameters NULL and/or SLOPE are not saved.

The instrument continues working with old calibration data.

9.3.5 Additional measures

* Check the quality and condition (age) of the buffer solutions.

* Check whether the sensor is dirty or needs to be replaced.

* Check whether the sensor plug is moist or the wiring is faulty.

* Observe the minimum spacings for buffer or reference values.

9.4 One-point or two-point calibration

For one-point calibration, the transmitter is only adjusted to the zero point of the sensor.

In two-point calibration the transmitter is adjusted to both the zero point of the sensor and its slope. We expressly recommend two-point calibration!

9.4.1 Selecting one-point calibration

Select CAL I-PT.

For more details see Section 9.5.1 "One-point calibration (zero point)", page 44.

9.4.2 Selecting two-point calibration

Press the \blacktriangledown key and select CAL 2-PT.

For more details see Section 9.5.2 "Two-point calibration (zero point and slope)", page 45.

9.5 Calibrating a pH measurement chain

9.5.1 One-point calibration (zero point)



* Confirm the selection with \textcircled{P} .



Display or editing option of the buffer temperature.

* Confirm the selection with \textcircled{P} .



The first reference value is then measured.

* Wait until the measurement value has stabilized.
Confirm the measurement value with \textcircled{P} .



Flashing

- * Enter the actual buffer value with or and confirm with .



The calculated zero point of the measurement chain appears.

- * Accept the value with or press to cancel the calibration.

The instrument goes into measurement mode.



If an error message appears, see Section 9.3 "Canceling calibration and error messages", page 42.

9.5.2 Two-point calibration (zero point and slope)

Calibrate zero point and slope.



The buffer solutions (reference solutions) used for calibration must differ by at least 2 pH!
During the calibration, the temperature of the two buffer solutions must be identical and remain constant!



- * Confirm the selection with (P).



Display and editing option of the buffer temperature.

- * Confirm the selection with (P).



The first reference value is then measured.

- * Immerse the measurement chain in the first buffer (for example pH 7.00)
- * Wait until the measurement value has stabilized.
Confirm the measurement value with (P).



Flashing

- * Enter the actual buffer value with (▲) or (▼) and confirm with (P).

-
- * Remove the measurement chain from the first buffer and rinse with distilled water.
 - * Immerse the measurement chain in the second buffer (for example pH 4.00)



- * Wait until the measurement value has stabilized. Confirm the measurement value with \textcircled{P} .



Flashing

- * Enter the actual buffer value with \blacktriangle or \blacktriangledown and confirm with \textcircled{P} .



The calculated zero point (top line) and the calculated slope (bottom line) appear.

- * Accept the values with \textcircled{P} or press $\textcircled{\text{EXIT}}$ to cancel the calibration.

The instrument goes into measurement mode.



If an error message appears, see Section 9.3 "Canceling calibration and error messages", page 42.

9.6 pH antimony measurement chain

Antimony measurement chains are calibrated similarly to "normal" pH measurement chains, see Section 9.5 "Calibrating a pH measurement chain", page 44.

9.7 Redox measurement chain

9.7.1 General information

The instrument offers two calibrating options for adjusting it to the redox measurement chain.

- One-point calibration
If "mV" was configured as UNIT.
- One-point calibration
If "mV" was configured as UNIT.



The display flashes during calibration.

The analog outputs respond the same way as on USER LEVEL / ANALOG OUTPUT x / FOR CALIBRATION.

The response of the relay depends on the configuration of the switching output!

9.7.2 One-point calibration (recommended calibration)

Calibration of the zero point.



- * Confirm the selection with (P).
- * Rinse off the measurement chain with distilled water or clean if necessary (see operating instructions for electrode).
- * Immerse the measurement chain in the test solution (e.g. 468 mV).



The reference value is then measured.

- * Wait until the measurement value has stabilized.
- * Confirm the measurement value with \textcircled{P} .



Flashing

- * Enter the actual buffer value with \blacktriangle or \blacktriangledown and confirm with \textcircled{P} .

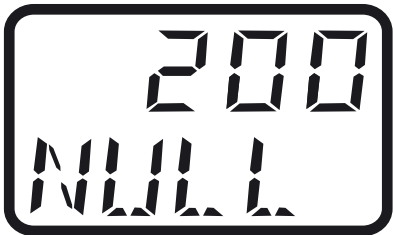

The calculated zero point of the measurement chain appears.

Accept the value with \textcircled{P} or press $\textcircled{\text{EXIT}}$ to cancel the calibration.

The instrument goes into measurement mode.



If an error message appears, see Section 9.3 "Canceling calibration and error messages", page 42.

9.7.3 Two-point calibration

In this type of calibration the display range can be scaled freely from 0 to 100%.

Example:

A span of -10 mV ... +1000 mV can be scaled to 0 ... 100% werden.
The zero point can fall within the range of -999 ... +999 mV.



Two different reference fluids must be used for the calibration. The redox voltage of a measurement solution is **not** temperature-dependent!



Confirm the selection with (P).



The first reference value is then measured.

- * Immerse the measurement chain in the first solution (for example 59 mV)
- * Wait until the measurement value has stabilized.
Confirm the measurement value with (P).



Flashing

-
- * Enter the desired value with \blacktriangle or \blacktriangledown (for example 20) and confirm with \textcircled{P} .
 - * Remove the measurement chain from the first solution and rinse with distilled water.
 - * Immerse the measurement chain in the second solution (for example 295 mV).

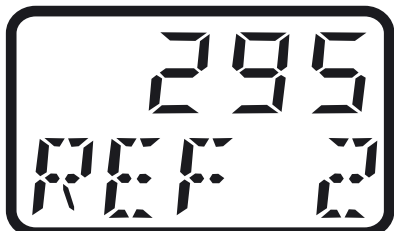

- * Wait until the measurement value has stabilized. Confirm the measurement value with \textcircled{P} .



Flashing

- * Enter the desired value with \blacktriangle or \blacktriangledown (for example 80) and confirm with \textcircled{P} .

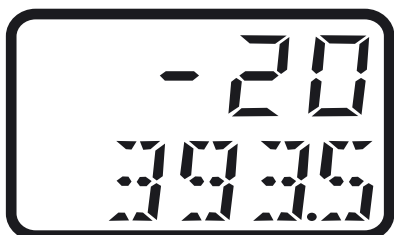

- * The calculated zero point (top line in mV) and the calculated slope (bottom line) appear.

Accept the values with \textcircled{P} or press $\textcircled{\text{EXIT}}$ to cancel the calibration. The instrument goes into measurement mode.



If an error message appears, see Section 9.3 "Canceling calibration and error messages", page 42.

10 Analog output



Analog outputs are configured on the user level (USER) or on the administrator level (ADMIN) in PH.OUT (pH or redox output) and TE.OUT (temperature output); see Section 7.5 "User level (USER)", page 21.

10.1 Behavior of the output signal during calibration

Two options are possible, "Concurrent" and "Unchanged" (constant).

10.2 Behavior of the output signal in case of error

If one of the following errors occurs, the output signal assumes the defined status (see Section 10.3 "Output signal in case of error", page 53):

Analog output of pH value / redox voltage with non-active temperature compensation

- Underrange pH value / redox voltage
- Overage pH value / redox voltage

Analog output of pH value / redox voltage with active temperature compensation

- Underrange pH value / redox voltage
- Overage pH value / redox voltage
- Underrange temperature
- Overage temperature

Analog output - temperature

- Underrange temperature
- Overage temperature

10.3 Output signal in case of error

Depending on the configuration, the output signal may assume the "LOW" or "HIGH" state in case of error.

Output signal nominal	Output signal HIGH	Output signal LOW
0...20 mA	22.0 mA	0 mA
4...20 mA	22.0 mA	3.4 mA
0...10 V	10.7 V	0 V
2...10 V	10.7 V	1.4 V

10.4 Output signal when leaving the scaling range

When leaving the scaling range, the output returns a proportional signal up to a defined limit (in compliance with NAMUR NE43). The limits are listed in the table below:

Value below scaling range	In the scaling range	Scaling range was exceeded
0.0 mA	0...20 mA	20.5 mA
3.8 mA	4...20 mA	20.5 mA
0.0 V	0...10 V	10.2 V
20.5 mA	20...0 mA	0.0 mA
20.5 mA	20...4 mA	3.8 mA
10.2 V	10...0 V	0.0 V
1.8 V	2...10 V	10.2 V
10.2 V	10...2 V	1.8 V

10.5 Manual mode of the analog output

For test purposes or startup, a constant analog signal can be generated by the instrument (see also Section 11.3 "Manual mode of the relay output", page 57).



After a power supply failure, manual mode is deactivated.

11 Relay output

11.1 Relay behavior

Depending on the setting, the JUMO ecoTRANS pH 03 monitors a limit value.

11.2 Binary output 1 (submenu "BIN.1")

Setting options

- 0 = **No function** (default setting)
- 1 = Window contact main value (active inside a window)
- 2 = Window contact main value (active outside a window)
- 3 = Max contact main value (normally open (NO), similar to LK7)
- 4 = Min contact main value (normally closed (NC), similar to LK8)
- 5 = Window contact temperature (active inside a window)
- 6 = Window contact temperature (active outside a window)
- 7 = Max contact temperature (normally open (NO), similar to LK7)
- 8 = Min contact temperature (normally closed (NC), similar to LK8)
- 9 = Error output (every device error causes the relay to switch)
- 10 = Calibration timer elapsed

Contact function for settings 1 and 5

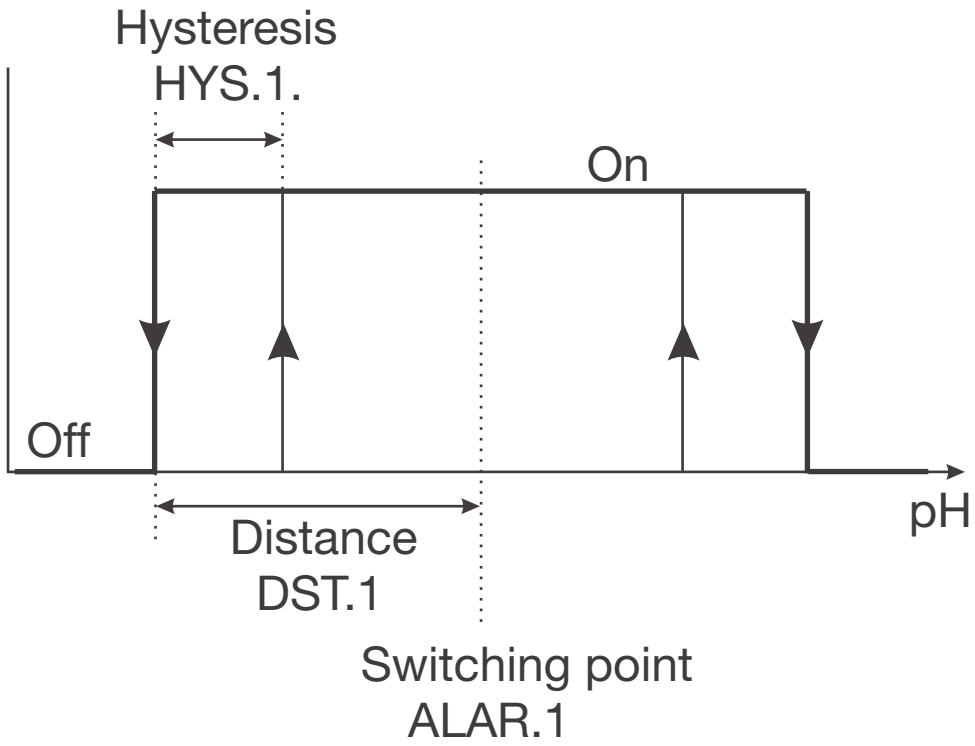

Contact function for settings 2 and 6

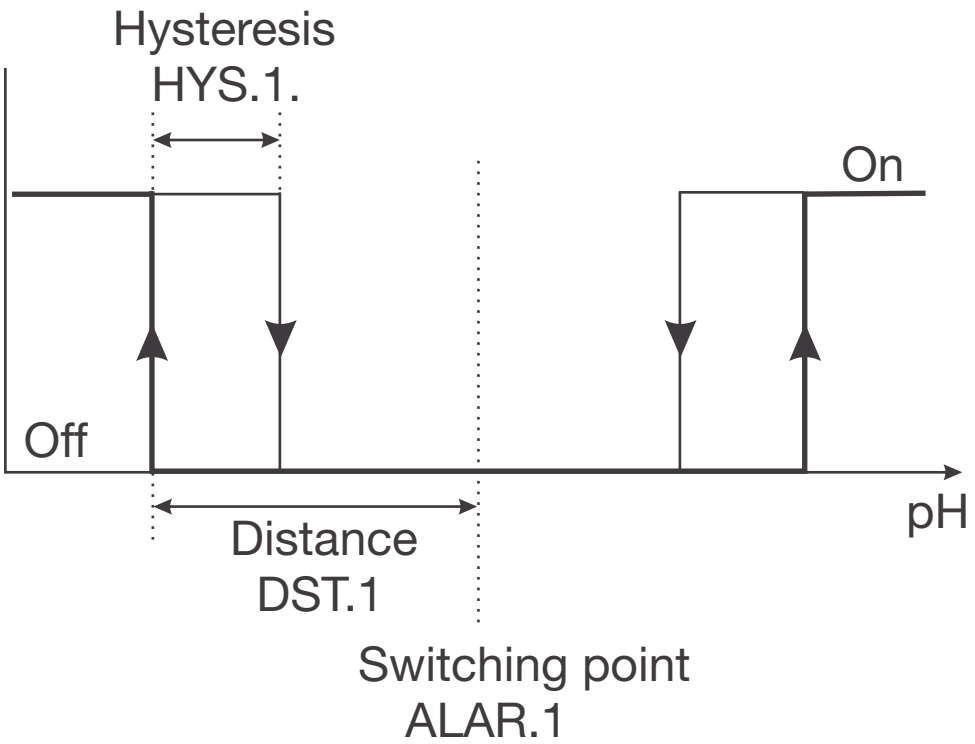

Contact function for settings 3 and 7

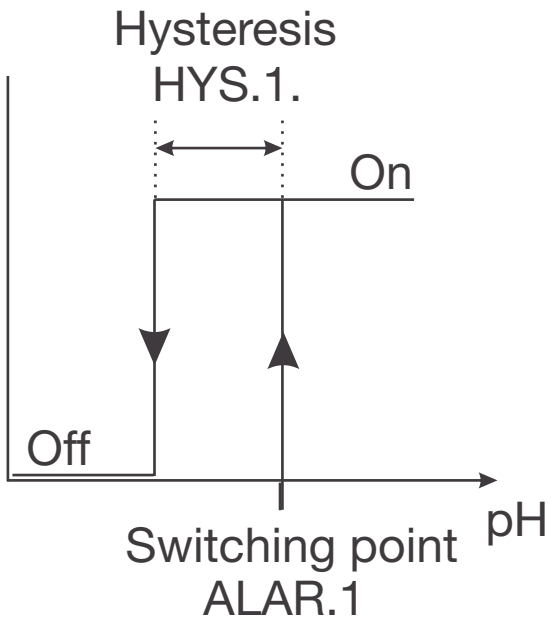

Contact function for settings 4 and 8

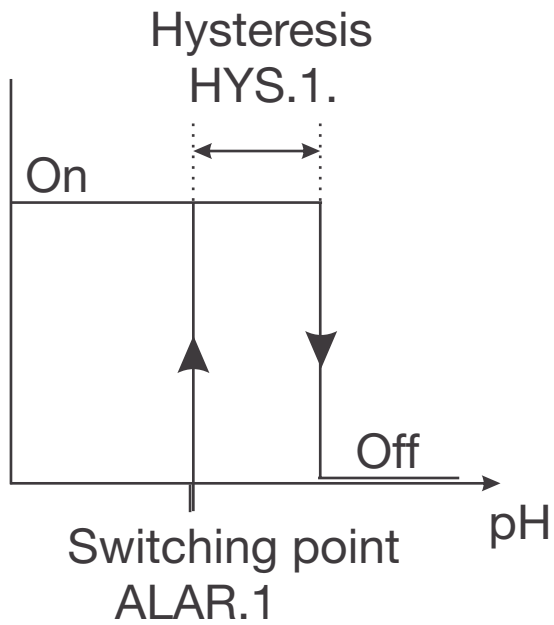

11.3 Manual mode of the relay output

For test purposes or when starting up systems, a **constant** signal can be generated by the transmitter.

Manual mode can be set with parameter: USER / BIN.1 / SIM.1 to

- 0 = inactive
- 1 = active => LED "K1" is lit
- 2 = No manual mode.

Indication of manual mode

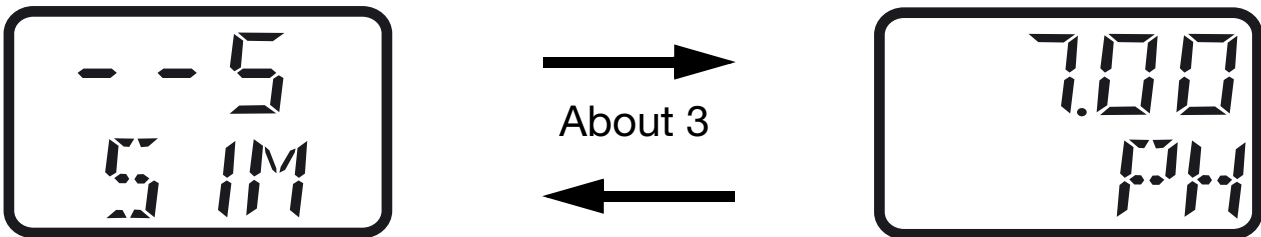

If one of the outputs is in manual mode, this is indicated in the change to process value display by an "S" or "-".

- S The relevant output is in manual mode.
- The relevant output is **not** in manual mode.

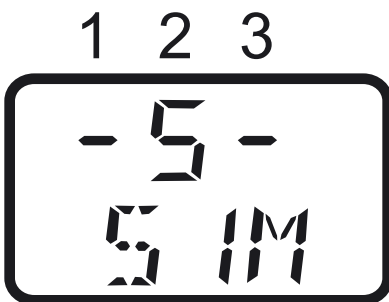

1st place Analog output - pH/redox voltage

2nd place Analog output - temperature

3rd place Binary output 1

In the example above, the analog temperature output is in manual mode. No other outputs are in manual mode.

When the user exits manual mode, the output signal immediately assumes the value proportional to the pH value/redox voltage or the temperature process value.

After "Supply voltage On" manual mode is always deactivated.

11.4 Behavior of the relay during calibration

The behavior of the relay with the parameter:

USER / BIN.1 / CAL.1 set to

0 = Relay inactive

1 = Relay active

2 = Relay unchanged

(during calibration the relay status remains set to the status that was valid before the calibration process)

11.5 Pulse function of the relay output

The limit comparator is reset after an adjustable "pulse time." The parameter for this is: USER / BIN.1 / T.PUL1 .

It can be set from 0 = 0 seconds (no pulse function)

to 999 = 999 seconds.

LED "K1" is lit red as long as the switching condition is met.



No OFF delay is possible in pulse mode.

Triggering condition is longer than pulse duration

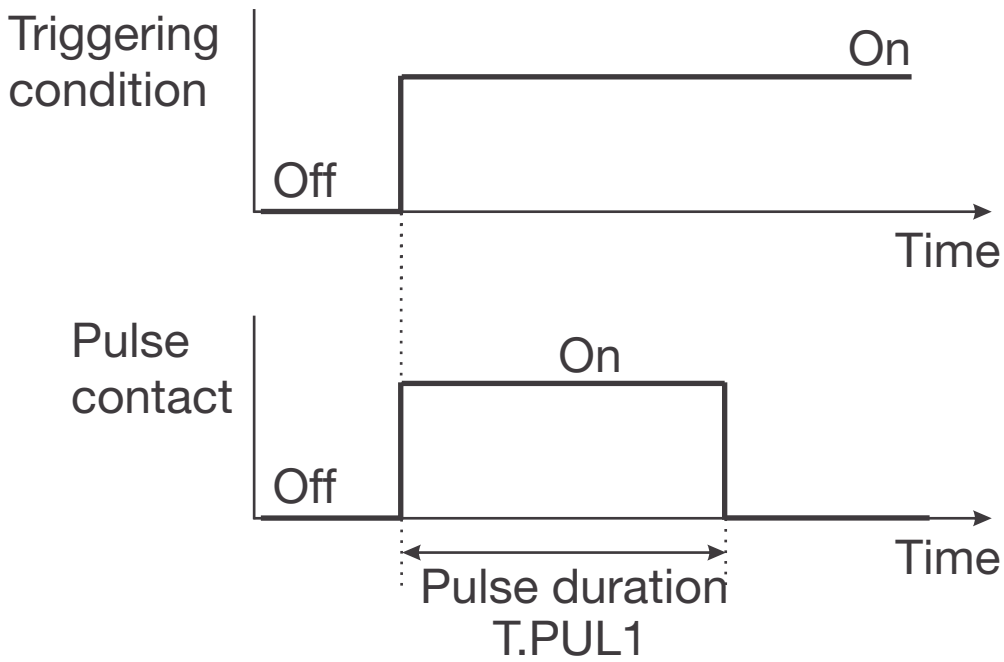

Triggering condition is shorter than pulse duration

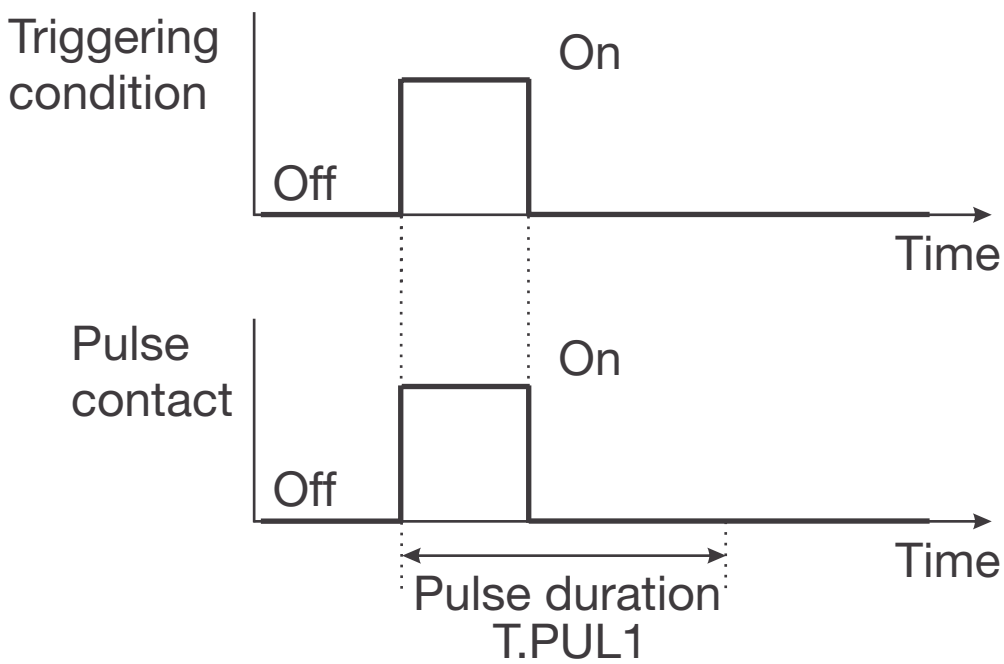

11.6 Behavior of the relay in case of error

The behavior of the relay can be adjusted with the following parameters:

USER / BIN.1 and ERR.1 set to

0 = Relay inactive

1 = Relay active

2 = Relay unchanged

("frozen": the relay status remains set to the status that was valid before the error)

Function	pH value redox voltage		Temperature	
	Under- range	Over- range	Under- range	Over- range
Limit comparator pH/redox voltage without temperature compensation	x	x		
Limit comparator pH/redox voltage with temperature compensation	x	x	x	x
Limit comparator temperature			x	x
Calibration timer elapsed	x	x	x	x
Error output	x	x	x	x

11.7 Error detection

The relay output is active for the following errors:

Limit comparator for pH value/redox voltage with non-active temperature compensation

- Underrange pH value/redox voltage
- Ovrerrange pH value/redox voltage

Limit comparator of pH value/redox voltage with active temperature compensation

- Underrange pH value/redox voltage
- Overage pH value/redox voltage
- Underrange temperature
- Overage temperature

Limit comparator - temperature

- Underrange temperature
- Overage temperature

Calibration timer

- Timeout

12 Display and LED messages

12.1 Operating states of JUMO ecoTrans pH 03

Two LED indicate operating states

Instrument status	Red LED (top)	Yellow LED (bottom)
Normal mode	Off	On if LC1 is active
Error	Flashing	On if LC1 is active
Initialization	Off	Off

12.2 Underrange

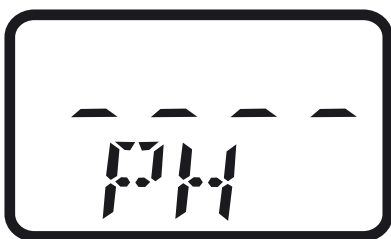

Value is below lower measurement range limit (ORP means redox).

12.3 Overrange

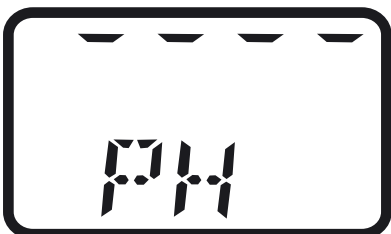

Measurement range exceeded (ORP means redox).

12.4 Broken sensor

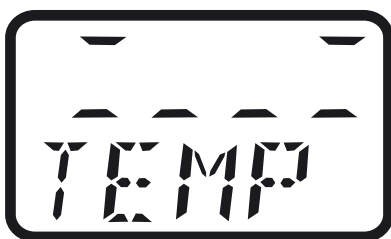

Broken sensor, wrong or no temperature sensor connected; see Section 8.1.2 "Measurement input - temperature (submenu "TEMP")", page 28.



If no automatic temperature compensation or temperature measurement is required parameter SENS.T must be set accordingly; see Section 8.1.2 "Measurement input - temperature (submenu "TEMP")", page 28.

12.5 Short-circuit

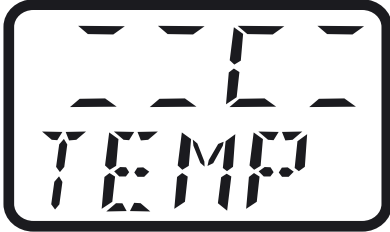

12.6 Initialization of dependent parameters

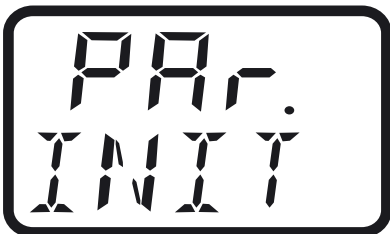

After a parameter has been changed, other dependent parameters are automatically changed.



Please check all dependent parameters!

12.7 Calibration timer elapsed

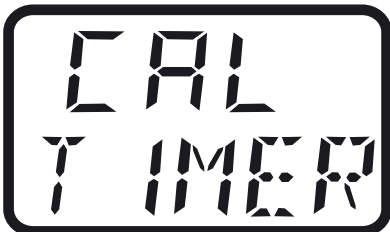

Depending on specifications (for example of the equipment manufacturer), calibration of the measurement chain should be performed.

After a correct calibration, the calibration timer is reset and automatically restarted.

13 Operation via setup interface

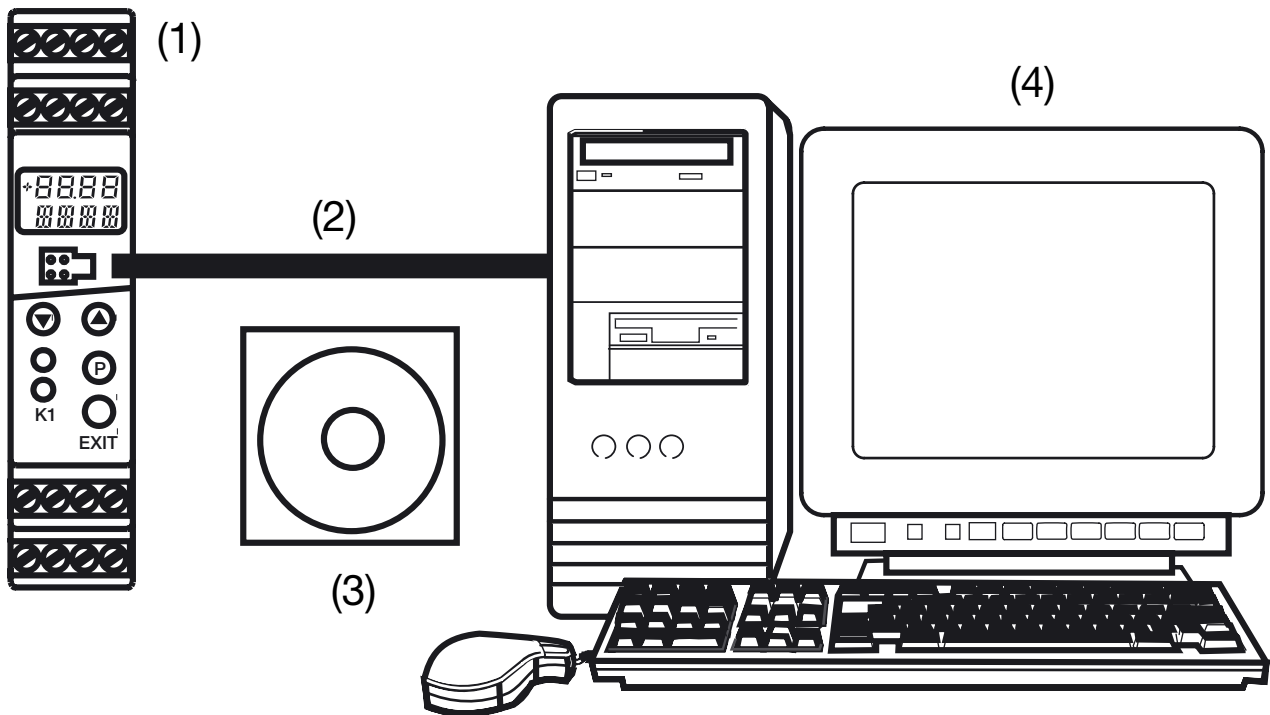

- (1) JUMO ecoTRANS pH 03
- (2) PC interface line (optional accessory)
- (3) JUMO PC setup software, multilingual D / GB / F (optional accessory)
- (4) PC or Notebook with USB interface
operating system: Windows 2000[®], Windows XP[®] or Windows NT[®] 4.0 and up, Windows Vista[®]

13.1 Operation with PC setup program

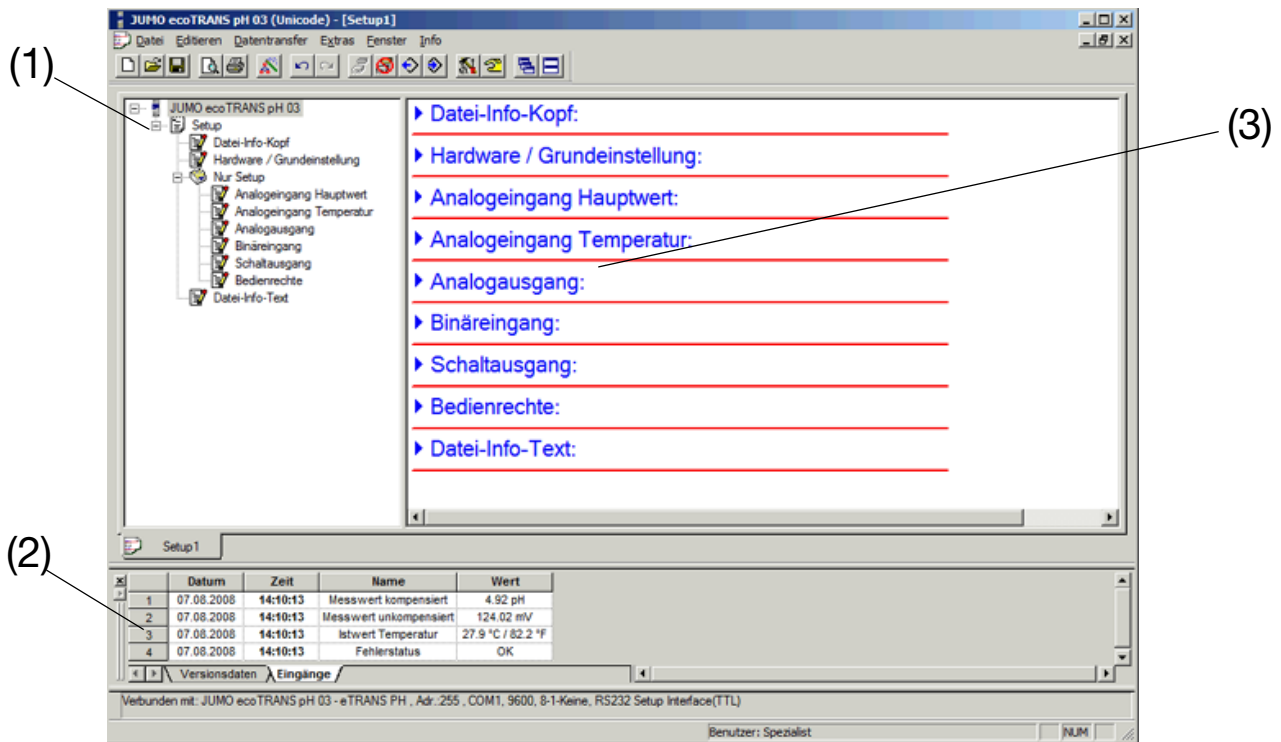

(1)	<p>Navigation tree</p> <p>The navigation tree provides fast access (double click) to individual setting options.</p>
(2)	<p>Diagnostics window</p> <p>As soon as a connection is established with an instrument, current data is displayed here.</p>
(3)	<p>Working area</p> <p>Clicking the arrow (▶) shows possible settings.</p> <p>Double clicking the text opens the appropriate editing window.</p>

14 Technical data

Inputs

Analog input 1 (pH / redox)

- Electrodes
- Glass or metal electrodes with isolated reference electrode
- Antimony electrode

Measurement ranges for pH / redox

-2 ... 16 pH or
-1500 ... +1500 mV

Accuracy for pH / redox

± 1% of the measurement range

Analog input 2 (temperature)

- Resistance thermometer Pt100 or Pt1000

The temperature sensor can be connected in a 2-wire circuit.

Measurement display can be switched between °C / °F

Temperature offset for analog input 2

A process value can be corrected by an offset in the range from -20 ... +20°C.

Temperature measurement range

-10 ... +150°C or 14 ... 302°F

Deviation from characteristic temperature curve

for Pt 100 / Pt 1000: ≤ 1.5 K

Outputs

Two analog outputs:

Freely configurable:

0(2) ... 10V $R_{load} \geq 2 \text{ k}\Omega$ or
10 ... (2)0V $R_{load} \geq 2 \text{ k}\Omega$ or else

0(4) ... 20mA $R_{load} \leq 400 \Omega$ or

20 ... (4)0mA $R_{load} \leq 400 \Omega$

galvanically isolated from inputs:

$\Delta U \leq 30V$ AC or $\Delta U \leq 50 V$ DC

Scope of scaling at least 10% of the scope of the measurement range

deviation from the characteristic curve of the output signal

$\leq 0.075\%$ of the measurement range

Relay output:

Switching contact

switching capacity: 8 A, 250 V AC or 8 A, 24 V DC

with resistive load

contact life: > 100,000 operations at normal load

Key general parameters

A/D converter

14-bit resolution

Sampling time

500ms = 2 measurements / second

Effect of ambient temperature

$\leq 0.6\%$ / 10 K

Measuring circuit monitoring

Input 1(main value): out-of-range

Input 2 (temperature): out-of-range, sensor short circuit, broken sensor.

In case of error, the outputs assume a defined (configurable) state.

Data backup

EEPROM

Supply

DC 20 ... 30 V, residual ripple < 5 %,
power consumption ≤ 4 W,
with reverse polarity protection.

Operates only on SELV or PELV circuits.

Electrical connection

Screw terminals up to 2.5 mm²

Operating temperature range

0 ... +50°C

Functional temperature range

-10 ... +60°C

Storage temperature range

-20 ... +75°C

Climatic rating

Rel. humidity ≤ 75% no condensation

Enclosure protection (complies with EN 60 529)

IP 20

Electrical safety

Complies with EN 61 010
air gaps and creep zones for
- Overvoltage category II
- Pollution degree 2

Electromagnetic compatibility

Complies with EN 61 326
Interference immunity: To industrial requirements
Interference emission: Class B

Enclosure

DIN rail enclosure made of PC (polycarbonate)

Mounting

On DIN rail 35mm x 7.5mm to DIN EN 60 715

Installation position

Any

Weight

Approx. 150g

15 Environment/disposal

Defective instruments can be sent to JUMO for proper disposal.



JUMO GmbH & Co. KG

Hausadresse:

Moritz-Juchheim-Straße 1
36039 Fulda, Germany

Lieferadresse:

Mackenrodtstraße 14
36039 Fulda, Germany

Postadresse:

36035 Fulda, Germany

Telefon: +49 661 6003-0

Telefax: +49 661 6003-500

E-Mail: mail@jumo.net

Internet: www.jumo.net

Bei technischen Rückfragen - Telefon-Support Deutschland:

Telefon: +49 661 6003-300 oder -653 oder -899

Telefax: +49 661 6003-881729

E-Mail: service@jumo.net

JUMO Mess- und Regelgeräte Ges.m.b.H.

Pfarrgasse 48

1232 Wien, Austria

Telefon: +43 1 610610

Telefax: +43 1 6106140

E-Mail: info@jumo.at

Internet: www.jumo.at

JUMO Mess- und Regeltechnik AG

Laubisrütistrasse 70

8712 Stäfa, Switzerland

Telefon: +41 44 928 24 44

Telefax: +41 44 928 24 48

E-Mail: info@jumo.ch

Internet: www.jumo.ch