

# MODEL: SP secure

(Combustible Gas Leak Detector)

# Operating Manual



---

## Guarantee and Repair

Senko Co., Ltd. guarantees the products of SP series for 24 months from the shipping date and repairs or replaces the defected product during warranty period at no cost. Nevertheless, Senko is not responsible for the following cases and would not repair or replace the product at no cost, such cases as the product has been purchased through the route that Senko does not approve, or as the product has been damaged or deformed mechanically by misuse of the user, or as the product has not been calibrated or replaced the parts according to processes in the operating manual.

In the event that any defect or issue of the product occurred during warranty period, Senko will cover all the expenses except transportation fee. After the period of warranty, the expenses of repair or replacement of the product and transportation will be in principle borne by the user. Senko will not be responsible for any indirect occurrence or accident and/or damage during the use of the product, and the guarantee shall be limited to the replacement of parts and product. The guarantee is applied only to the users who purchased the product at Senko's authorized dealers or agents, and the guaranteed repair is to be performed by the expert engineers of Senko's authorized aftercare center.

## Introduction

SP secure is a portable gas leak detector necessary to secure user's safety and protect industrial facilities by detecting leakage of gas in earlier stage at the dangerous work environment where risk of explosion always exists. As it is configured with two buttons only, the method of operation and sensor calibration is easy and convenient. Also the %LEL and concentration value of inflammable gas (LPG/LNG, hydrogen, etc) can be displayed on a digital LCD monitor.

For the safety of users, workers and operators are to be fully alerted about the alarm circumstances by the loud alarm sound and warning icon displayed on LCD monitor when gas concentration is detected in excess of regulatory standard. In addition, a suction pump is built-in it and also featured with the function of On/Off for the pump and alarm sound so that the user can set up alarm values to properly meet with the circumstances involved and the alarm value such set up can be adjusted to best fit to the type of gas and circumstances of leakage. SP secure provides quick response to inflammable gas and also prevents in advance workers from the explosion by the leakage of gas and high risk of asphyxiation that may be resulted by the exposure to toxic gas for a certain period of time.

---

## **Contents of Operating Manual**

<b>Product Specification</b>	<b>3</b>
<b>Names and Functions of Exterior</b>	<b>4</b>
<b>Start of Operation</b>	<b>5</b>
<b>Operation Method</b>	<b>6</b>
<b>Calibration</b>	<b>7</b>
<b>Method of Alarm Set and Display</b>	<b>9</b>
<b>Applicable Battery and Power for Recharge</b>	<b>12</b>
<b>Battery &amp; Sensor replacement</b>	<b>13</b>
<b>Operation Flow Chart</b>	<b>14</b>
<b>Notice for User</b>	<b>16</b>

# Product Specification

Model	SP secure		
Detecting Gas	LNG, LPG	Hydrogen(H <sub>2</sub> )	Xylene
Sampling Method	Internal Sampling Pump, flow rate 0.5 liter/min.		
Sensor Type	Catalytic	Electrochemical	IR
Detecting Range	0~100%LEL	0~1000ppm	0~100%LEL
Response Time(T <sub>90</sub> )	Within 10 sec.	Within 60 sec.	Within 90 sec.
Resolution	1 %LEL	1 ppm	1 %LEL
Display	Digital LCD(Alarm, Buzzer, Pump On-off, Battery, Backlight)		
Alarm	Buzzer alarm & LCD Display		
Gas Concentration Display	0~1% LEL – digital bar 1~100% LEL – numerical display	0~20 ppm – digital bar 0~1,000 ppm – numerical display	0~1% LEL – digital bar 1~100% LEL – numerical display
Explosion Proof	Ex d ia IIB T3		
Operating Temperature	- 20°C ~ 50°C		
Power	Recharger or AA Alkaline battery 3ea		
Continuous Operation	More than 12 hours		
Dimensions / Weight	55m(W) x 241mm(H) x33 mm(D) / 260g		
Standard Accessories	Protect Cover, Adapter for charge		
Options	Extension Probe(5M/10M/20M)		

# Names and Functions of Exterior

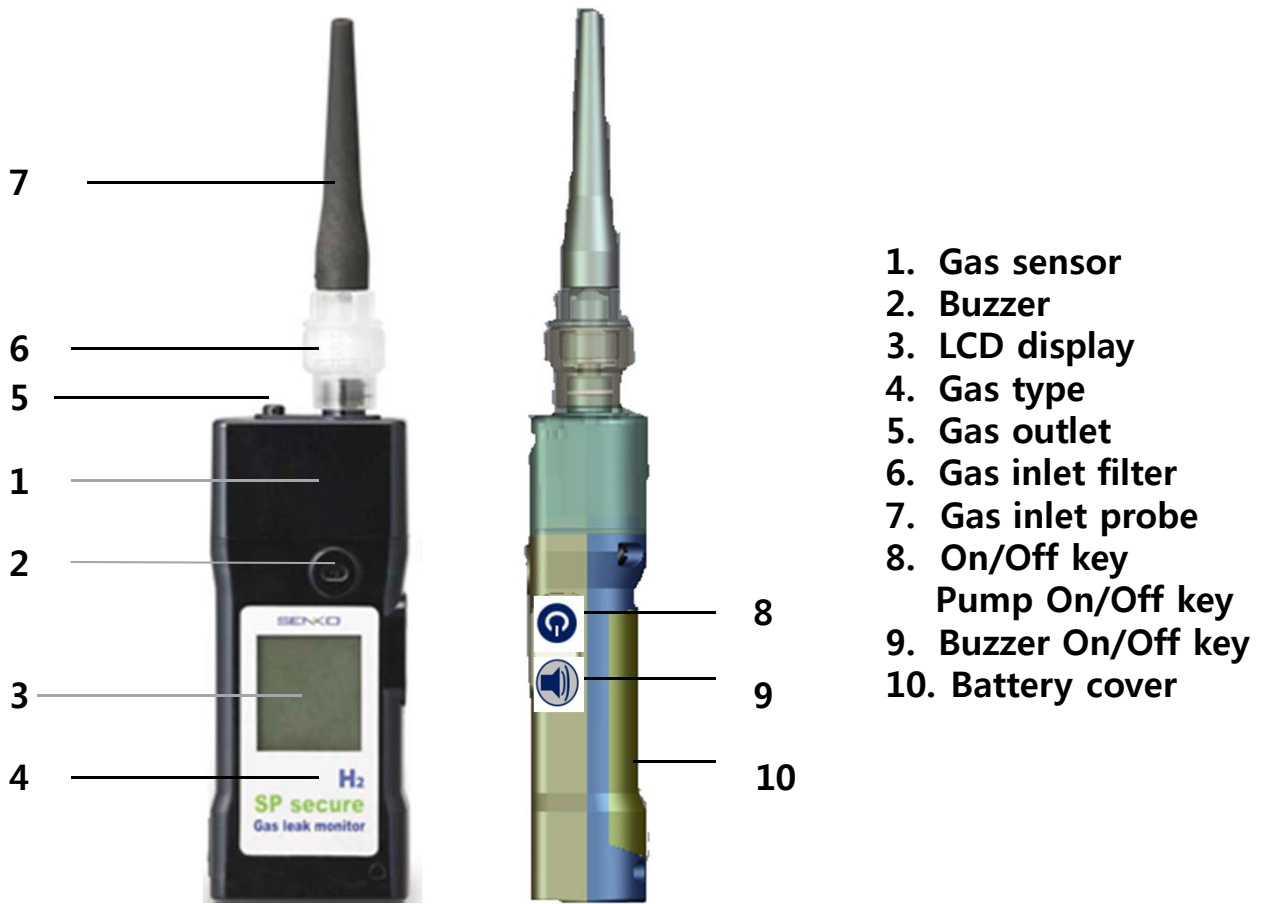

# LCD display symbols

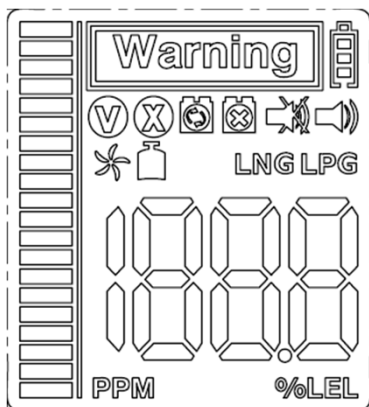

- V** test pass
- X** Test Failure
- LNG** Detecting gas mode
- LPG** Detecting gas mode
- [Muted Speaker]** Buzzer off
- [Speaker]** Buzzer on
- [Pump On]** Sampling pump on
- [Pump Off]** Sampling pump off
- [Battery]** Battery
- [Star]** Fresh air calibration
- [Gas Canister]** Single gas calibration

---

# Start of Operation

## Power-On of Device



Press Power Key and power is turned on displaying 3,2 and 1 in order and all icons on LCD shall be blinking three times. Afterwards during the device is being stabilized, countdown is displayed on the screen. When stabilization of the device is completed, **V** mark appears with alarm sound and then converted to Gas Detection Mode.

Under normal status, **V** mark disappears in about 30 seconds and concentration of the gas detected of the moment is indicated. In the events that stabilization of the device fails, it would not convert to Gas Detection Mode, blinking the mark **V** with alarm sound. In this case, calibration of sensor or A/S of the device **X** is required.

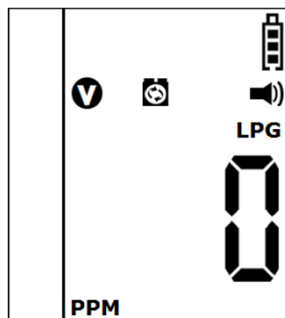

Test Success

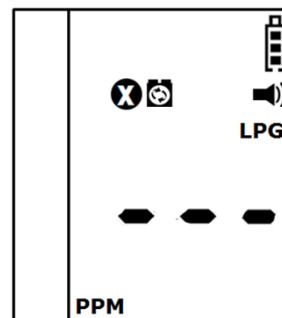

Test Fail

## Power Off of the Device



Press Power Key for 3 seconds and the digit 3,2 and 1 shall appear on the monitor in turn. After then power is turned off.

Caution : Appropriate calibration of the device is always required prior to operation at the work site. Make sure if the device shows proper response to the pertinent gas and if the part sucking gas is not blocked with foreign materials that interfere the gas detection.

# Method of Operation

## Measure Mode

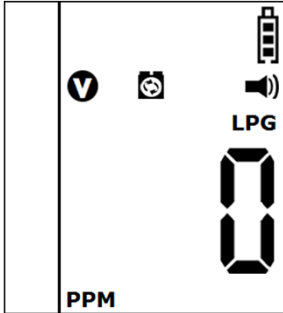

In case of LPG/LNG Detector, the device is converted to Gas Measure Mode as shown below when power button is turned on. Gas Measure Mode indicates the concentration of gas, operating status of suction pump, alarm sound On/Off status, battery level on LCD and it displays the concentration of flammable gas by %LEL and by PPM unit for Hydrogen. In the event that gases are detected, it indicates the value of concentration in real time and, if it exceeds the 1st and 2nd alarm standard, the measured value shall be displayed blinking repeatedly along with **Warning!** mark and LO or HI indication.

The gas leakage detector raises an alarm along with digital bar when gas leakage is detected even in small amount, and the concentration value shall be reduced and alarm also shall be ceased when moved out to safe region where normal concentration value is measured. The alarm sound raised by the detection in the beginning stage can be stopped (OFF) with the Alarm Sound Off Button but the 1st and 2nd alarm sound can not be stopped. (Once alarm sound is raised, the **Warning!** mark shall not be disappeared even though the device is moved out to safe region (Can delete it by the OFF of Power Key). When the concentration value of the gas measured exceeds the maximum measuring range, it is indicated as the max value and it will be kept blink with one second interval. Also alarm sound relevant to the standard of 2<sup>nd</sup> alarm shall be raised along with indication.

## ON/OFF function of Suction Pump and Alarm Sound

Suction pump is set to turn ON when power key is pressed. Press power key one more time to OFF suction pump. When power key is input once again, the function of suction pump returns to ON state as initially set. Alarm sound is also set to turn ON state when power key is pressed. All the following operations for ON/OFF of the Alarm Sound can be performed in the same way as that for suction pump above by using Alarm Sound key.

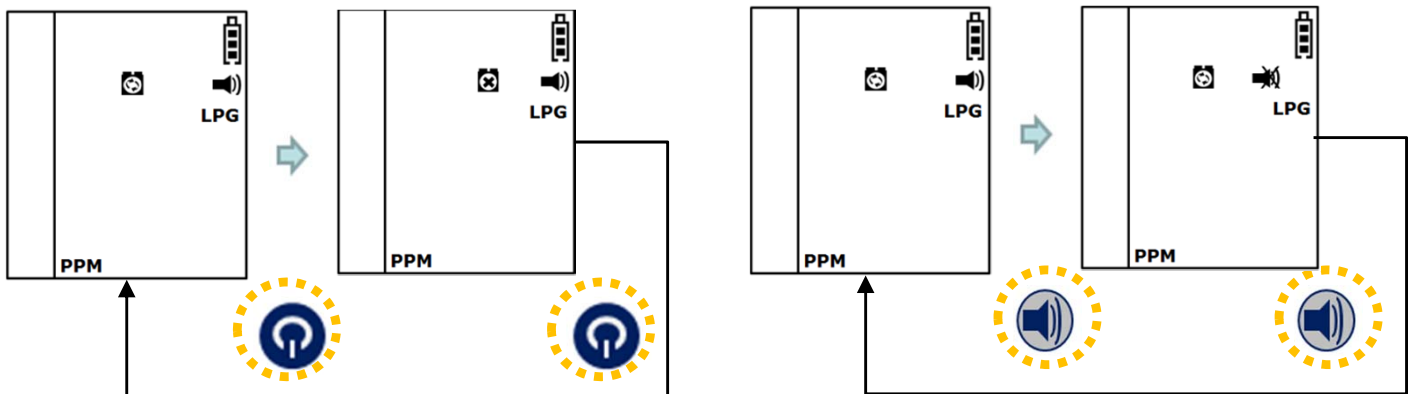

Caution: Gas leakage detection can not be properly performed if the Suction Pump key is laid in OFF state. As the setting of OFF mode is to save battery while the device is not in service, Suction Pump has to be set ON all the time during the measure of gas leakage.

# Calibration

Caution : The initial calibration before delivery of the product is performed by Senko Co. Ltd. As the calibrated values are stored in the device, incorrect calibration may reduce the accuracy of the product. Calibration is to be performed on monthly or quarterly basis in general. However, it can be adjusted depending on the frequency of use of the device.

## Fresh air Calibration

✳ icons shall blink if buzzer key is pressed for 3 seconds under the state power key is pressed simultaneously. Press power key at this state to enter into standby calibration mode. Calibration shall be completed in 10 second while processing countdown from 10,9,8...down to 3,2,1. When calibration is successfully completed, it returns to Gas Measure Mode with alarm sound after the ✓ icons being blinked for 3 seconds. In case standby calibration is failed, it returns to Gas Measure Mode with alarm sound after the ✕ icons being blinked for 3 seconds but the ✕ icons shall remain appeared in this case. If such occurrence happens repeatedly, please contact our agent or A/S center as the sensor is required to be replaced.

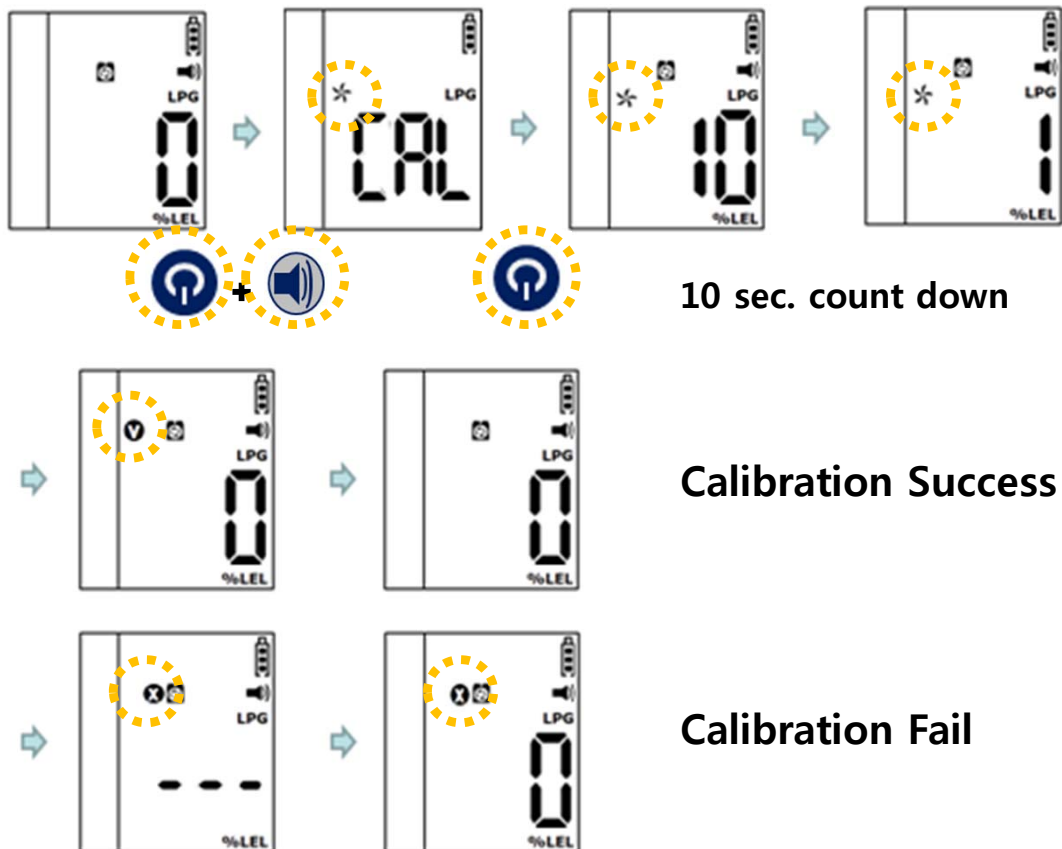



Caution : As the calibration is conducted under the assumption that the concentration of oxygen in fresh air is 29.9% and that of flammable gas is 0%LEL and the same of toxic gas is 0ppm, the fresh air calibration must be conducted in fresh air where no influences of other gases are effective. Hence, it is not desirable conducting fresh air calibration in a closed space and should be very careful not to conduct under the working environment where gases can be inhaled by workers or operators.

## Standard Gas Calibration

✳ icons shall blink when arrow key is pressed for 3 seconds under the state power key is pressed simultaneously. 🔊 icons shall blink when arrow key is input at this state. Standard gas calibration is initiated by pressing power key for 5 seconds at this time. Please be careful not to process calibration under the state that standard gas is not connected.

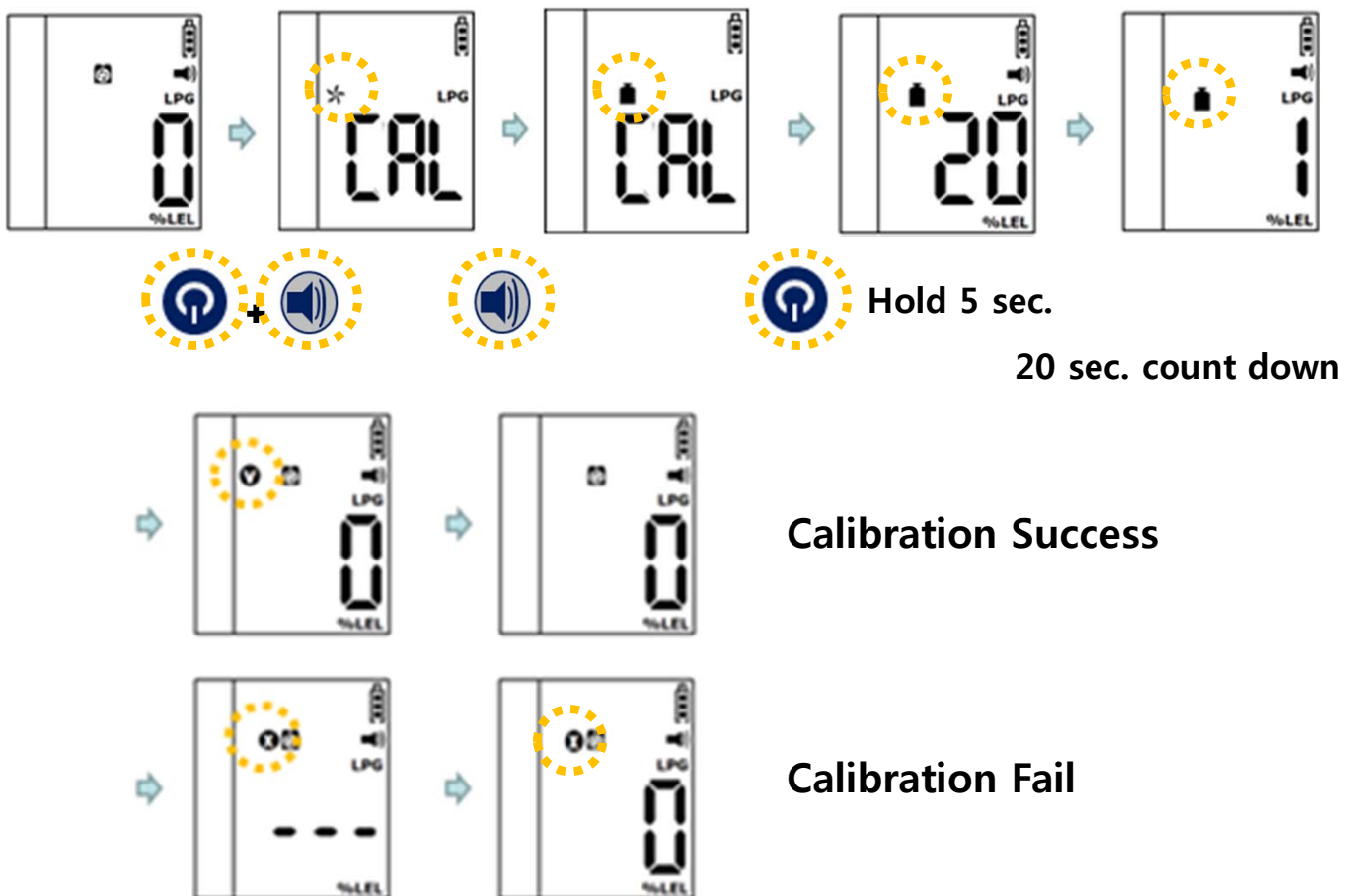

Once standard gas calibration is initiated, calibration shall be processed during the countdown for 20 seconds. In case calibration is normally processed, the ✓ icons shall blink with alarm sound and the concentration value of the gas connected for the moment shall be indicated. After then, when the connection of standard gas is blocked, the value of concentration measured for the moment shall be indicated. In case calibration is failed, it will return to Gas Measure Mode with alarm sound after the ✳ icons being blinked for 3 seconds. In this case, ✳ icons shall not be disappeared but kept appeared. If such occurrence happens repeatedly, please make inquiry with our agent or A/S center as the sensor is required to be replaced.











## Concentration of calibration gas for device

Gas	Combustible gas	Hydrogen	Xylene
Concentration	1%vol(Methane)	500 ppm	0.54%vol(Propane)

## Method of Alarm Set Up and Display

Caution : The values set for alarm of the device are set in conformity with the alarming standards internationally required by gases. Therefore, the set value for alarm by gases can be modified by the approval of the manager responsible for the area where the device is used.

### Indication of Alarm

Alarm	Standard for Alarm	LCD Display	Alarm Sound
1 <sup>st</sup> Alarm	When exceeding the value set for 1 <sup>st</sup> alarm	 and indicates LO	
2 <sup>nd</sup> Alarm	When exceeding the value set for 2 <sup>nd</sup> alarm	 and indicates HI	
Low	One level only left unused	 Blinking Battery	
Dead	is exhausted	 Blinking Battery	
Test Failure	Failure of sensor test Failure of calibration	Displays  Icon	

In case 1st alarm is raised and power key is pressed by a worker or operator who perceived the status of 1st alarm, the alarm sound only shall be stopped but the device shall still remain in operation state. When 2nd alarm is raised, the workers should quickly escape from the work site to safe region. Termination of alarm in this case is possible only by turning power key Off at a place where gas concentration indicates normal value (Alarm shall be continuously raised unless the power key is turned off at an area of normal concentration value). The alarm sound of 1st battery is same as that of the 1st alarm and, when power key is pressed, the alarm and vibration only shall be ceased but icons shall be kept blinking.

The alarm sound of 2nd battery is same as that of 2nd alarm and the blink of icons can not be deleted by the users. The alarm and power shall be off 10 seconds after the raise of alarm. In case of failure of test and calibration, **X** icons shall blink with alarm sound.

## Alarm Set Point

Gas	Combustible gas	Hydrogen	Xylene
1 <sup>st</sup>	20%LEL	100 ppm	20%LEL
2 <sup>nd</sup>	40%LEL	500 ppm	40%LEL

## Alarm Set Up

When power key and buzzer key is pressed for 3 seconds under the state of power OFF, **Warning!** icons shall appear blinking on LCD and indicates LO. Press power key one more time under this state to enter into alarm set up mode. When power key is pressed at this point, system shall be entering into the 1st alarm change mode and, when buzzer key is pressed, HI shall be displayed on the monitor and then moves to the 2nd alarm set up mode. In order to return to Gas Measure Mode without changing alarm set value, use buzzer key to move.

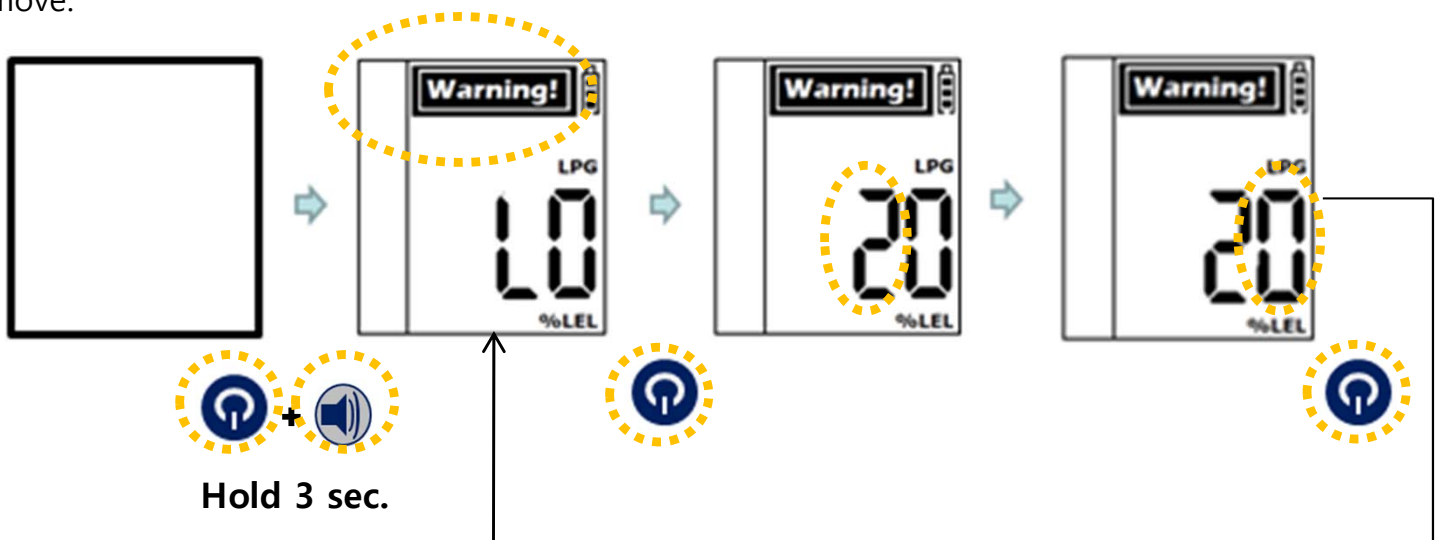

After setting the 1st alarm value, returns to the 1st alarm set up mode that is the alarm mode initially set. Use arrow key to enter into the 2nd alarm set up mode or to return to Gas Measure Mode. Method of 2nd alarm set up is same as that of the 1st alarm setting.

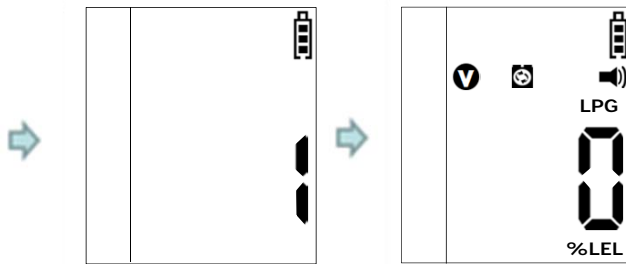
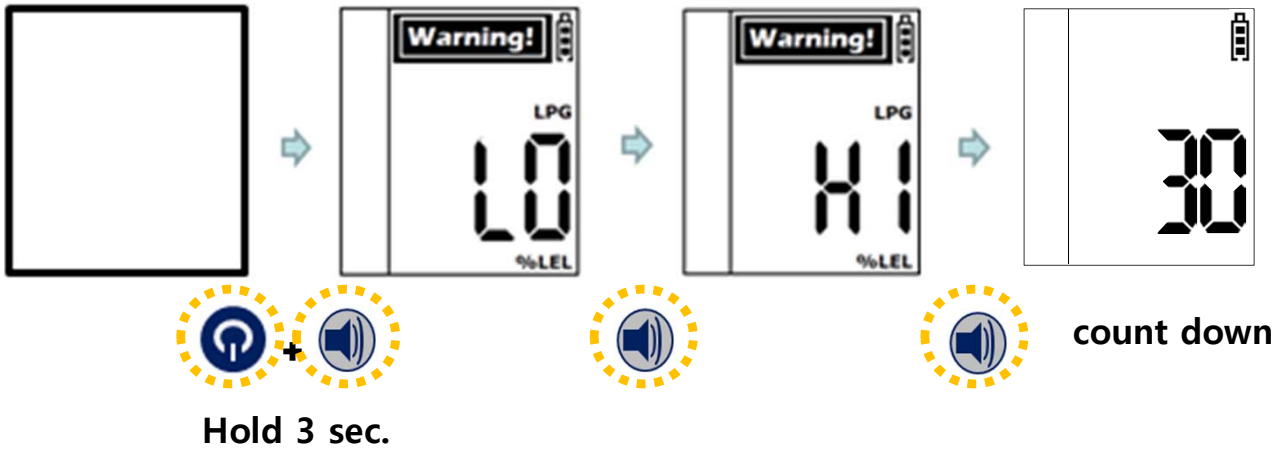

While returning to Gas Measure Mode through the 2nd alarm set up mode, countdown shall be proceeded. When countdown is completed, system shall be converted to Gas Measure Mode.

### Method of Entering Alarm Values.

After entering into alarm value set up mode, when the buzzer key is pressed, the 1st number shall blink and goes up by 1 after 1. When power key is pressed, the second number shall be blinking after moving to next position. In order to have the 3rd number blink, use arrow key to increase the number and use power key to move to the position wanted. After completing change of number to the last one, the system shall return to Alarm Value Set Up mode with alarm sound by inputting power key.

Example) Modification of the 1st alarm value of inflammable gas from 25% to 20%

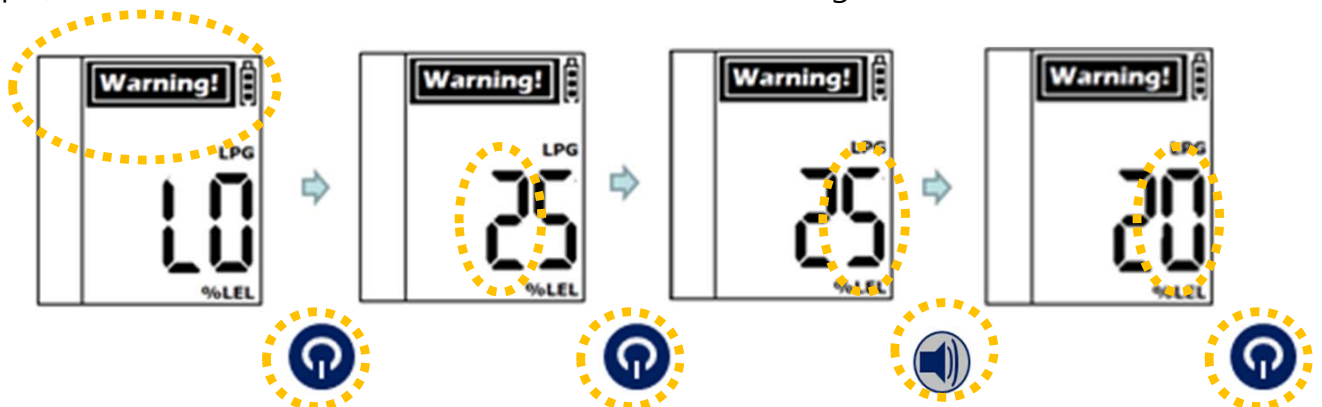

## Set Up of LPG/LNG gas

When buzzer key is pressed under the state of power Off, type of gas presently set shall be indicated. While buzzer key is pressed for 5 seconds, the set up for the type of gas shall be changed to LNG from LPG. Set up for LPG can be made in same manner as that done for LNG.

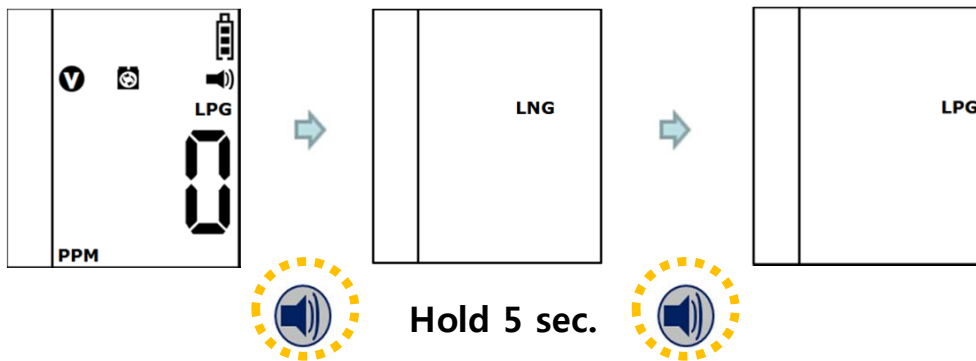

## Applicable Battery

Caution :

It is absolutely prohibited to replace battery at potential explosion areas or dangerous regions.

Specifications of the batteries applicable to this device are as follows.

- Disposable alkaline battery : Energizer No. E91, Energizer No.EN91
- Rechargeable battery : GP batteries No. GP210AAHCB

Batteries other than specified above are not allowed to use in dangerous area.

Caution : Throwing battery into fire or disassembly by force may cause explosion. Disposal of used battery should be performed in accordance with the guideline of the pertinent country or the work site.

## Adapter for Recharge

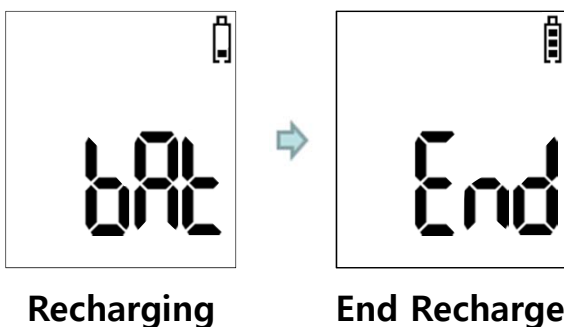

When adapter for recharge is equipped with the device, battery recharge mode shall be displayed on screen even under the mode of gas measure or power Off state. Power shall be Off when adapter is removed.

# Replacement of Battery and Sensor

Following tools and parts are necessary to replace sensor and battery of Sp Secure.

Tool : + Driver

Energizer No.E91, EN91 battery for replacement or rechargeable battery

Sensor for replacement

Sensor filter for replacement

## Caution :

No battery replacements or disassembly of product are permitted at potential explosion or dangerous area.

-Please be noted that replacement of parts may cause damage to the fundamental safety capabilities of the device..

- Sensors for replacement must be the one exclusively for SP Secure. The use of other sensors may cause problems in the detection of gas leakage or cause errors in the measurements.

- The device is to be disassembled only for the replacement of battery or sensor and it has to be calibrated by utilizing standard gas during reassembly.

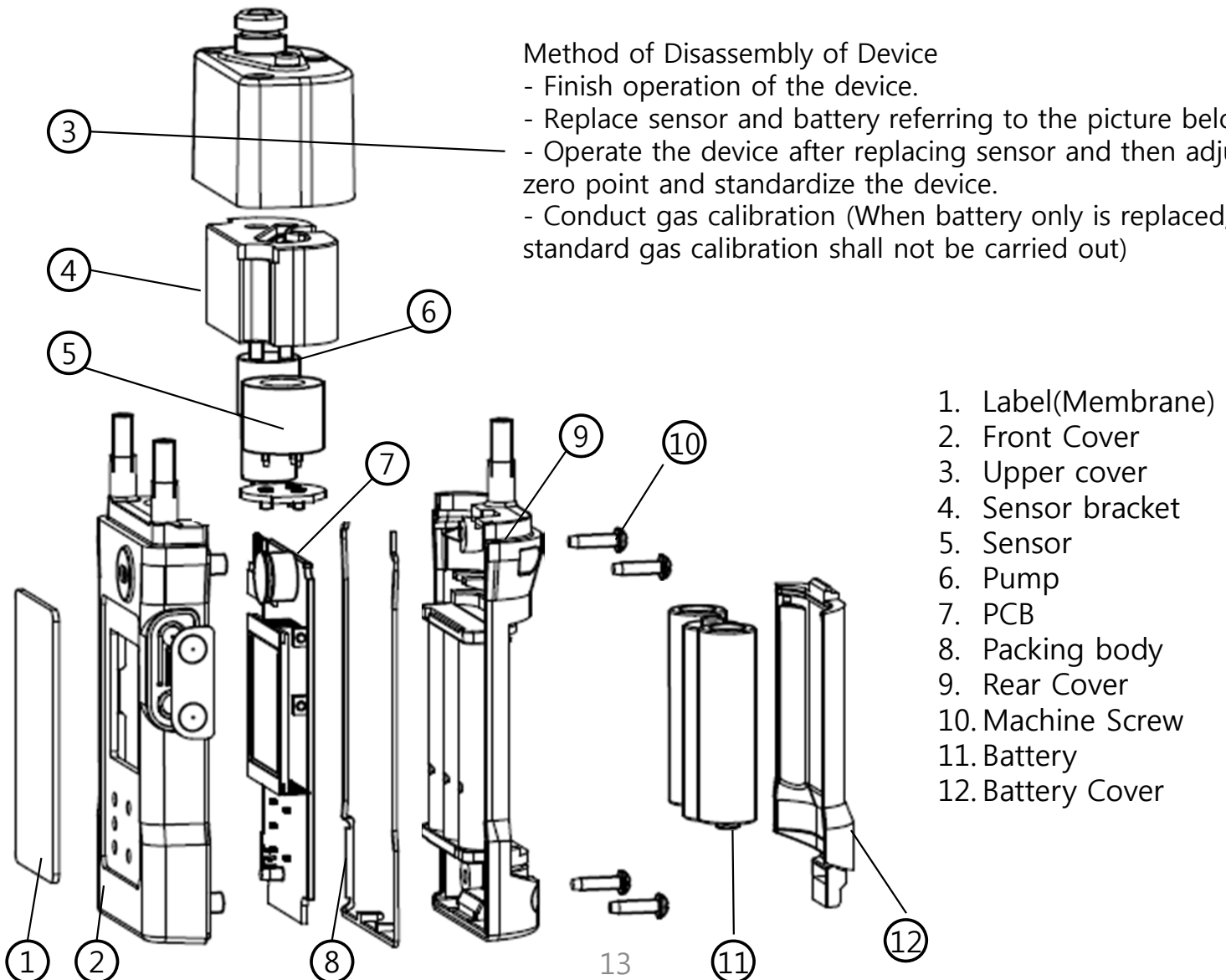

# Operation Flow Chart

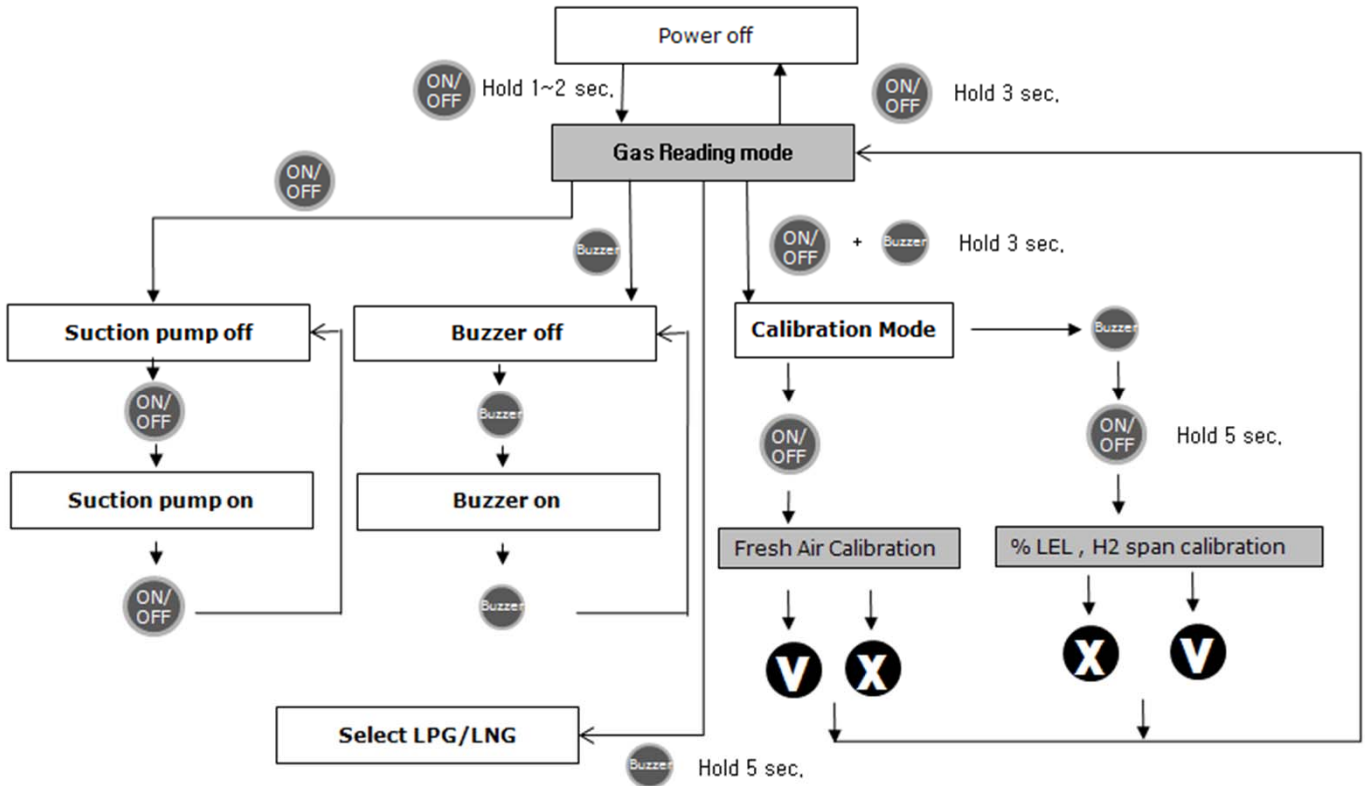

## Reading mode

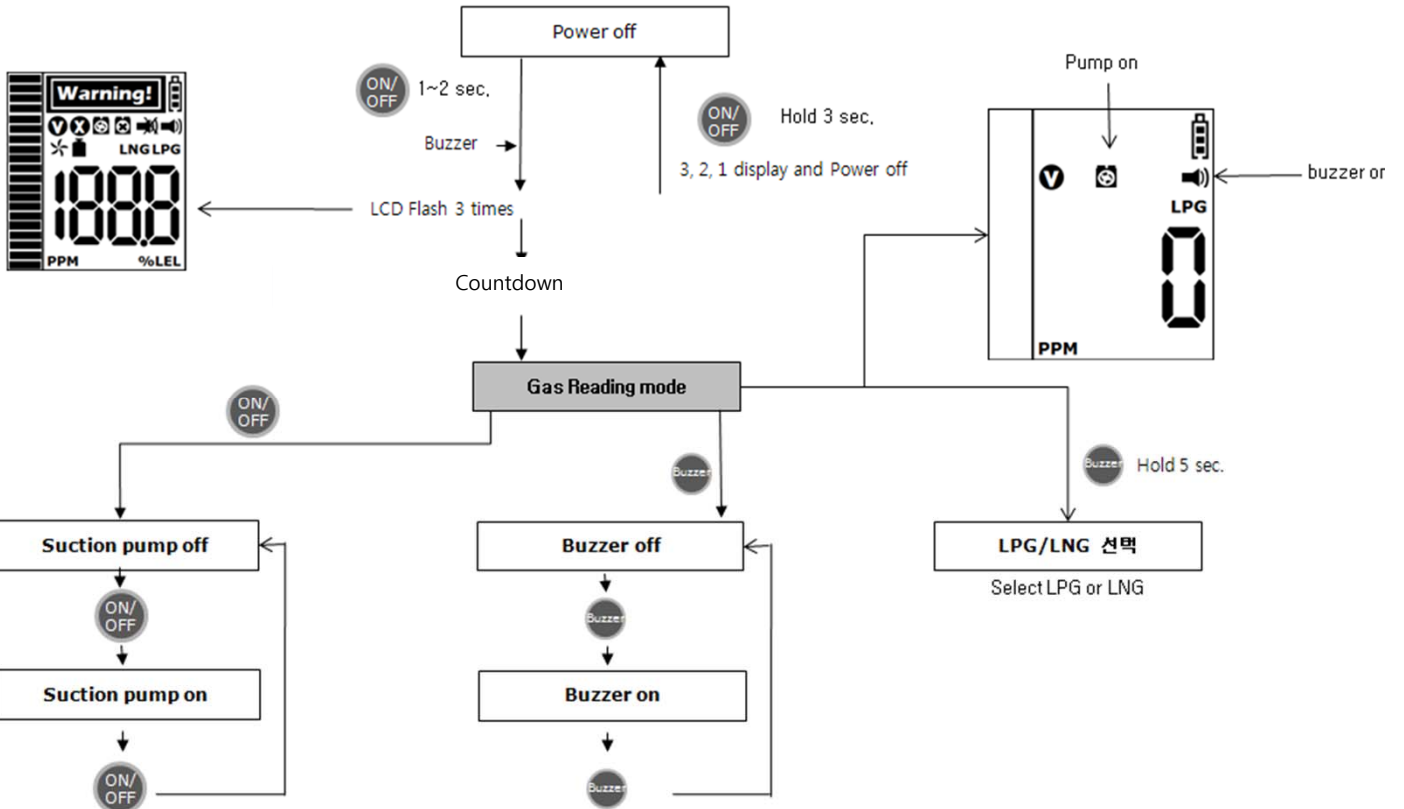

# Calibration mode

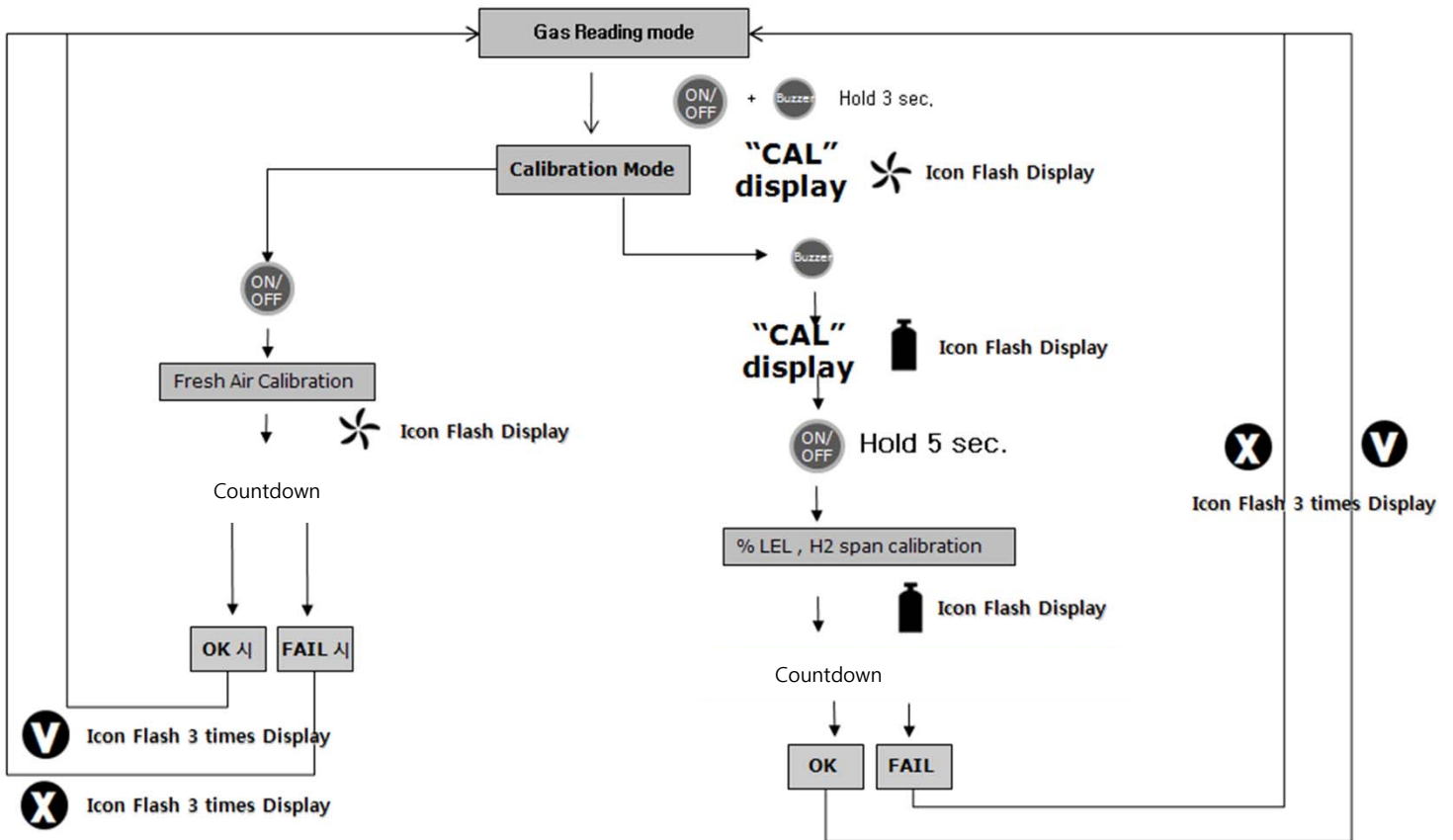

# GAS mode change & warning level setting

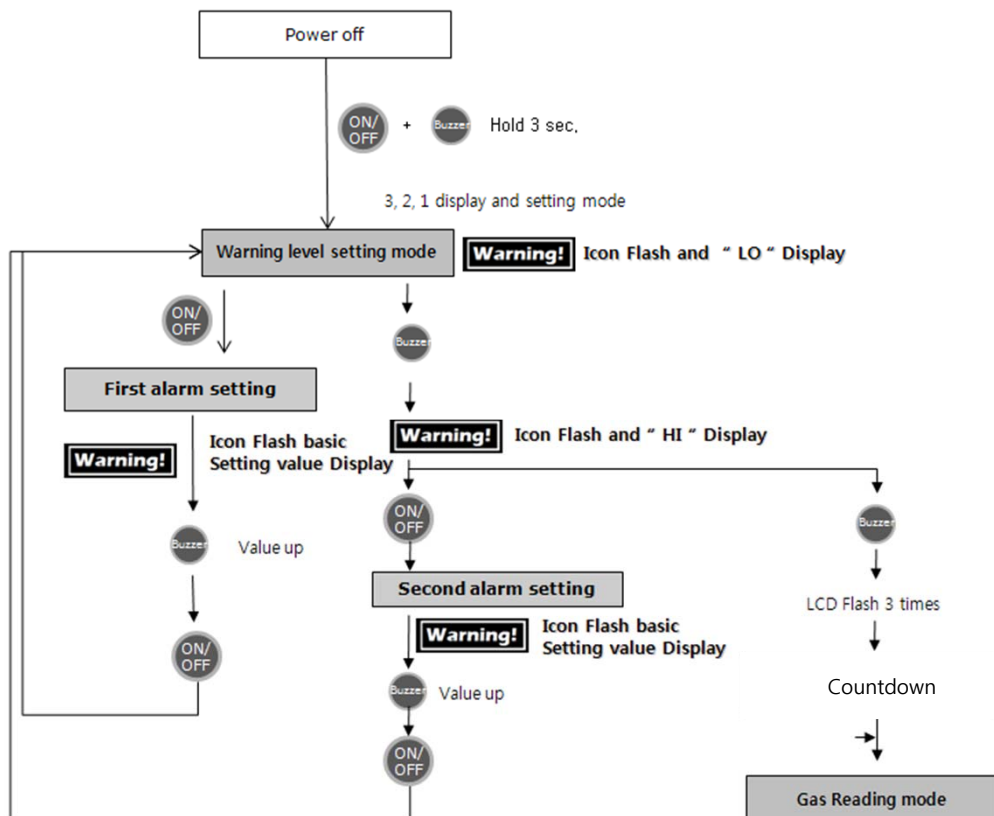



---

## Notice for User

Please use the instrument in the range of the applicable temperature, humidity and pressure that are appropriate for the specification of the product. Using the instrument beyond this range may cause malfunction or glitch of the instrument. .

Gas concentration measurement value by the sensor or the instrument can vary according to the environment at site (temperature, pressure and humidity). Therefore the calibration of the instrument should be performed at the same or similar environment as that of the instrument use (temperature, pressure and humidity),

If temperature changes sharply during use of the instrument (for instance, using the instrument at places of far different temperatures between indoor and outdoor), the value of the measured gas concentration can be changed suddenly. Please use it after the gas concentration value is stabilized. .

Severe vibration or shock to the instrument may cause the sudden change of value of the measured gas concentration. Please use it after the value of gas concentration is stabilized. Excessive shock to the unit can lead to trouble of the sensor or the instrument.

# Certificates



No. 2011-0350

## Safety Certificate

- Manufacturer **SENKO Co.,Ltd**
- Address **Rm301,Banwol hightech vilage, 768-5, Wonsi-dong, Danwon-gu, Ansan-si, Gyeonggi-do, 425-852 South Korea**

The following product produced by the above company has been authorized for the use of the Mark as the product has satisfied the safety and health standards stipulated in the article 34 of Industrial Safety and Health Law.

- Product **Portable Gas Leak Detector**
- Type(Model) **Spsecure**
- Rating **Ui=4.5V**
- Type of Protection **Ex d ia IIB T3**
- Certification No **11-GA2BO-0350X**
- Safety Certification Standards **Article 34 of Industrial Safety & Health Law**
- Certification condition **Tamb = -20°C ~ +50°C**
- Date of issue **09 Dec 2011**

Approved for issue on behalf of the president : **Young-Jin, Park**  
position : **General Manager**

Signature

A handwritten signature in black ink, appearing to read '박영진' (Park Young-jin).



**Korea Gas Safety Corporation**

# Certificates



## Certificate of New Excellent Product

This is to certify that the following designated product

*Product* Portable hydrogen leakage detector with electrochemical hydrogen gas sensor

*Company* SENKO Co., Ltd.

*President* HA SEUNG CHUL

*address* 301, Banwol Hightech Village, 768-5 Wonsi-dong, Danwon-gu, Ansan-si, Gyeonggi-do, KOREA

*Certificate number* NEP-MKE-2009-045

*Valid until* December 21, 2012

is based on newly developed technology, and is assessed as having superior quality and performance. This certification is in accordance with Article 16 of the Industrial Technology Promotion Act and Article 18 of its Enforcement Decree

March 31, 2010

*Minister*



Ministry of Knowledge Economy  
Republic of Korea