

User manual for controller/data recorder MultiCon CMC-99/141

- Firmware: **v.2.25.0** or higher

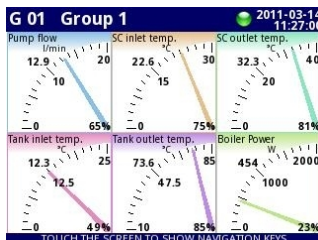
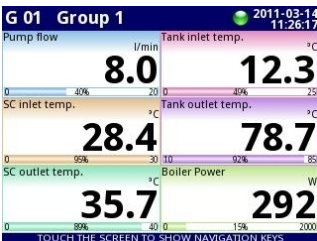

Read the user's manual carefully
before starting to use the unit or software.
Producer reserves the right to implement changes without prior notice.

CONTENTS

1. BASIC REQUIREMENTS AND USER SAFETY.....	<u>4</u>
1.1. THE USE OF TOUCH-SCREEN.....	<u>5</u>
2. GENERAL CHARACTERISTICS.....	<u>5</u>
3. TECHNICAL DATA.....	<u>8</u>
4. DEVICE INSTALLATION.....	<u>9</u>
4.1. UNPACKING.....	<u>10</u>
4.2. ASSEMBLY.....	<u>10</u>
4.3. CONNECTION METHOD.....	<u>13</u>
4.3.1. Available modules.....	<u>16</u>
4.4. MAINTENANCE.....	<u>21</u>
5. INTRODUCTION TO MULTICON CMC-99/141.....	<u>21</u>
5.1. UNDERSTANDING CONTROLLER/DATA RECORDER MULTICON CMC-99/141.....	<u>21</u>
5.1.1. Logical channels.....	<u>21</u>
5.1.2. Groups.....	<u>23</u>
5.2. HARDWARE CONFIGURATIONS.....	<u>23</u>
6. WORKING WITH THE MULTICON CMC-99/141.....	<u>24</u>
6.1. MULTICON CMC-99/141 POWER UP.....	<u>24</u>
6.2. THE USE OF THE TOUCH-SCREEN.....	<u>24</u>
6.3. DISPLAY.....	<u>25</u>
6.3.1. Information bar.....	<u>25</u>
6.3.2. Navigation bar.....	<u>26</u>
6.3.3. Data panels.....	<u>27</u>
6.3.4. Important messages.....	<u>30</u>
7. CONFIGURATION OF THE MULTICON CMC-99/141.....	<u>30</u>
7.1. EDIT DIALOGUES.....	<u>30</u>
7.2. MAIN MENU SELECTION PANEL.....	<u>34</u>
7.3. FILES MANAGEMENT.....	<u>35</u>
7.4. DEVICE INFORMATION, LICENSE AND FIRMWARE UPDATE.....	<u>40</u>
7.5. DEVICE CONFIGURATION.....	<u>41</u>
7.6. CONFIGURATION MENU STRUCTURE.....	<u>44</u>
7.7. GENERAL SETTINGS.....	<u>48</u>
7.8. LOGICAL CHANNELS.....	<u>50</u>
7.8.1. Logical Channels - general settings.....	<u>51</u>
7.8.2. Logical channels in Hardware input mode.....	<u>58</u>
7.8.3. Logical Channels in Hardware output monitor mode.....	<u>62</u>
7.8.4. Logical Channels in Modbus mode.....	<u>64</u>
7.8.5. Logical Channels settings for Set point value mode.....	<u>66</u>
7.8.6. Logical Channels settings for Math function mode.....	<u>69</u>
7.8.7. Logical Channels settings for Controller mode.....	<u>74</u>
7.8.8. Logical Channels settings for Profile/timer mode.....	<u>76</u>
7.8.9. Logical Channels for Profile/timer (cycle counter) mode.....	<u>77</u>
7.8.10. Examples of Logical Channels configuration.....	<u>77</u>
7.9. BUILT-IN OUTPUTS.....	<u>96</u>
7.9.1. Build-in outputs - general settings.....	<u>97</u>
7.9.2. Built-in Output: Relay, Sound signal, Virtual relay.....	<u>98</u>
7.9.3. Build-in output: PWM mode for SSR relay output.....	<u>102</u>
7.9.4. Build-in output - Current output.....	<u>104</u>
7.9.5. Examples of build-in output configurations.....	<u>106</u>
7.10. EXTERNAL OUTPUTS.....	<u>107</u>
7.10.1. External outputs - general settings.....	<u>107</u>
7.10.2. External outputs - Control type = as a relay.....	<u>109</u>
7.10.3. External outputs - Control type = as a linear output.....	<u>110</u>
7.10.4. Examples of external output configurations.....	<u>112</u>
7.11. PROFILES/TIMERS.....	<u>112</u>
7.11.1. Profile/timer - general settings.....	<u>113</u>

7.11.2. Profiles/timers for triggering mode: level (gate), edge (once), edge (retrig.).....	116
7.11.3. Profiles/timers for triggering mode: on time.....	118
7.11.4. Examples of Profile/timer configurations.....	120
7.12. CONTROLLERS.....	121
7.12.1. Controllers - general settings.....	121
7.12.2. Examples of Controller configurations.....	124
7.13. GROUPS.....	125
7.13.1. Groups - general settings.....	125
7.13.2. Groups - Logging options.....	128
7.13.3. Groups - Examples of visualisations of groups.....	129
7.14. MODBUS.....	131
7.14.1. Modbus - general settings.....	132
7.14.2. Modbus - SLAVE mode.....	132
7.14.2.1. Modbus SLAVE - The Modbus protocol handling.....	133
7.14.2.2. Modbus SLAVE - List of registers.....	133
7.14.2.3. Modbus SLAVE- Transmission errors handling.....	134
7.14.2.4. Modbus SLAVE- Example of query/answer frames.....	134
7.14.3. Modbus - MASTER mode.....	135
7.14.3.1. Modbus MASTER - Device templates parameter block.....	136
7.14.3.2. Modbus MASTER- Device channels parameter block.....	137
7.14.3.3. Modbus MASTER- Register blocks parameter block.....	141
7.14.4. Modbus - Register settings.....	142
7.14.5. Modbus - Example of Modbus protocol configuration in the device.....	143
7.15. NETWORK SETTINGS.....	150
7.16. ACCESS OPTIONS.....	151
8. APPENDIX - INPUT AND OUTPUT MODULES DESCRIPTION.....	152
8.1. PS3, PS4 - POWER SUPPLY MODULE.....	152
8.2. UI4, UI8, U16, I16, FI4 - VOLTAGE, CURENT AND FLOW MEASUREMENT MODULES.....	153
8.3. TC4, TC8 - THERMOCOUPLE SENSOR MEASUREMENT MODULES.....	157
8.4. RT4 - RTD MEASUREMENT MODULE.....	159
8.5. UN3 - OPTOISOLATED UNIVERSAL INPUT MODULE.....	161
8.6. D8, D16 - OPTOISOLATED DIGITAL INPUT MODULE.....	163
8.7. CP4 - OPTOISOLATED UNIVERSAL COUNTER MODULES.....	165
8.8. S8, S16 - SOLID STATE RELAY DRIVERS MODULES.....	167
8.9. R45, R81 - RELAY MODULES.....	169
8.10. IO2, IO4 - PASSIVE CURRENT OUTPUT.....	170
8.11. COMMUNICATION MODULES.....	172

Explanation of symbols used in the manual:



- This symbol denotes especially important guidelines concerning the installation and operation of the device. Not complying with the guidelines denoted by this symbol may cause an accident, damage or equipment destruction.

IF THE DEVICE IS NOT USED ACCORDING TO THE MANUAL THE USER IS RESPONSIBLE FOR POSSIBLE DAMAGES.



- This symbol denotes especially important characteristics of the unit. Read any information regarding this symbol carefully

1. BASIC REQUIREMENTS AND USER SAFETY



- **The manufacturer is not responsible for any damages caused by inappropriate installation, not maintaining the proper environmental conditions and using the unit contrary to its assignment.**
- Installation should be conducted by qualified personnel . During installation all available safety requirements should be considered. The fitter is responsible for executing the installation according to this manual, local safety and EMC regulations.
- GND input of device should be connected to PE wire;
- The unit must be properly set-up, according to the application. Incorrect configuration can cause defective operation, which can lead to unit damage or an accident.
- **If in the case of a unit malfunction there is a risk of a serious threat to the safety of people or property additional, independent systems and solutions to prevent such a threat must be used.**
- **The unit uses dangerous voltage that can cause a lethal accident. The unit must be switched off and disconnected from the power supply prior to starting installation of troubleshooting (in the case of malfunction).**
- Neighbouring and connected equipment must meet the appropriate of appropriate standards and regulations concerning safety and be equipped with adequate overvoltage and interference filters.
- **Do not attempt to disassemble, repair or modify the unit yourself. The unit has no user serviceable parts. Defective units must be disconnected and submitted for repairs at an authorized service centre.**



- In order to minimize fire or electric shock hazard, the unit must be protected against atmospheric precipitation and excessive humidity.
- Do not use the unit in areas threatened with excessive shocks, vibrations, dust, humidity, corrosive gasses and oils.
- Do not use the unit in areas where there is risk of explosions.
- Do not use the unit in areas with significant temperature variations, exposure to condensation or ice.
- Do not use the unit in areas exposed to direct sunlight.
- Make sure that the ambient temperature (e.g. inside the control box) does not exceed the recommended values. In such cases forced cooling of the unit must be considered (e.g. by using a ventilator).



The unit is designed for operation in an industrial environment and must not be used in a household environment or similar.

1.1. THE USE OF TOUCH-SCREEN

Do not use pointers with sharp edges (like tips of pencils and pens, knives, scissors, needles, wires, nails, bolts etc.) while working with touch-screen. It is strongly recommended to use a special stylus made of plastic or another soft material with round ends (for example the stylus delivered with the device). The display of the **MultiCon CMC-99/141** should also be protected against aggressive substances and extremely high and low temperatures (see **Chapter 3. TECHNICAL DATA**).

2. GENERAL CHARACTERISTICS

The **MultiCon CMC-99/141** is a sophisticated multichannel unit which allows simultaneous measurement, visualisation and control of numerous channels. This device can operate autonomously or with cooperation with external measurement devices and actuators. Essential features of **MultiCon CMC-99/141** are listed and briefly described below.

- **Advanced processing unit and system based on LINUX**

The powerful **MultiCon CMC-99/141** processor allows the device to run under the control of a LINUX operating system. Such a solution makes the firmware flexible and gives the possibility of simultaneous operation of many processes (like: measurement, communication, visualisation). The use of LINUX also makes software independent of installed hardware.

- **Colour TFT display with Touch-panel**

The **MultiCon CMC-99/141** displays all data and dialogue on a legible, 320x240 pixels, colour TFT screen. Full control of the device is realised using the built-in touch-panel which makes operating the **MultiCon CMC-99/141** easy and intuitive.

- **Hardware flexibility and a large variety of possible configurations**

MultiCon CMC-99/141 is designed as modular device consisting of a **base** and optional **input and output modules**. The **base** contains:

- main processor,
- display with touch-screen,
- Switch Mode Power Supply
 - 19V...**24**...50V DC, 16V...**24**...35V AC
 - 85V...**230**...260V,
- basic communication interfaces (USB and RS485).
- three slots (marked as A, B, C) designed for installation of measurement and/or output modules.
- one slot (marked as D) used for advanced communication module (additional USB Host, RS-485, RS-485/RS-232 and Ethernet).

All measurement and output modules are optional and can be installed inside the device according to the customer's needs.

Input modules that can be installed:

- 4/8/16x Voltage/Current input module,
- 4x RTD input module,
- 4/8x TC input module,
- 8/16x Optoisolated digital input,
- 3x universal input module,

- 4x universal counter module,
- 4x flowmeter input + 4x current input module.

Output modules that can be installed:

- 8/16x SSR driver module,
- 4x Relay module 5A/250V,
- 8x Relay module 1A/250V,
- 2/4x Passive current output module.

• **Full freedom of data sources, presentation modes and controlling methods**

The multi level structure of the **MultiCon CMC-99/141** firmware allows for selection of presented data sources, presentation modes and controlling methods. The **MultiCon CMC-99/141** displays the values of virtual **logical channels** which can be fed with:

- measurement data from built-in physical channels,
- measurement data from remote channels (other devices connected to the **MultiCon CMC-99/141** by RS-485 interface),
- output states and quantities (looped back results of controlling processes),
- generate profiles/timers or also the mathematical combination of one or more **logical channels**.

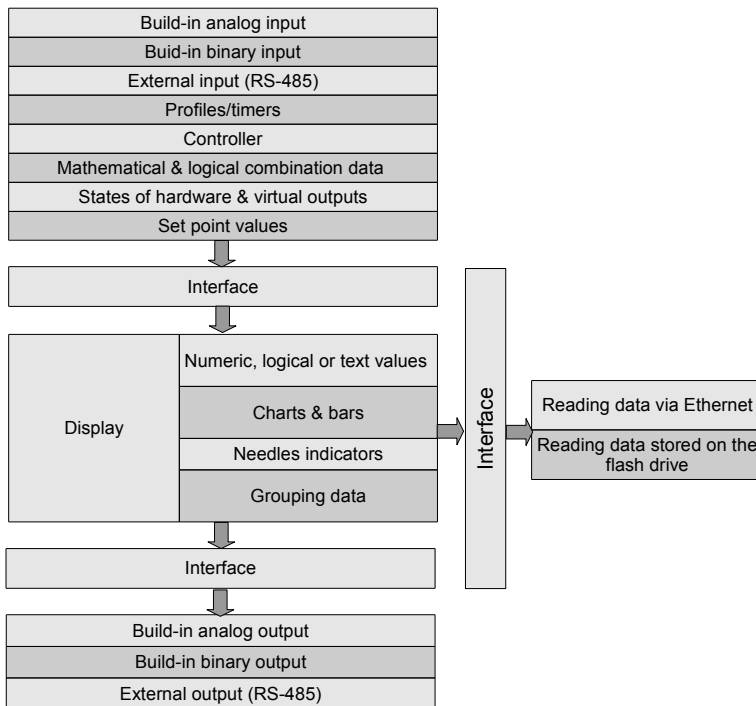

Fig. 2.1. Basic structure of the multichannel device

All of these can be freely named and described by the user, and presented in many forms:

- as numerical values,
- vertical and horizontal charts,
- vertical and horizontal bars,
- as needle graphs.

Every **logical channel** (visualised or not) can be used as input data for one or more controlling process. The **MultiCon CMC-99/141** implements many different controlling methods:

- above defined level,
- below defined level,
- inside defined range,
- outside of defined range
- PID control.

Process control with built-in outputs can be done with programmable hysteresis and delays of the outputs control. It is possible to control (linearly or bistably) remote modules. Controlling processes can drive built-in physical outputs or virtual outputs which can be used as inputs to **logical channels**.

3. TECHNICAL DATA

Power supply voltage (depending on version)	85... 230 ...260V AC/DC; 50 ÷ 60 Hz or 19... 24 ...50V DC; 16V... 24 ...35V AC
External Fuse (required)	T - type, max. 2 A
Power consumption	typically 15 VA; max. 20 VA
Display (depending on version)	3.5" or 5.7", TFT colour graphic display, 320 x 240 pixels, with LED backlight
Sensor power supply output	24V DC ± 5% / max. 200 mA,
Basic communication interfaces	RS 485, 8N1/2, Modbus RTU, 1200 bit/s ÷ 115200 bit/s USB Host port, USB Device port
Digital input	1 input 0/15..24V DC, galvanic insulation (low state: 0÷5V, high state:8÷24V) power consumption: 7,5 mA / 24V, insulation: 1min @ 500V DC.
Optional communication module*	Second USB Host port Serial RS-485 and RS-485/RS-232 Ethernet 10M RJ-45
Optional input modules*	4/8/16x Voltage (0÷10V) / Current (0÷20mA)** 4x RTD (Pt100, Pt500, Pt1000, Cu50, Cu100)** 4/8x TC (J, K, S, T, N, R, B, E, L(GOST)** 8/16x Digital input** 3x Universal input** 4x Universal counter** 4x flowmeter + 4x Current**
Optional output modules*	4x Relay 5A/250V (cos φ = 1)** 8x Relay 1A/250V (cos φ = 1)** 8/16x SSR driver (10÷15V, up to 100mA per output)** 2/4x IO Passive current output (4÷20mA)**
Protection level	
USB interface on rear panel	IP 65 (from front, after using waterproof frame) IP 54 (from front, with transparent door) IP 40 (from front, standard) IP 20 (housing and connection clips)
USB interface from front	IP 54 (from front, with transparent door) IP 40 (from front, standard) IP 20 (housing and connection clips)
Housing type	panel
Housing material	NORYL - GFN2S E1
Housing dimensions	96 x 96 x 100 mm (small housing) or 145 x 145 x 100 mm (big housing)
Mounting hole	90.5 x 90.5 mm (small housing) or 137 x 137 mm (big housing)

Assembly depth	102 mm
Panel thickness	max. 5 mm
Operating temperature	0°C to +50°C
Storage temperature	-10°C to +70°C
Humidity	5 to 90% no condensation
Altitude	up to 2000 meters above sea level
Screws tightening max. torque	0,5 Nm
Max. connection leads diameter	2,5 mm ²
Safety requirements	according to: PN-EN 61010-1 installation category: II pollution degree: 2 voltage in relation to ground: 300V AC insulation resistance: >20M Ω insulation strength between power supply and input/output terminal: 1min. @ 2300V (see Fig. 4.1)
EMC	PN-EN 61326-1
Weight	340g (only base, see Fig. 4.8)

* check the current list of measurement modules at producer's website
** see the full specification in the appendix

4. DEVICE INSTALLATION

The unit has been designed and manufactured in a way assuring a high level of user safety and resistance to interference occurring in a typical industrial environment. In order to take full advantage of these characteristics installation of the unit must be conducted correctly and according to the local regulations.



- Read the basic safety requirements on page 4 prior to starting the installation.
- Ensure that the power supply network voltage corresponds to the nominal voltage stated on the unit's identification label.
- The load must correspond to the requirements listed in the technical data.
- All installation works must be conducted with a disconnected power supply.
- Protecting the power supply connections against unauthorized persons must be taken into consideration.



This is a class A unit. In a residential or a similar area it can cause radio frequency interference. In such cases the user can be requested to use appropriate preventive measures.



Carefully check that the insulation used with the unit (Fig. 4.1) meets the expectations and if necessary use appropriate measures of over voltage protection. Additionally, insure the appropriate air and surface insulation gaps when installing.

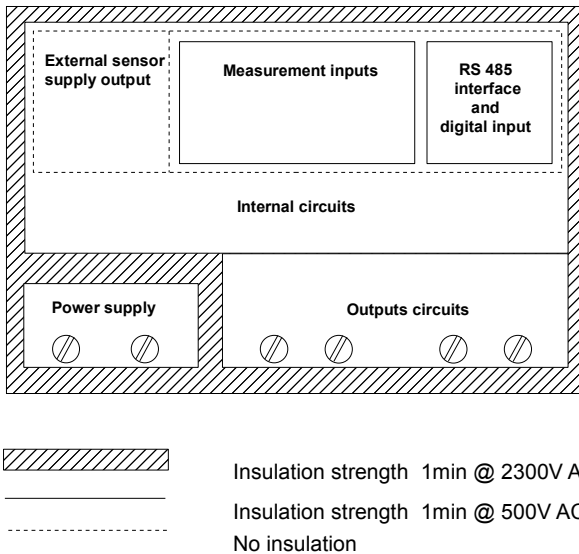

Fig. 4.1. Schematic diagram showing the insulation between individual circuits of the unit.

4.1. UNPACKING

After removing the unit from the protective packaging, check for transportation damage. Any transportation damage must be immediately reported to the carrier. Also, write down the unit serial number located on the housing and report the damage to the manufacturer.

Attached with the unit please find:

- assembly brackets - 2 pieces,
- warranty,
- user's manual for **MultiCon CMC-99/141** unit (device)

4.2. ASSEMBLY



- The unit is designed for mounting inside housings (control panel, switchboard) insuring appropriate protection against surges and interference. Metal housings must be connected to ground in a way that complies with the governing regulations.
- Disconnect the power supply prior to starting assembly.
- Check the connections are wired correctly prior to switching the unit on.

In order to install the unit, a mounting hole must be prepared according to Fig. 4.2. The thickness of the material of which the panel is made must not exceed 5mm. When preparing the mounting hole take the grooves for catches located on both sides of the housing into consideration (Fig. 4.2). Place the unit in the mounting hole inserting it from the front side of the panel, and then fix it using the brackets

(Fig. 4.4). The minimum distances between the center points of multiple units - due to the thermal and mechanical conditions of operation - are shown on Fig. 4.3.

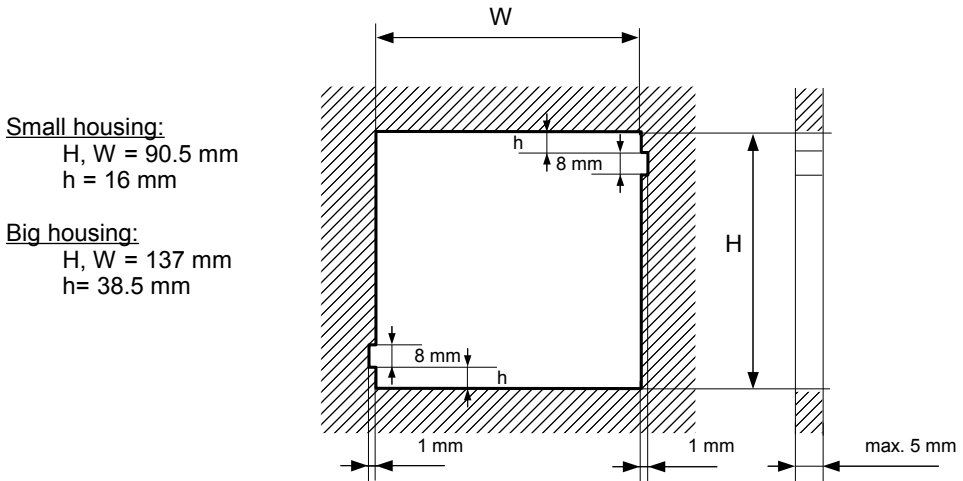

Fig. 4.2. Mounting hole dimensions

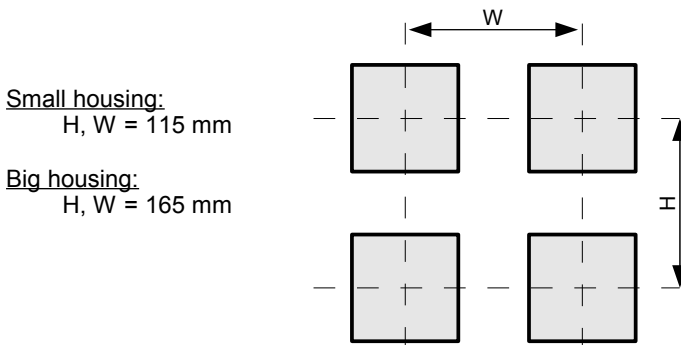

Fig. 4.3. Minimum distances when assembly of a number of units

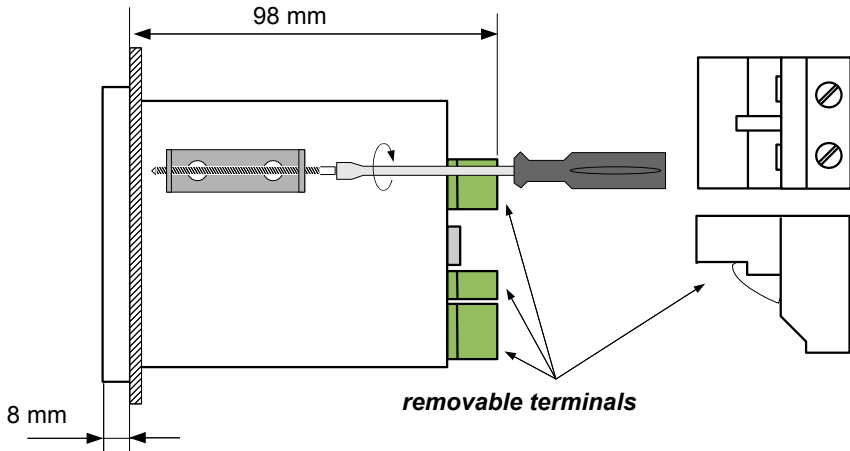

Fig. 4.4. Installing of brackets

To avoid connectors slots destruction use the method shown on Fig. 4.5

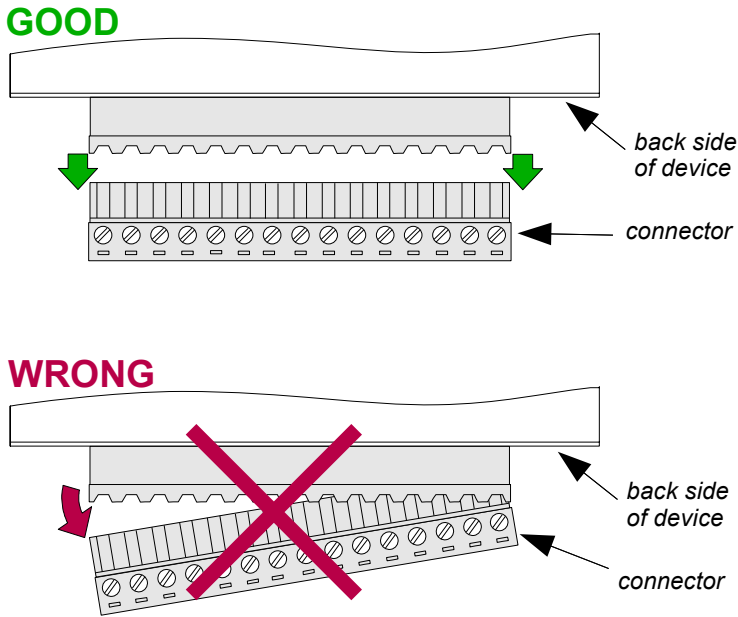

Fig. 4.5. Connectors removing method

4.3. CONNECTION METHOD

Caution



- Installation should be conducted by qualified personnel. During installation all available safety requirements should be considered. The fitter is responsible for executing the installation according to this manual, local safety and EMC regulations.
- The unit is not equipped with an internal fuse or power supply circuit breaker. Because of this an external time-delay cut-out fuse with a small nominal current value must be used (recommended bipolar, max. 2A) and a power supply circuit-breaker located near the unit. In the case of using a monopolar fuse it must be mounted on the active wire (L).
- The power supply network cable diameter must be selected in such a way that in the case of a short circuit of the cable from the side of the unit the cable shall be protected against destruction with an electrical installation fuse.
- Wiring must meet appropriate standards and local regulations and laws.
- In order to secure against accidental short circuit the connection cables must be terminated with appropriate insulated cable tips.
- Tighten the clamping screws. The recommended tightening torque is 0.5 Nm. Loose screws can cause fire or defective operation. Over tightening can lead to damaging the connections inside the units and breaking the thread.
- In the case of the unit being fitted with separable clamps they should be inserted into appropriate connectors in the unit, even if they are not used for any connections.
- **Unused terminals (marked as n.c.) must not be used for connecting any connecting cables (e.g. as bridges), because this can cause damage to the equipment or electric shock.**
- If the unit is equipped with housing, covers and sealing to protecting against water intrusion, pay special attention to their correct tightening or clamping. In the case of any doubt consider using additional preventive measures (covers, roofing, seals, etc.). Carelessly executed assembly can increase the risk of electric shock.
- After the installation is completed do not touch the unit's connections when it is switched on, because it carries the risk of electrical shock.

Due to possible significant interference in industrial installations appropriate measures assuring correct operation of the unit must be applied. To avoid the unit of improper indications keep recommendations listed below.

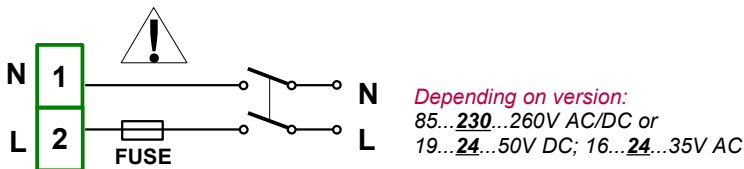

Fig. 4.6. Connection of power supply

- Avoid running signal cables and transmission cables together with power supply cables and cables controlling inductive loads (e.g. contactors). Such cables should cross at a right angle.
- Contactor coils and inductive loads should be equipped with interference protection systems, e.g. RC-type.
- Use of screened signal cables is recommended. Signal cable screens should be connected to the earthing only at one of the ends of the screened cable.
- In the case of magnetically induced interference the use of twisted pair signal cables is recommended. Twisted pair (best if shielded) must be used with RS-485 serial transmission connections.
- In the case of measurement or control signals are longer than 30m or go outside of the building then additional safety circuits are required.
- In the case of interference from the power supply side the use of appropriate interference filters is recommended. Bear in mind that the connection between the filter and the unit should be as short as possible and the metal housing of the filter must be connected to the earth with the largest possible surface. The cables connected to the filter output must not be run with cables with interference (e.g. circuits controlling relays or contactors).

Connections of power supply voltage and measurement signals are executed using the screw connections on the back of the unit's housing.

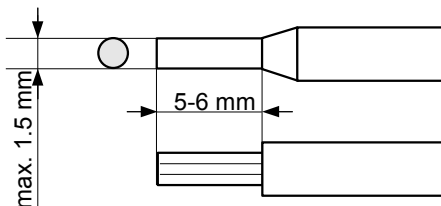

Fig. 4.7. Method of cable insulation replacing and cable terminals dimensions



All connections must be made while power supply is disconnected !

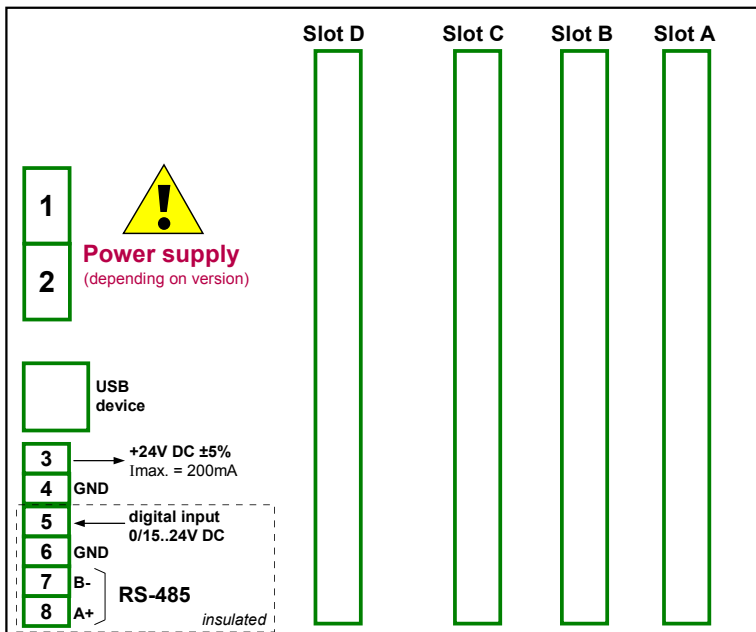

Fig. 4.8. Terminals description

The basic performance of the device (see Fig. 4.8) contains only the extreme left terminals:

- Power supply,
- USB device port,
- Sensor supply output +24V DC I_{max}=200mA,
- Digital input 0V...15...24V DC (low state: 0÷5V, high state:8÷24V)
- Interface RS-485,



In case of **UN3** module installed , there is **no +24V DC output** and this terminal stay not connected. This limitation is temporary and will be removed soon.

Depending on customer's needs, the basic version of the device can be upgraded with up to:

- three I / O modules (installed in a place designated as Slot A, Slot B Slot C),
- advanced communication module (additional serial, USB and Ethernet interfaces).

According to the order these terminals can look different than shown in Fig. 4.8 or be not present. Terminals and connections of available modules are shown on Fig. 4.9-4.14.

Shown below is an example of a configuration of the installed modules:

- base,
- Slot A - UI8 module (8 current input & 8 voltage input),
- Slot B - RT4 module (4 RTD input),
- Slot C - R81 module (8 relay output 1A/250V),
- Slot D - ACM module (additional serial, USB and Ethernet interfaces).

4.3.1. Available modules

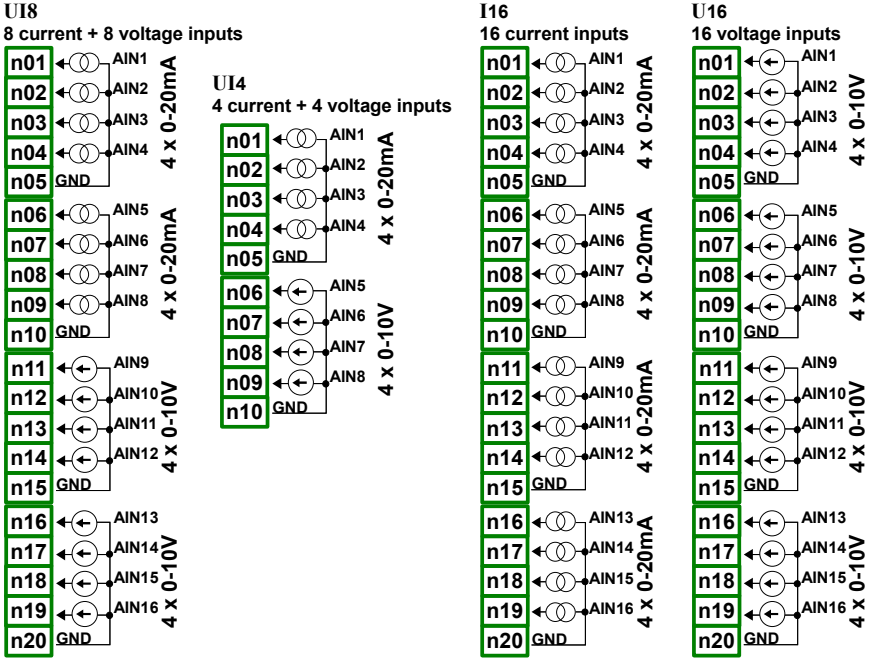

Fig. 4.9. Available current and voltage input modules

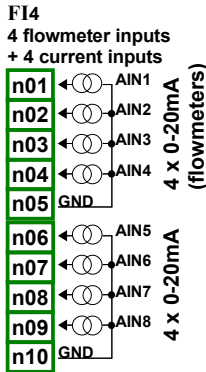

Fig. 4.10. Available flowmeter modules

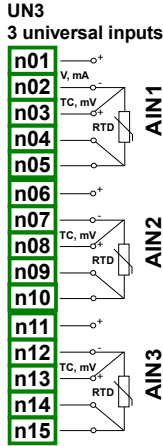

Fig. 4.11. Available universal input modules

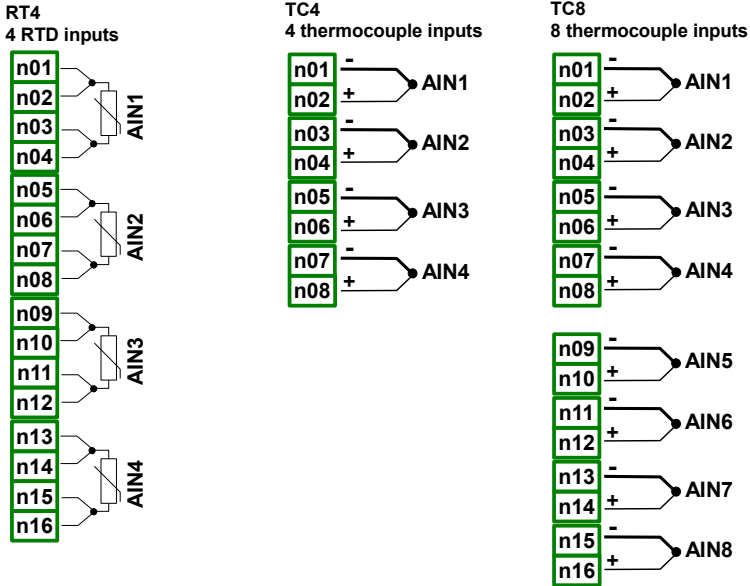

Fig. 4.12. Available RTD and TC input modules

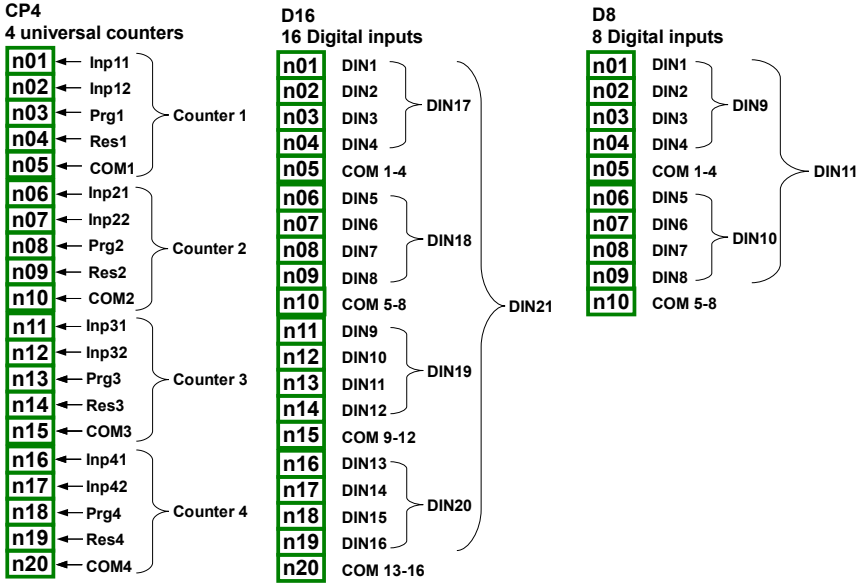

Fig. 4.13. Available Counters and Digital input modules

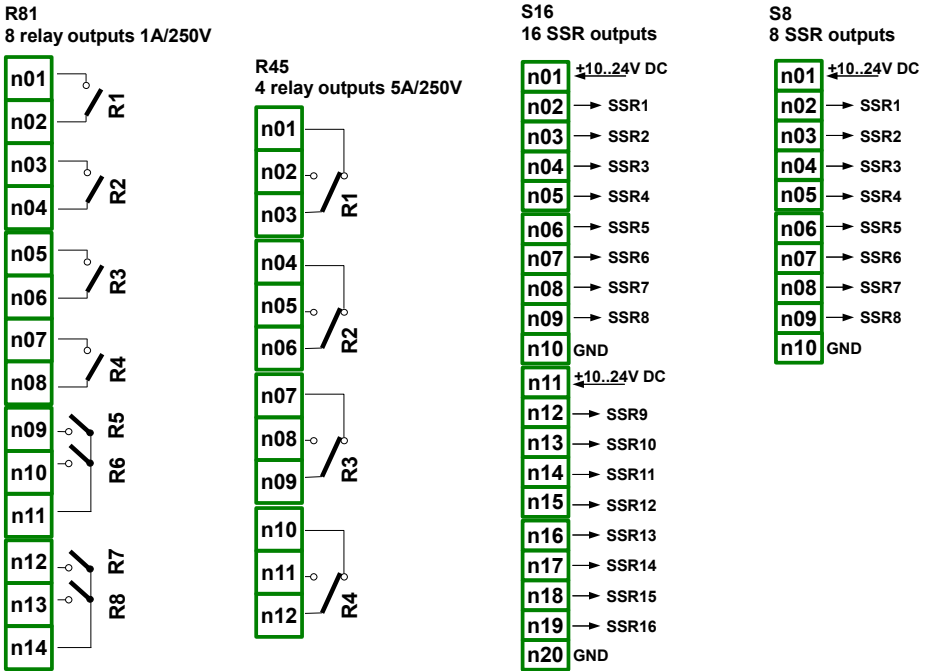

Fig. 4.14. Available output modules

IO4
4 current output

IO2
2 current output

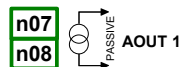
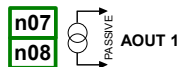
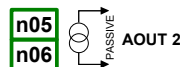
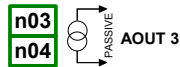

Fig. 4.15. Available passive current output

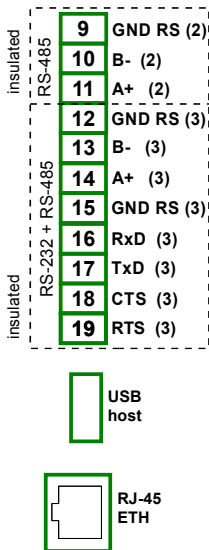

Fig. 4.16. ACM communication module

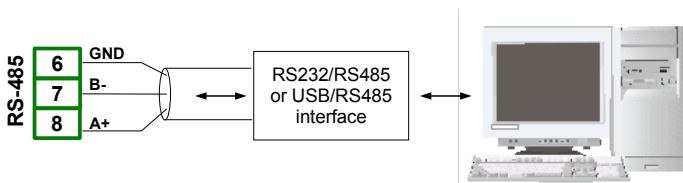

Fig. 4.17. Connection of RS-485 transmission signals

The **MultiCon CMC-99/141** device supports the following converters:

- USB / RS-485 converter (**SRS-USB/4-Z45**)
- RS-232 / RS-485 converter (**SRS-2/4-Z45**)

4.4. MAINTENANCE

The unit does not have any internal replaceable or adjustable components available to the user. Pay attention to the ambient temperature in the room where the unit is operating. Excessively high temperatures cause faster ageing of the internal components and shorten the fault-free time of the unit's operation.

In cases where the unit gets dirty do not clean with solvents. For cleaning use warm water with small amount of detergent or in the case of more significant contamination ethyl or isopropyl alcohol.



Using any other agents can cause permanent damage to the housing.



Product marked with this symbol should not be placed in municipal waste. Please check local regulations for disposal of electronic products.

5. INTRODUCTION TO MultiCon CMC-99/141

5.1. UNDERSTANDING CONTROLLER/DATA RECORDER MultiCon CMC-99/141

The **MultiCon CMC-99/141** device was developed as a universal multichannel controller. To maintain this concept its firmware was written with multi level structure. The device runs under the control of a LINUX operating system keeping all subsystems ready to use and allowing independent and simultaneous operation of many processes (communication, data acquisition, post-processing, visualisation etc.). Such an approach gives great advantages to high level applications, making it flexible and dynamically configurable. Similarly data structures and streams were implemented in quite a different way than in most similar devices. The main difference is the concept of using **Logical Channels** as a bridge: physical inputs and outputs - visualisation and controlling processes. Designers of **MultiCon CMC-99/141** decided to use such solution to increase functionality of the device and make software near fully independent on the hardware.

5.1.1. Logical channels

A **Logical Channel** is a data stream existing in the memory of the device, having it's own name and can be displayed in almost any way. **Logical Channels** can be used as:

- measurement inputs,
- data source of control loop,
- control source of the physical outputs,
- input data to other **Logical Channels**,
- data source for visualisation and logging.

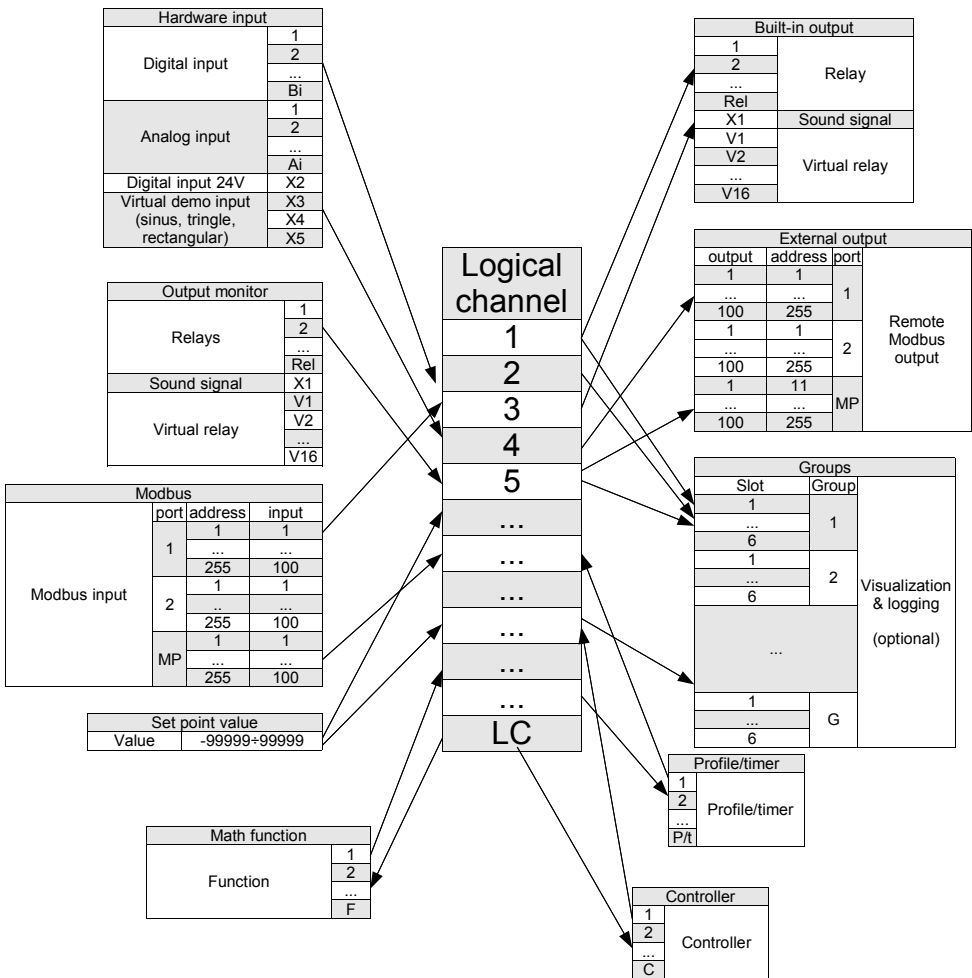

Fig. 5.1. The overall connections structure of the Logical channel with the device I/O

Fig. 5.1 shows general structure of connections between logical channels, and device inputs/outputs. Each **Logical Channels** can be configured to represent:

- measurement data from built-in physical input channels,
- output data and states of physical output channels,
- output data and states of external modules connected to **MultiCon CMC-99/141** via RS-485 interface,
- states and data coming from outputs of controlling processes,
- generated profile/timer
- states of virtual input channels, and timers,
- mathematical combination of other **Logical Channels**.

More information about Logical channels and samples of configuration Logical channels are presented in **Chapter 7.8 LOGICAL CHANNELS**.

To make visualization clearer **Logical Channels** can be gather into **Groups**.

5.1.2. Groups

A **Group** is a set of 1-6 **Logical Channels**. The **MultiCon CMC-99/141** can show on the same screen only channels belonging to the same **Group**, additionally each **Group** has its own individual name making operation with the device very clear. Every **Logical Channel** can belong to one or more groups simultaneously, and also not to belong to any group (then it will not be shown, but it can still be used for other processes). It is common that channels belonging to the same **Group** are related to one another in some way (for example representing parameters of single object or representing similar parameters of few separate objects) but it is also possible to create a **Group** consisting of completely unrelated channels.

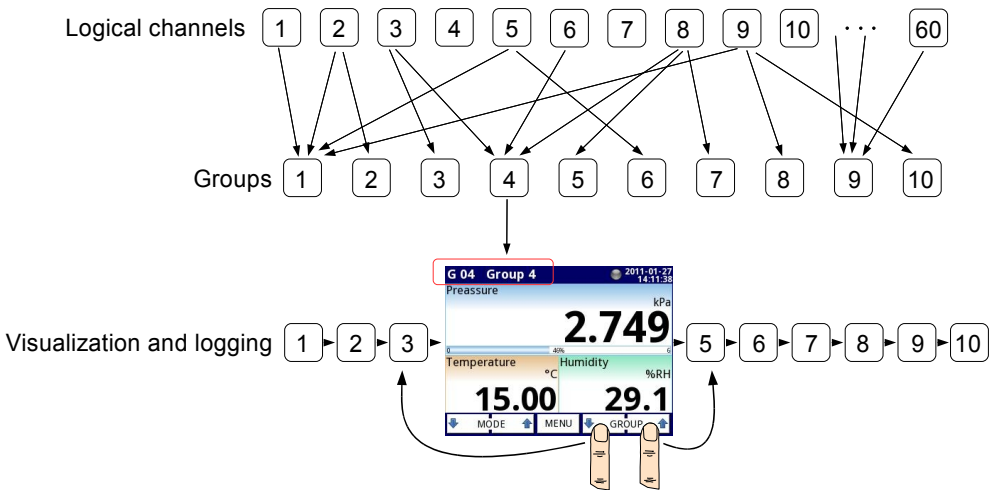

Fig. 5.2. An overview of the concept of Group in the device

Using **Groups**, **Logical Channels** and mathematical combinations of them gives incredible flexibility to the software, allowing for ease in designing advanced control methods and visualisation with a low cost **MultiCon CMC-99/141**.

More information about Groups and samples of Group configurations are presented in **Chapter 7.13 GROUPS**.

5.2. HARDWARE CONFIGURATIONS

The functionality of **MultiCon CMC-99/141** can fit to the user's needs. The **base** of the **MultiCon CMC-99/141** contains: the main processor, display with touch-screen, Switch Mode Power Supply (in one of two versions: 19V...24...50V DC 16V...24...35V AC and 85V..230..260V AC) and basic communication interfaces like USB and RS485. See Fig. 4.8 - most far left connectors. All other modules are optional and can be installed inside the device according to

customer's needs. Next to the basic connectors is the slot for an advanced communication module. In the simplest version this module can be equipped only with rear USB Host connector (this is standard for the IP-65 version of the **MultiCon CMC-99/141**). The full version of this module contains also 2 additional serial ports (RS485 and RS485/RS232) and a 10Mb Ethernet RJ-45 connector (see Fig. 4.16).

Three slots designed for built-in hardware inputs and outputs are installed on the right side of the case (see Fig. 4.8, terminals marked: slot A, slot B and slot C). The number and size of these terminals varies depending on module type. Brief descriptions of available modules are shown in Fig. 4.9-4.16. Measurement and actuator modules are constantly being developed, so the current list of available modules varies (visit manufacturers website to check current list of **MultiCon CMC-99/141** modules).

Basic measurement modules are:

- 4/8/16x Voltage/Current input module,
- 4x RTD input module,
- 4/8x TC input module.

Output modules are:

- 8/16x SSR driver module,
- 8x Relay 1A/250V module,
- 4x Relay 5A/250V module,
- 2/4x IO passive current output.

Communication module:

- ACM - advanced communication module.

6. WORKING WITH THE MultiCon CMC-99/141

6.1. MultiCon CMC-99/141 POWER UP

After powering up a starting Logo is showed on the **MultiCon CMC-99/141** display. While the operating system is being loaded a progress bar is visible in the middle of the screen. During this process the view of screen may stay dimmed for 3-5 seconds. Please wait until the end of this operation before starting to operate the device. After that the main application is started. The view of the main program depends of the **General settings** (see the **Chapter 7.8.1 Logical Channels - general settings**) and **Group** settings (see **Chapter 7.13 GROUPS**). An example view of the main program shown in Fig. 6.1.

6.2. THE USE OF THE TOUCH-SCREEN

Do not use pointers with sharp edges (like tips of pencils and pens, knives, scissors, needles, wires, nails, bolts etc.) while working with touch-screen. It is strongly recommended to use a special stylus made of plastic or another soft material with round ends (for example the stylus delivered with the device) or a finger. The display of the **MultiCon CMC-99/141** should also be protected against aggressive substances and extremely high and low temperature(see technical data in **Chapter 3 TECHNICAL DATA**).



To clean the LCD screen you should use a special detergent designed for LCDs and a soft cloth.

6.3. DISPLAY

The **MultiCon CMC-99/141** displays all data and dialogue on a 3,5" 320x240 pixel, colour TFT screen with embedded touch screen panel. New devices have the display protected with a thin transparent plastic cover. This protective layer should be removed before use to ensure perfect visibility of pictures and sensitivity of the touch-screen.

While normal operation the **MultiCon CMC-99/141** displays data in a form selected by user, at any time it is possible to switch presentation mode and group or show configuration menu. All details of the user interface are designed to make use of device easy and intuitive. To change display mode, group or to enter the menu, touch the screen of the **MultiCon CMC-99/141** and press appropriate button in the **Navigation bar**.



Further information about menu and presentation modes are described in further chapters.

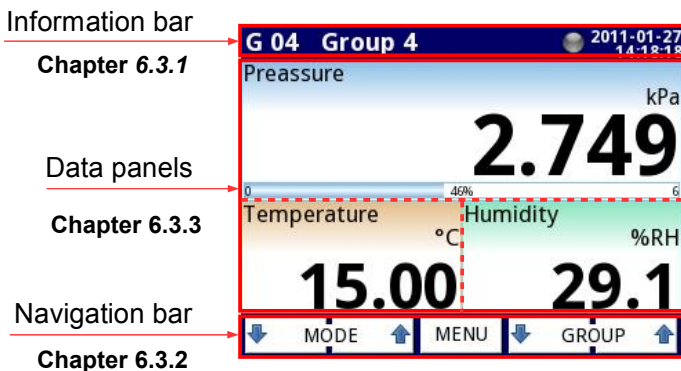

Fig. 6.1. Typical view of a **MultiCon CMC-99/141** main page, after touching display

6.3.1. Information bar

The **Information bar** informs the user about current, display group, logging, actual date and time.

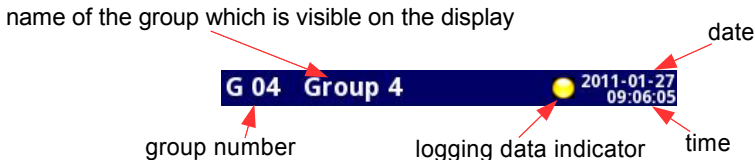

Fig. 6.2. View of information bar

Information bar displays (Fig. 6.2):

- **name of the Group** visible on the screen, in place of standard name (e.g. **Group 4**). It is possible to enter a more descriptive name for clarity (for more information see **Chapter 7.13. GROUPS**),
- **group number** - number of the currently displayed Group, to change the displayed **Group** press button [**↓GROUP**] or [**GROUP↑**] in the **Navigation bar** (see **Chapter 6.3.2 Navigation bar**),
- **time and date** - actual time and date display on the right upper corner on the screen can be set in **General settings** (see **Chapter 7.7. GENERAL SETTINGS**),
- **logging data indicator** - located in the **Information bar** the **logging data indicator** changes color depending of state logging:
 - **gray color** - data logging option is not activated (to activate data logging option you need to enter the licence key provided by manufacturer - see **Chapter 7.4. DEVICE INFORMATION, LICENSE AND FIRMWARE UPDATE**),
 - **green color** - after activation the data logging option indicator changes to green both when the data logging is enabled and when it is disabled (for more information about setting data logging see **Chapter 7.13.2. Groups - Logging options**),
 - **yellow color** - possibility to logging data in the device with additional information that there is only **10MB** of free memory remaining (to clear the memory you need to move onto a removable flash drive any important data logging files and possibly the Modbus templates, after which remove them from the device - more information see **Chapter 7.3. FILES MANAGEMENT**),
 - **red color** - warning about the lack of space on memory card, meaning data logging would not be possible until space is freed in the memory (how to remove data and exchange data with a flash drive is shown in **Chapter 7.3. FILES MANAGEMENT**)
 - **alternately blinking green with a blue color** - when the indicator flashes blue the logged data is moved to memory (Note! at this time you must not turn off the device because it may cause a loss of recently logging data).



In order to turn off the device especially when the data logging is **ON** it is recommended to use the safe-off device by pressing the button **Safe-shutdown** in the main menu (see Fig. 7.14).

6.3.2. Navigation bar

The touching the screen at any place causes the **Navigation bar** to display (see Fig. 6.3) which allows the user to switch between visualisation modes, groups and to enter the menu.

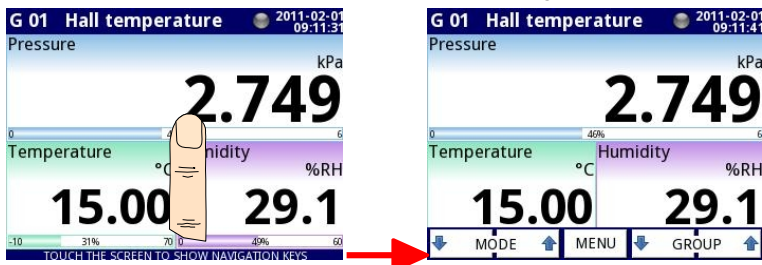
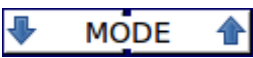
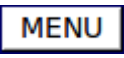
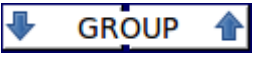

Fig. 6.3. Main window of device – displaying the **Navigation bar**

This bar contains three kinds of buttons:

	switching between visualisation modes of current group (for possible modes see Chapter 6.3.3. Data panels and Chapter 7.13. GROUPS)
	entering the main menu (see details in Chapter 7. CONFIGURATION OF THE MultiCon CMC-99/141)
	switching between presented groups of logical channels (activation and settings for Group view see Chapter 7.13 GROUPS)



To enter directly into the configuration menu of particular **Logical channel**, press and hold screen over the channel data panel for 3-4 seconds (see option **(1)** in the Fig. 6.4 entering configuration of the **logical channel** named 'Temperature'). Similarly to go directly to configuration of displayed **Group**, touch and hold the **group number** or **group name** in the upper **Information bar** for a few seconds (see option **(2)** in the Fig. 6.4 entering configuration of the **Group** named 'Group 4'). In both cases if a password is set (see **Chapter 7.16. ACCESS OPTIONS**) then the user has to enter the password before entering the configuration.

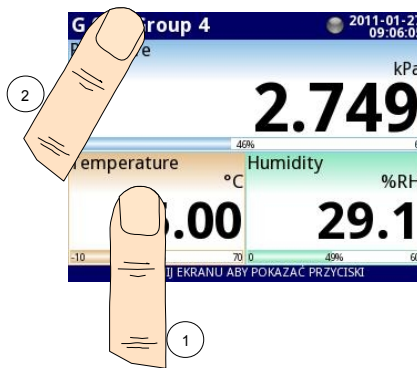

Fig. 6.4. Methods for direct entry to **Logical channel** configuration **(1)** and **Group** configuration **(2)**

6.3.3. Data panels

The great deal of the screen is being used for channel visualisation. Data can be presented in one of the following modes:

- as numerical values,
- as charts,
- as bars,
- as needle dials.

All channels of the current group are simultaneously presented in the same mode. In the current version of software there is no possibility to mix different modes in one view. Figures 6.6 – 6.10 show examples of different views. The switching between visualisation modes can be done by pressing the buttons **[MODE↑]** or **[MODE↓]** in the **Navigation bar** (see **Chapter**

6.3.2. Navigation bar). Switching between groups can be done by pressing the buttons [GROUP↑] or [GROUP↓].



Fig. 6.5. View of the **Data panel**

In all data panels (a sample of a data panel is shown inside the frame marked (1) in Fig. 6.5) the following information is available:

- value of the logical channel (denoted by (2) in Fig. 6.5),
- data unit (denoted by (3)),
- channel's name (denoted by (4)),
- on some modes there is also a visible percentage indicator of the value in relation to it's full scale (denoted by (5)),

Every **Group of Logical Channels** can be presented in one of 6 modes:

- as numerical values Fig. 6.6
- as horizontal bars Fig. 6.7
- as vertical bars Fig. 6.7
- as horizontal charts Fig. 6.8
- as vertical charts Fig. 6.8
- as needle dials Fig. 6.9

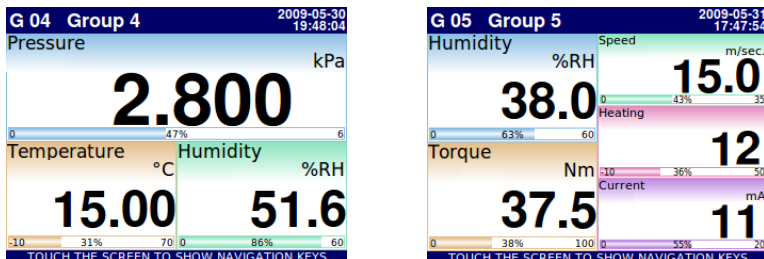

Fig. 6.6. Examples of **Numerical Values** presentation mode

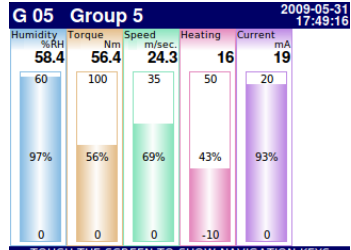
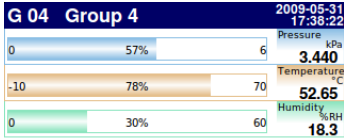

Fig. 6.7. Examples of **Horizontal** (for 3 channels) and **Vertical Bars** (for 5 channels)

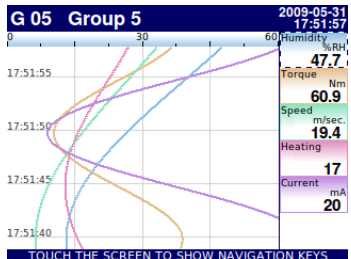
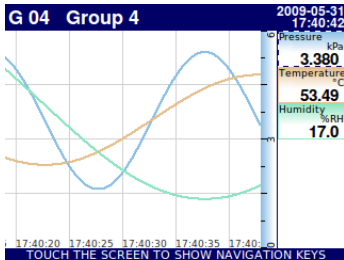

Fig. 6.8. Examples of **Horizontal** (for 3 channels) and **Vertical Charts** (for 5 channels)

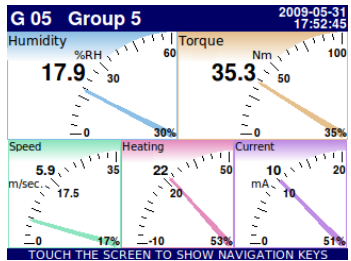
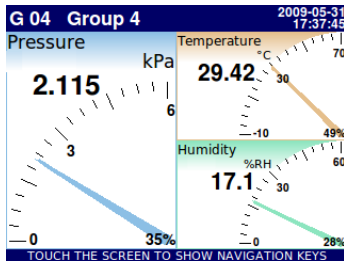
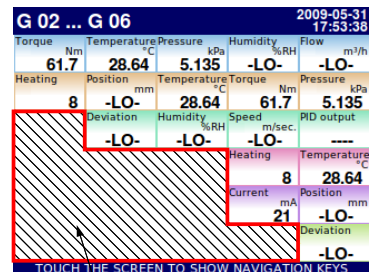
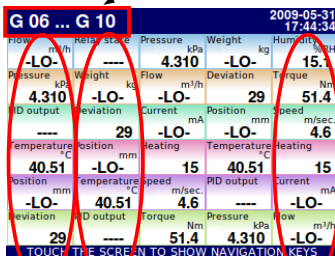

Fig. 6.9. Examples of **Needle Dials** for 3 channels and for 5 channels



Group 6 7 ... 10

Inactive logical channels in the groups

Fig. 6.10. Examples of simultaneous presentation of **Many Groups**

There is also the possibility to show many groups on a single screen (Fig. 6.10). In this mode channels belonging to the same group are displayed under one another, and groups are placed side by side. As much as 5 groups can be displayed simultaneously on a single screen (for example, groups starting from group 8 will display on the screen, starting from the left side of the page, groups: 8, 9, 10, 1, 2),

See **Chapter 7.13 GROUPS** for more information about **Groups**.

6.3.4. Important messages

The user will sometimes be asked, informed and alerted about a variety of events by messages displayed on the screen. Figures show below (Fig. 6.11÷Fig. 6.14) present examples of these messages.

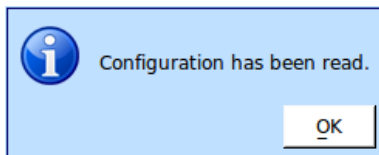

Fig. 6.11. Information message

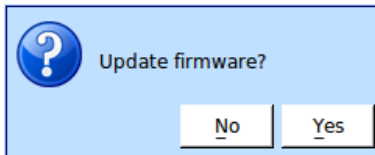

Fig. 6.12. Question message

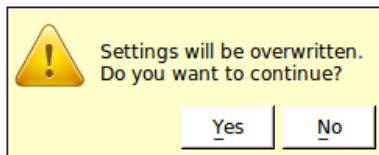

Fig. 6.13. Warning message

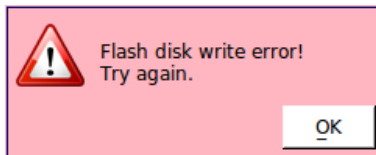

Fig. 6.14. Alert message

7. CONFIGURATION OF THE MultiCon CMC-99/141

7.1. EDIT DIALOGUES

Configuration process are based on edit dialogues. Some of the dialogues are common to different menus, such dialogues are:

- text editor, which is divided into tabs:
 - letters, see Fig. 7.1,
 - numbers and arithmetic signs, see Fig. 7.2,
 - the special symbols, see Fig. 7.3,
 - diacritical letters, Fig. 7.4,
 - font and background colours, see Fig. 7.5,
- values editor, which is divided into tabs:
 - decimal form, see Fig. 7.6,
 - hexadecimal form, see Fig. 7.7,
 - binary form, see Fig. 7.8,

- switch editor, which is divided:
 - single choice type options, see Fig. 7.9,
 - multiple choice type options, see Fig. 7.10,
- file editor, which is divided:
 - single file selection, see Fig. 7.11,
 - multiple files selection, see Fig. 7.11,

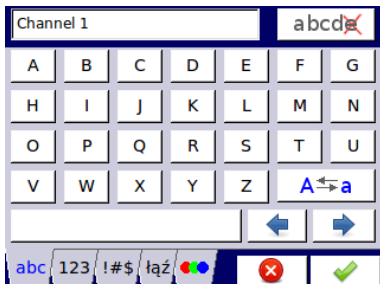

Fig. 7.1. Text editor – letters

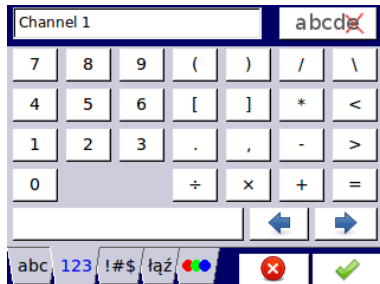

Fig. 7.2. Text editor – numbers

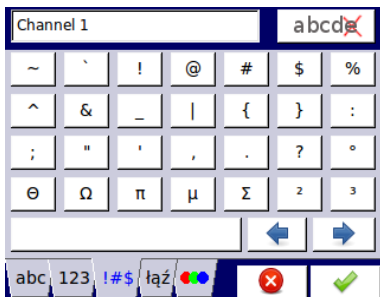

Fig. 7.3. Text editor – special symbols

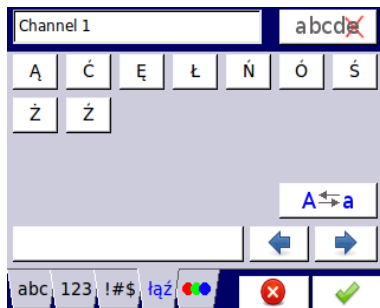

Fig. 7.4. Text editor – diacritical letters

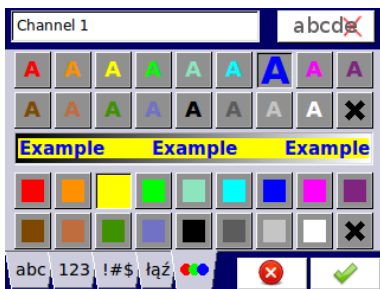

Fig. 7.5. Text editor – font and background colour selection

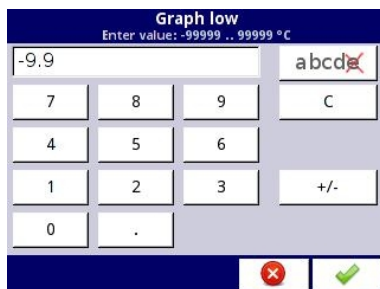

Fig. 7.6. Value editor – decimal form

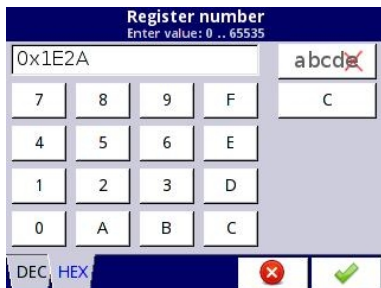

Fig. 7.7. Value editor – hexadecimal form

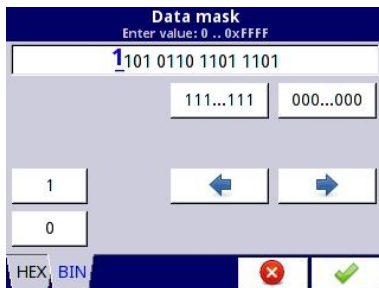

Fig. 7.8. Value editor – binary form



Fig. 7.9. Single choice type editor

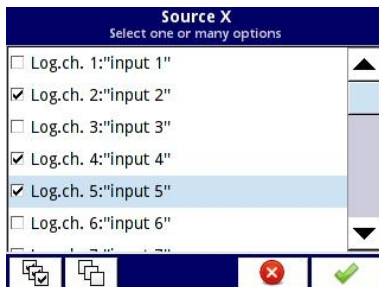

Fig. 7.10. Multiple choice type editor



Fig. 7.11. File editor - single file selection



Fig. 7.12. File editor - multiple file selection

Functions of common buttons

	<p>“Exit” - exits from current menu or sub-menu</p>
	<p>”OK” - accept choice or changes of edit dialogue (and exit from this dialogue)</p>

	“ Cancel ” - reject entered choice or changes of edit dialogue (and exit from this dialogue)
	Selection of element for editing. Arrow buttons allow the user to select successive elements (groups, logical channels, controllers or outputs). The middle button allows a direct selection of particular element from the list.
	Navigation keys in choice type dialogues.
	Move arrows. Allow to move cursor along the edited text.
	“ Caps lock ” - switches between lower and upper case letters.
	“ Backspace ”. When editing values, pressing this button deletes last visible number. When editing text, the last edited symbol shown directly before cursor is deleted.
	“ Clear ” - clears the whole number when editing values.
	“ Sign ” - changes the sign of the edited value.
	This button deletes the selected file.
	“ All ” - selects all the available options.
	“ None ” - deselects all the available options.
	Press this button to enter Text editor window.
	Add a new object
	Delete a selected object

Fig. 7.13. Button functions common for different views.

7.2. MAIN MENU SELECTION PANEL

Pressing the [MENU] button on the **Navigation bar** (see **Chapter 6.3.2. Navigation bar**) enters the main selection panel (see Fig. 7.14). This panel allows users to select between entering the **Device Configuration** menu, **Files management** menu and **Device Information** window.

Further information about the different menus are described in further chapters.

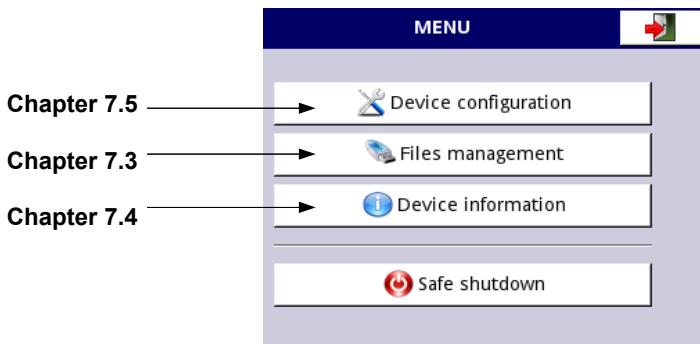

Fig. 7.14. Main menu window

The **Safe shutdown** button allow for a safe power down of the device. After pressing the button and accepting the **warning message** the screen will look like in the Fig. 7.15. Now, the user can power off the device. The manufacturer recommends turning off the device this way. This method is especially recommended when data logging is enabled. Not complying with these instructions could cause loss of recently logged data samples.



Fig. 7.15. The view of the screen after pressing the **Safe shutdown** button

7.3. FILES MANAGEMENT

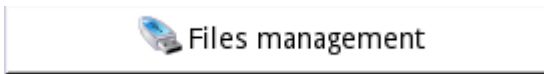

Fig. 7.16. This button allows to entry to the files management menu

After pressing **MENU -> Files management** (see Fig. 7.16) we enter the files management menu which is used to exchange data with a flash drive.

Requirements for a flash drive:

- Maximum current consumption is 100mA. Some flash drives with large capacities are not supported by the device (in this case can use an external USB hub with power supply). The manufacturer recommends the use of flash drives of 2GB in size.
- The flash disk must be formatted for Windows as FAT (NOTE!! not FAT32).
- update files, configurations files, and Modbus templates must be located in the main folder (the root of the drive).

A view of the main menu of **File management** is shown in Fig. 7.18. There are two buttons called **Logging files** and **Configuration files** when in the device has the data logging option activated (more information about the licence key for data logging is located in **Chapter 7.4 DEVICE INFORMATION, LICENSE AND FIRMWARE UPDATE**), otherwise there is only one button named **Configuration files**. To prevent accidental or unauthorized changes to the settings in the **Device configuration** menu and **File management menu**, the user can set an access password. If the user has enabled the access options (see **Chapter 7.16. ACCESS OPTIONS**) then before going to the next menu level they will be asked for a password as in Figure 7.17.



Pressing this button open the text editor window to enter the password. When the user enter the password, characters are replaced with '*'.

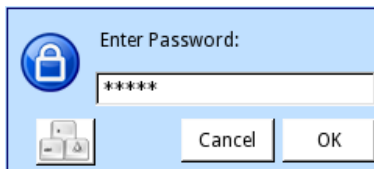

Fig. 7.17. Enter password dialogue

The **Logging files** button (see Fig. 7.18) opens the logging files management menu. This button exists only when the user has input a valid licence for logging data. To export and/or delete logged files follow these steps:

- select a file/s of logged data from a group,
- select the more files in the other groups (if needed),
- export selected files to flash drive,
- and / or delete selected logged data files,

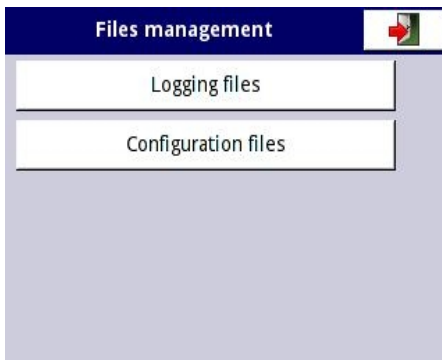

Fig. 7.18. **Files management** menu



Fig. 7.19. View of the **Logging files** menu

The **Logging files** menu is presented in Fig. 7.19. The menu consists of buttons:

- **Export files** - after pressing this button the selected logged files will be exported to a flash drive,
- **Delete files** - after pressing this button the selected logged files will be removed from the device,
- **Press to select** - if the user has enabled the logging of particular group of logical channels (see **Chapter 7.13.2. Groups - Logging options**) in the **Logging files** menu next to the label of the group number appears the button '**Press to select**'. Depending on how many groups (the device can define 10 groups) logging is enabled (past or present) as many '**Press to select**' buttons will be active.

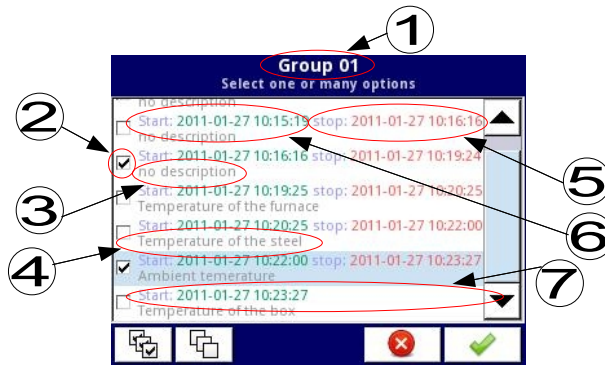

Fig. 7.20. A sample view of selected logged files from Group 1

In Fig. 7.20 presents a sample view of selected logged files from Group 1. The numbers refer to:

- (1) - group number,
- (2) - the selected logged file,
- (3) - no description for the logged file,
- (4) - description defined by the user (a description of the logged file is defined in the Groups menu - see **Chapter 7.13.2. Groups - Logging options**)
- (5) - date and time of the end of the logged data file,
- (6) - date and time of the start of the logged data file,
- (7) - date and time of the start of the logged data file whose logging has not yet ended.

An example of exporting the logged data to a flash drive

An example of exporting 2 logged files from group 1 is shown in Fig. 7.21. First plug the flash drive into the device.

- In step (1), press the button **Press to select** next to the **Group 01** label,
- In step (2), select 2 files by pressing the selected files and then choose the button to accept:
 - File 1. Name: "no description", Start: 2010-12-01 3:24:58 p.m., stop: 2010-12-01 4:34:11 p.m. "
 - File 2. Name: "Ambient temperature" Start: "2010-12-03 9:53:15", stop: "2010-12-03 9:55:00"
- In step (3), press the **Export selected files** button and wait for a message to end the operations of exporting data to a flash drive,

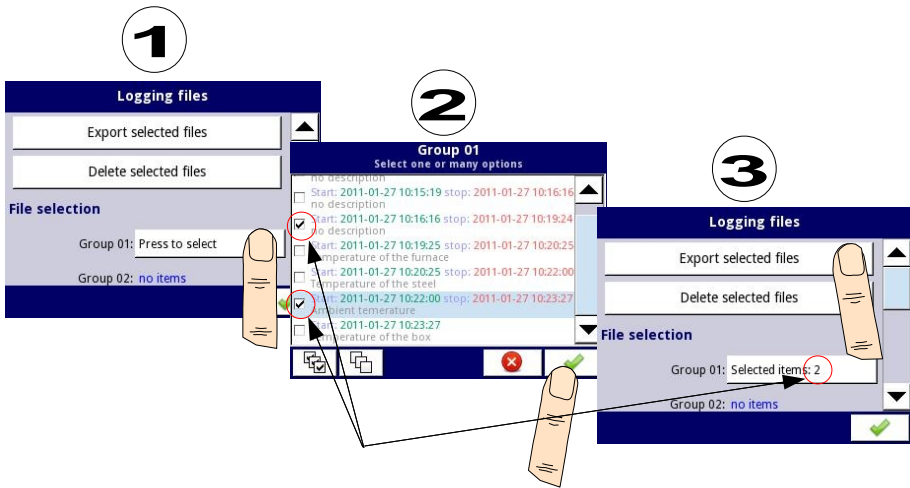

Fig. 7.21. Steps of exporting logged files to flash drive

After exporting logged files a folder is created on the flash drive with the same name as the product identification number, which includes a folder with the selected logged files.

Deleting files from the device is similar export logging files, the difference is that instead of pressing the **Export selected files** button in (3) step (see Fig. 7.21), press the **Delete** button.

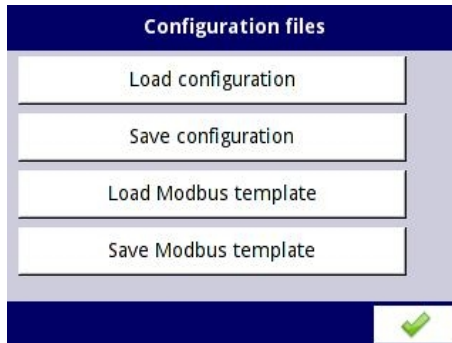

Fig. 7.22. View window when the configuration changes

The second button on the **File management** menu is the **Configuration files** button. Pressing this button, will open the menu shown in Fig. 7.22, which allows the user to load/save the configuration and Modbus templates. **Load/save configuration** will load/save the configuration defined by the user, which includes:

- general settings (see **Chapter 7.7. GENERAL SETTINGS**),
- logical channel settings,
- built-in, external inputs settings,
- built-in, external output settings,
- Modbus protocol settings,

- profile/timer settings,
- control settings,
- network settings,
- group settings,

Load/save Modbus templates allows the user to load/save the configuration of the Modbus protocol, e.g.:

- name,
- configuration of the device channels (the list of inputs and outputs)
- configuration of register blocks (block list) - see **Chapter 7.14. MODBUS**,

Having saved these Modbus templates means the user can at any time quickly establish a connection between the MultiCon and the SLAVE devices, needing only to choose the appropriate address of the SLAVE devices (more about templates in **Chapter 7.14. MODBUS**).

The process of exchanging configuration files or Modbus templates between the MultiCon and flash drive starts when you plug the flash drive to the unit. Then enter **MENU -> File management -> Configuration Files**. If you want to **Load configuration/template** the window panel will show a view of the contents of the flash drive with the available files:

- for **configuration file** with extension **.cfg**,
- for **Modbus template file** with extension **.mcfg**,

Please note that the file name is defined by the user. If the user wants to **Save configuration/Modbus template**, press the **Save configuration** or **Save Modbus template** button. A window appears with the available files that can be overwritten or a new file can be created by pressing  button in the upper left corner (see Fig. 7.23). After confirming the write process the data is stored on the flash drive. An example of configuration files in Fig. 7.23.

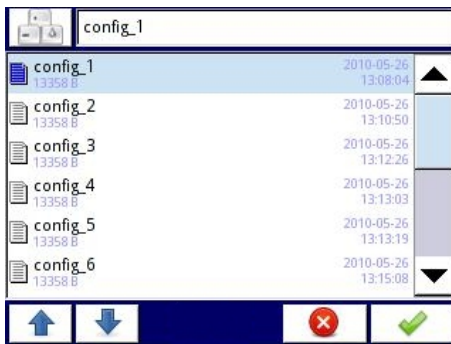

Fig. 7.23. Example of logging and configuration files

7.4. DEVICE INFORMATION, LICENSE AND FIRMWARE UPDATE

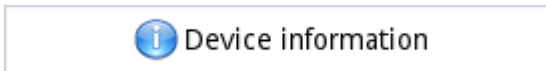

Fig. 7.24. The button which will show information about the device

The **Device information** menu gives basic information about the device and allows the user to enter a licence key for data logging, perform a firmware update of the device and run displaying on the remote screen.

Pressing the **MENU -> Device information** button (see Fig. 7.24) will show window (see example window information Fig. 7.25) with basic information about software and hardware on the device, such as:

- type of device,
- version of the software
- available free memory,
- hardware configuration - a list of installed modules (**number of slot: module type**)
- network settings,
- active licences.

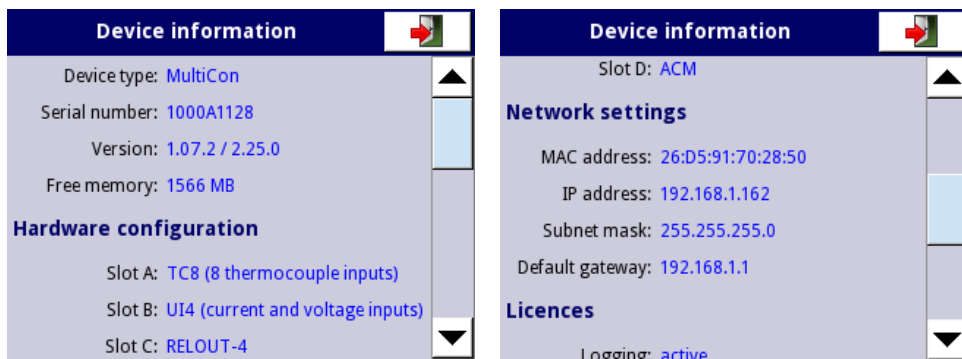

Fig. 7.25. Device Information screen

Enter licence key button (see Fig. 7.26) allows the user to enter a licence key purchased from the manufacturer (or supplier), enabling additional software options which enhance the functionality of the device. After entering and accepting the licence key the device automatically starts up with new software options (if the licence key for data logging is entered the text under the **Licences** heading appears as: **Logging**: the period of validity - see Fig. 7.26).

Firmware update button (see Fig. 7.26) allows the user to update the device software. To perform the update:

- download the latest software version available from the manufacturers website and copy to a flash drive,
- plug in the flash drive - start the update process by pressing the **Firmware update** button (see Fig. 7.26).

Note on the update:

- do not power off the device or remove the flash drive from the USB port during the update,
- the update process must go continuously to the end, the user will be informed of the progress throughout the update cycle;
Attention! The user can not start an unfinished update again because this may damage the device,
- there can not be more than one update file on a flash drive,
- update files must reside in the main folder (root of the drive),
- the update process may take about 5 minutes, depend on the version of the device.

The requirements for removable flash drives are presented in **Chapter 7.3. FILES MANAGEMENT**.

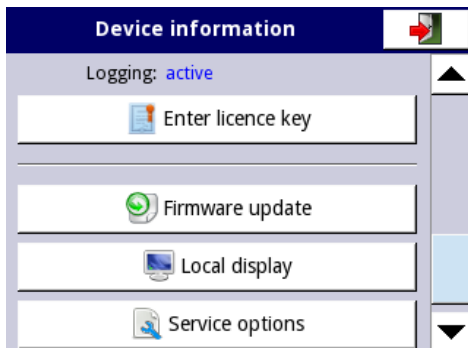

Fig. 7.26. Device information menu

Service options is password protected and unavailable for user.

7.5. DEVICE CONFIGURATION

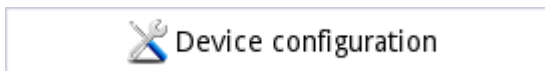

Fig. 7.27. The device configuration menu

The **Device configuration** menu is the main menu of the device that allows the user to configure all inputs and outputs of the device to measure and control the system.

To prevent accidental or unauthorized change the settings in the **Device configuration** menu the user can set the access password. If the user has enabled the access password (see Chapter 7.16. **ACCESS OPTIONS**), before proceeding to the next menu level you will be asked for password as in Fig. 7.28.



Pressing this button displays the keyboard allowing user to enter a password. When entering the password, displayed signs are replaced with '**'.

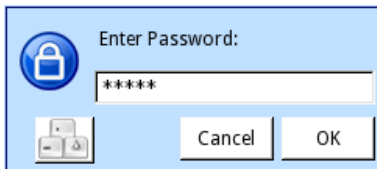

Fig. 7.28. Enter password dialogue

After pressing the **MENU -> Device configuration** button and correctly entering the password (if the user has enabled access protection), the main menu appears as in Fig. 7.29.



More information about selected sub-menus is described in further Chapters.

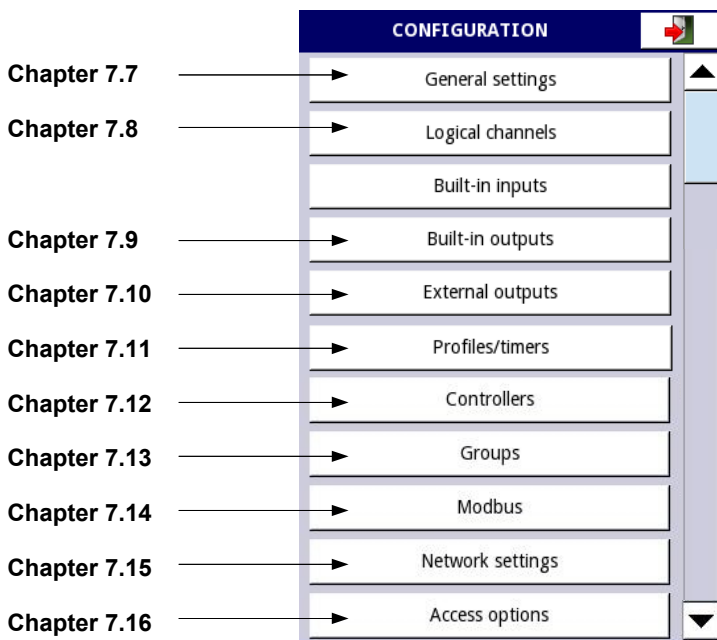



Fig. 7.29. Main menu selection panel

To exit the main menu, press the  button located in the upper right corner of the screen. Due to the fact that the configuration process takes place in real time, all changes must be confirmed before saving them. In the confirmation window, you can **Save** or **Revert the changes** (see Fig. 7.30).

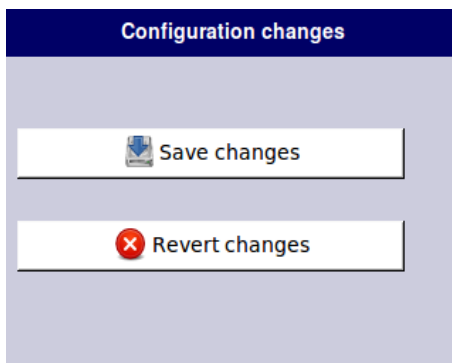
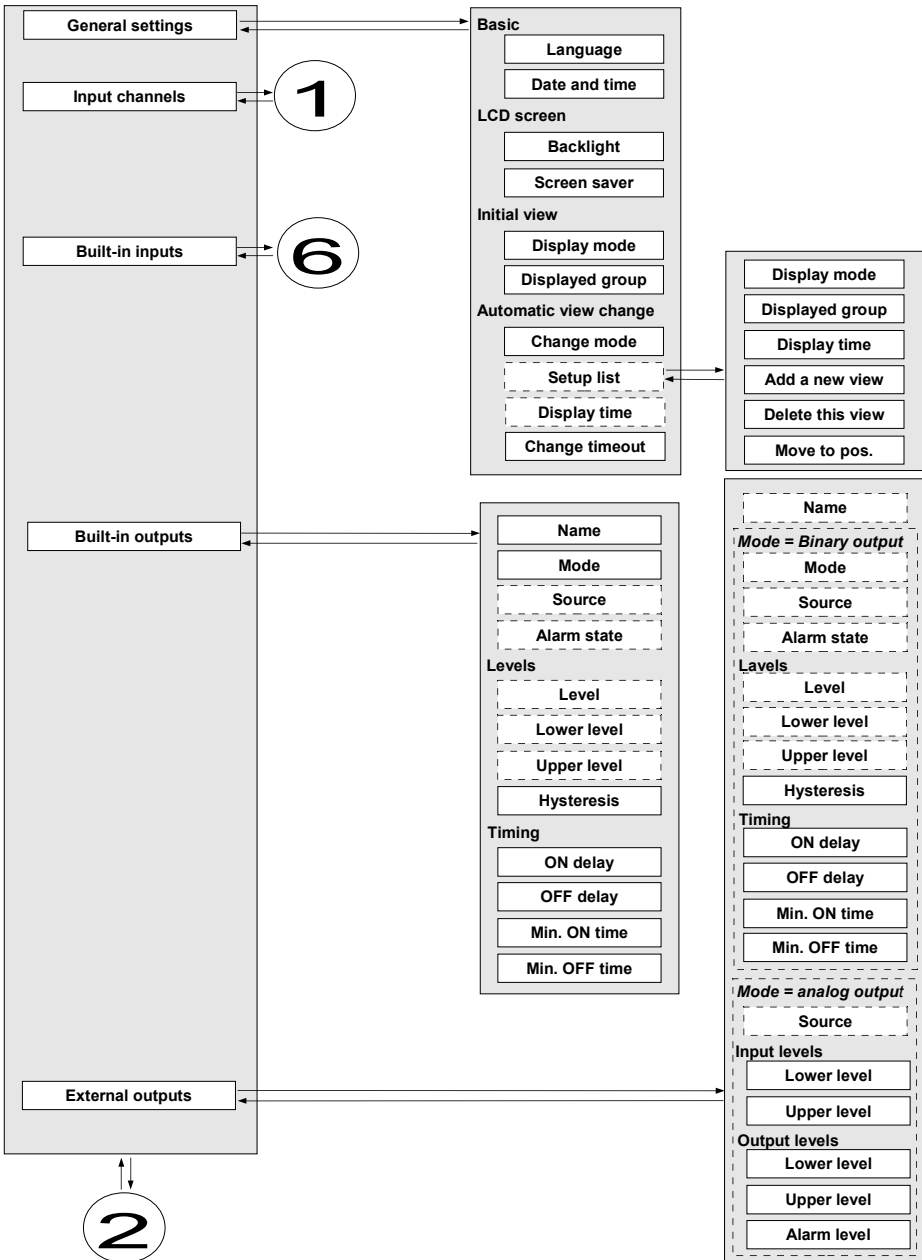
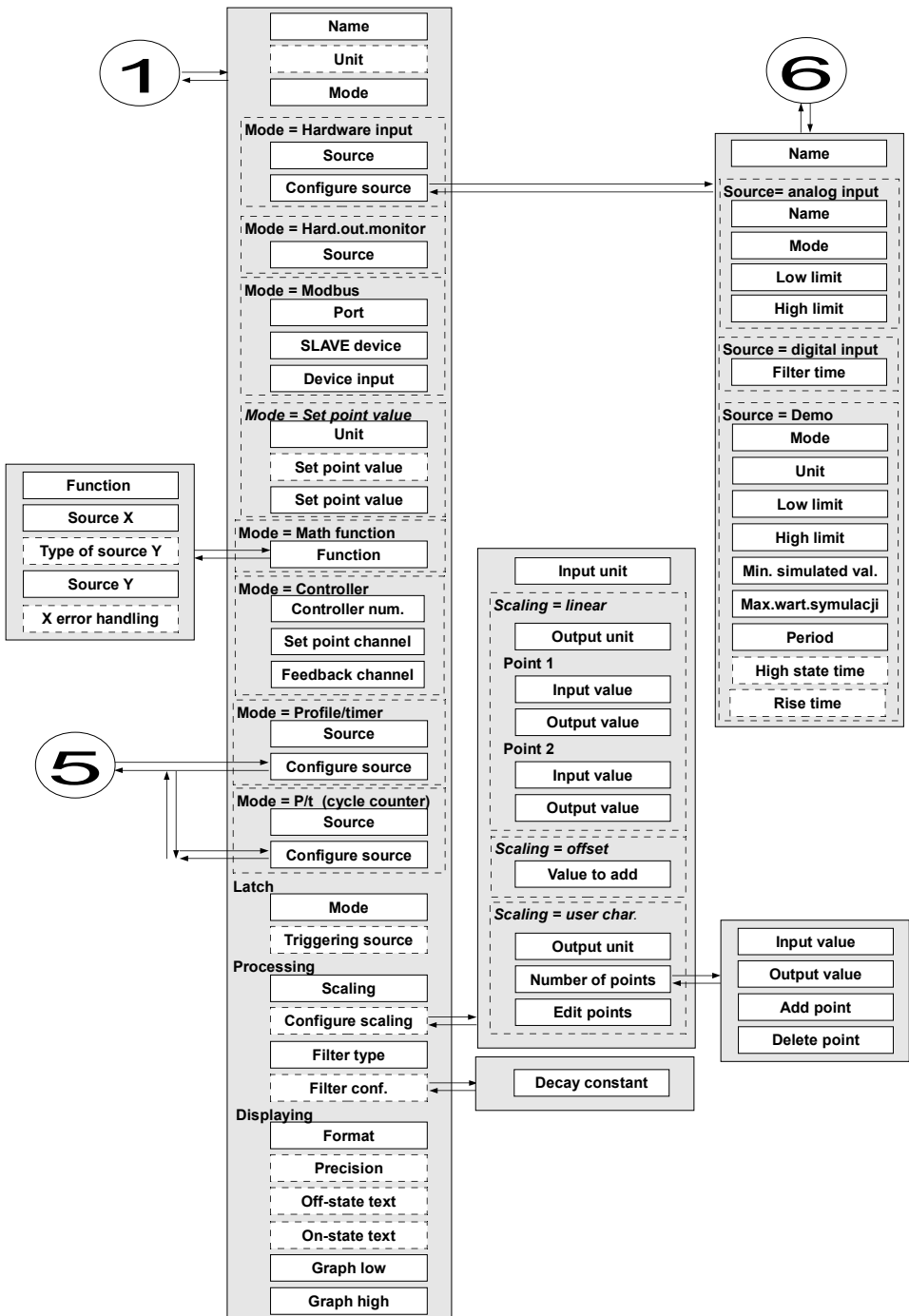
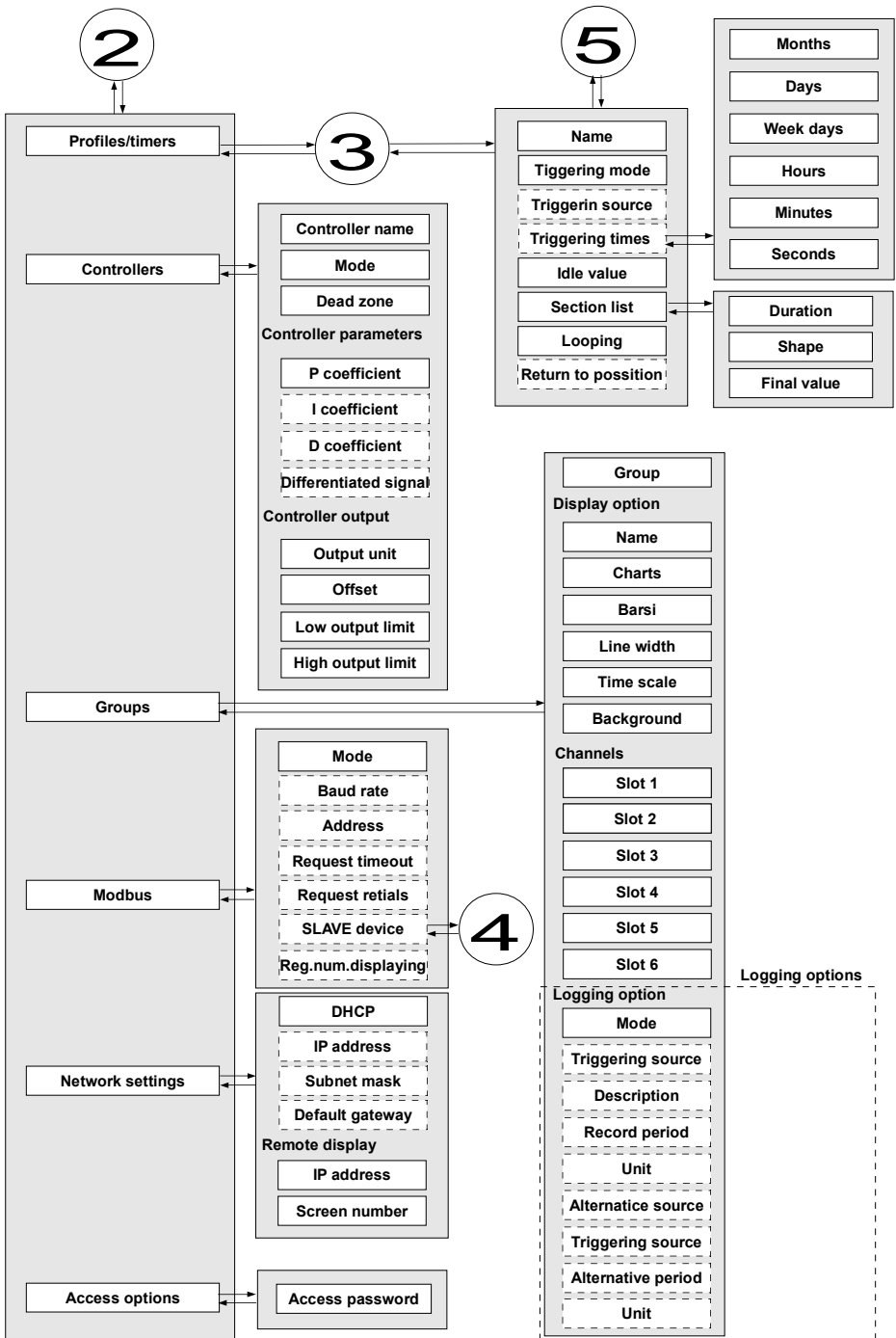

Fig. 7.30. Save / revert changes window

7.6. CONFIGURATION MENU STRUCTURE







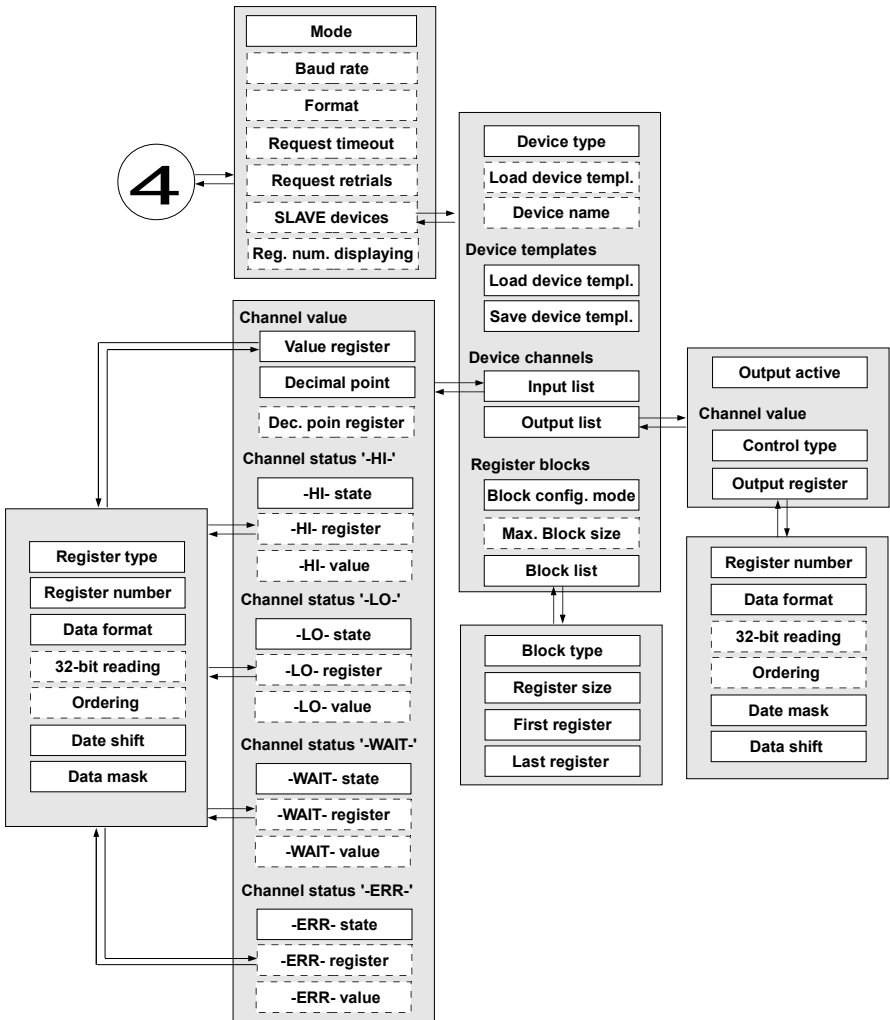

7.7. GENERAL SETTINGS

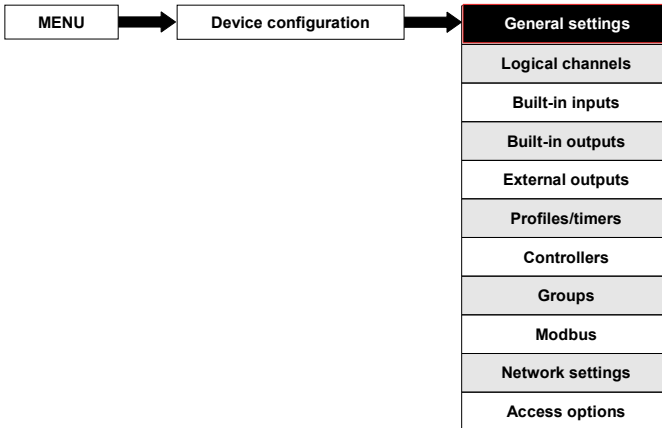

The **General settings** menu allows you to configure user interface display settings, the default screen when the device powers on and automatic view change settings.

The parameters of the **General settings** menu are:

- **Basic** parameter block, this block includes two parameters:
 - **Language** - this parameter allows the user to select the language, available languages are: english, polish, spanish, german, russian, french,
 - **Date and time** - this parameter allows the user to set the current date and time,
- **LCD screen** parameter block:
 - **Backlight** - this parameter allows the user to set the level of the LCD backlight. Available levels are: 20% (least backlight), 40%, 60%, 80%, 100% (the most backlight)
- **Screen saver** parameter block - these parameters can reduce backlight level of the LCD screen (or make it completely blank) during normal operation, ie when the user does not touch the screen for a set time. This block has two parameters:
 - **Mode** - this parameter has the following options:
 - ▶ **disabled** - this option turns off screen savers, the LCD screen is illuminated at all times according to parameter settings: **Backlight** (see above **Screen saver** parameter block)
 - ▶ **1min, 5min, 10min, 30min,**
 - **Brightness** - this parameter is hidden for **Mode = disabled**, in the other modes (1min, 5min, 10min, 30min) this parameter is visible, the user can change the brightness level of the LCD screen after time set in parameter **Mode** elapses. The options are: 0% (screen blank), 20%, 40%, 60%,
- **Initial view** parameter block - this block allows the user to set the initial display screen on the LCD screen when the device is turned on, this block includes two parameters:
 - **Display mode** - select the presentation of data in the displayed group (see parameter: **Displayed group**). For possible modes see **Chapter 6.3.3. Data panels**, and **Chapter 7.13. GROUPS**,
 - **Displayed group** - select a group displayed at startup, if you choose **Display mode = many groups**, the parameter **Displayed group** selects the first group

(**many group** mode presents 5 groups in one window). For example, when the user sets **Display group = Group 8** then the unit will display: starting from the left side of: Group 8 -> Group 9 -> Group 10 -> Group 1 -> Group 2,

- **Automatic view change** parameter block - this parameter block allows the user to set the display to change every time period. The parameters of this block include:
 - **Change mode** - this parameter has the following options:
 - ▶ **disabled** - no changes in the display. For this mode the remaining parameters in this block are not visible,
 - ▶ **change modes** - this option allows the user to automatically change the displayed mode,
 - ▶ **change groups** - this option allows the user to automatically change displayed group,
 - ▶ **detailed list**,
 - **Display time** - this parameter is visible for the **Change mode: change modes, change group** - duration (set in seconds) for each screen,
 - **Setup list** button - this button is visible for **Change mode = detailed list**, this parameter is described below,
 - **Change timeout** - this parameter determines the time from last touching the screen to first view change,

Setup list parameter

After pressing the **Setup list** button the user enters the **View** menu allowing the creation of 1 to 20 views.

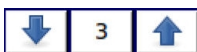

Arrows placed in the upper right corner of the screen allow you to move to the next view. The middle button allows you to directly select a particular view.

Parameters of **View** menu are:

- **Display mode** - this parameter allows you to select the presentation of the data in the displayed group (see parameter: **Displayed group**). For possible modes see **Chapter 6.3.3. Data panels**, and **Chapter 7.13. GROUPS**,
- **Displayed group** - allows you to select a group displayed at startup, if you choose **Display mode: many groups**, the parameter **Display group** selects the first group (mode many group presents 5 groups in one window), for example, when setting the parameter to **Display group=Group 8** then the display will show: starting from the left side of: Group 8 -> Group 9 -> Group 10 -> Group 1 -> Group 2,
- **Display time** - this parameter sets the duration (in seconds) of the selected view,
- **Add a new view** button - adds a new view to the list
- **Delete this view** button - delete selected view from the list,
- **Move to position** - this parameter allows you to move the current view to the appropriate position,

Example:

Steps to create four views are as follows:

1. In the **Change mode** parameter select **detailed list**,
2. Press the **Setup list** button and enter the **View** menu,
3. Set parameters for a first View,

Arrows placed in the upper right corner of the screen allow you to



move to the next view. The middle button allows direct selection of a particular view.

4. To add or delete further views use the **Add a new view** button or **Delete this view** button, respectively,
5. When the user wants to add a view between the existing views, eg between views 2 and 3, user can choose two ways:
 - select the 2nd view (by the arrows in the upper right corner of the screen) and then add a new view by clicking the **Add a new view** button,
 - after adding new view on the end of the list, set the **Move to position** parameter to **value=3**,
6. When finished, the user can see all the defined views by clicking the middle button between the arrows in the upper right corner of the screen,

7.8. LOGICAL CHANNELS

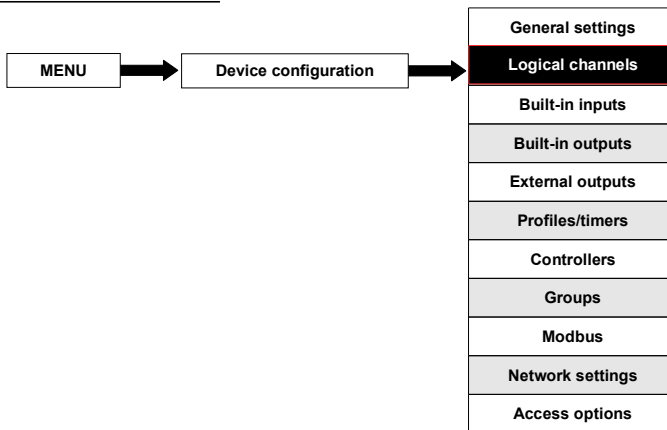

The **Logical channels** menu is used to configure the logical channels. Channels can be treated as input data for outputs, controllers or other **Logical channels** and can be collected into **Groups** for simultaneous display. To see a detailed definition of **Logical Channel** see **Chapter 5.1.1. Logical channels**.



To enter directly into the configuration menu of particular channel, press and hold on the screen over the channel data panel for 3-4 seconds (see option **(1)** in the Fig. 6.4 enter ring configuration of logical channel named **'Temperature'**). If the password is set (see **Chapter 7.16. ACCESS OPTIONS**) then the user has to enter the password before entering the configuration.

7.8.1. Logical Channels - general settings

There are 60 **Logical Channels** available.

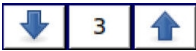

Arrows placed in the upper right corner of the screen allow you to switch between a succession of logical channels. The middle button allows you to directly select a specific logical channel from the list.

The parameters of a logical channel depends on the **Mode** of the logical channel. The **Logical channel** has modes:

- **disabled**
- **Hardware input**
- **Hardware output monitor**
- **Modbus**
- **Set point value**
- **Math function**
- **Controller**
- **Profile / timer**

The channel for **Mode=disabled** has only one parameter - the **name** of the channel. In other modes the **Logical channels** are **active** and may affect the processing and control data.

Parameters and blocks of parameters common for **active Logical channels**:

- **Name** - to rename a channel, press the button next to the **Name** label, and then set any name,
- **Unit** - is related with a data source of channel,
 - for **Built-in modules** it will automatically use a default **Unit**,
 - for **Mode=Set point value** and **Mode=Controller** the **Unit** can be defined freely, directly in the **Logical Channel** menu,
 - for **other modes** the **Unit** can be added only using the **Scaling** parameter (see below in this **Chapter** for discussion about the **Scaling** parameter),
- **Mode** - in this parameter the user selects the source of the data for logical channel. It is possible to select one of eight modes:
 - **disabled**
 - **Hardware input** - see Chapter 7.8.2,
 - **Hardware output monitor** - see Chapter 7.8.3,
 - **Modbus** - see Chapter 7.8.4,
 - **Set point value** - see Chapter 7.8.5,
 - **Math function** - see Chapter 7.8.6,
 - **Controller** - see Chapter 7.8.7,
 - **Profile / timer** - see Chapter 7.8.8,
- **Latch** parameter block - allows user to set the **latch function** which will hold the last value of a channel; this block has the following parameters:
 - **Mode** - this parameter allows the user to choose how to trigger the latch function; there are 2 options:
 - ▶ **disabled** - the latch function is disabled,
 - ▶ **from logic channel** - the latch function is activated depending of the value of channel selected in the **Triggering source** parameter,
 - **Triggering source** - this parameter is only visible if user sets **Mode=from logic channel**; using this parameter the user chooses a logical channel which is the

triggering source of the latch function (when the value of triggering channel is ≤ 0 the latch is **active**, for a value >0 latch is **disabled**),



During device restart, the logical channels, which have the latch function enabled have value: '0' and on the LCD screen blinking dashes '----' appear in place of the value.

- **Processing** parameter block - is used for scaling and filtering data (for explanation see below)
- **Displaying** parameter block - for these parameters the user selects the format and range of the data displayed on the screen. For more information about **Displaying** parameters see below in this **Chapter**.

Processing parameter block

For this block the parameters are: **Scaling** and **Filter Type**.

To enter the scaling menu press the button next to the **Scaling** label. The menu has the following options:

a) disabled - no scaling of input data,

b) linear - in the **Configure scaling** menu for **linear** scaling, the user can change the **Unit** of the displayed data and can linearly scale the result using 2 data points.

Suppose that the data before scaling is denoted by a '**x**' and after scaling by '**y**'. The linear scaling function with parameters '**a**' and '**b**' is given by:

$$y = a \cdot x + b$$

For **Point 1** we have,

$$y_1 = a \cdot x_1 + b$$

where **x**₁ is the input value and **y**₁ is the output value for Point 1

For **Point 2** we have,

$$y_2 = a \cdot x_2 + b$$

where **x**₂ is the input value and **y**₂ the output value for Point 2

Example (see Fig. 7.31):

We want to scale the input signal where the output value half of input value. The output signal is also shifted positively with a value of 5 and the **Unit=A**. The scaling function is given by formule:

$$y = \frac{1}{2} \cdot x + 5$$

For **Point 1** enter values:

x=0, y=5

For **Point 2** enter values:

x=10, y=10

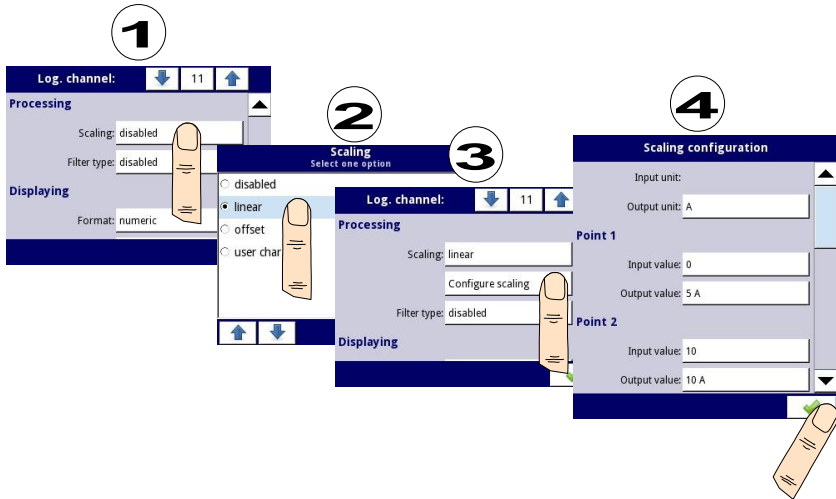

Fig. 7.31. Example of scaling configuration

c) offset - this function offset the data input by a fixed positive or negative value. The offset function is given by:

$$y = x + b$$

, where **x** - is the input value
y - output value
b - offset value

To offset the data input with a certain value the user must select **Scaling=offset** and press the **Configure scaling** button and then enter the value by pressing the button next to the **Value to add** label.

d) user characteristics - is defined as set of X-Y points. Number of the points is variable and may be set from 2 to 20 points which make linear segments (see Fig. 7.32). For 2 points the user characteristic behaves like a linear process (see subsection **b**)). For more than 2 defined points the user characteristic is a composite of the line characteristics therefore for input value '**x**' the user obtain an output value '**y**' which is described by the relationship:

$$y = a_n \cdot x + b_n$$

, where '**a**' and '**b**' are coefficients of a segment contained between two points (see Fig. 7.32), and **n = 1, 2 ..** is the number of the segment.

If the input exceeds the extreme '**x**' values of the designated points of **P_n**, the output value is scaled by the functions defined at the extreme segments.

Example:

Steps to create a user characteristic consisting of 6 points:

1. Press the button next to the **Scaling** label and select **user characteristic** option (point **(1)** and **(2)** in Fig. 7.33).

2. Press the **Configure scaling** button and enter the **Scaling configuration** menu (point **(3)** in Fig. 7.33).
3. If you want to create an output **Unit**, which replaces the input unit, or if no unit is defined on the input, press the button next to **Output Unit** label.
4. Press the **Edit points** button (point **(4)** in Fig. 7.33) and go to **Edit points** menu.



The arrows placed in the upper right corner of the screen allow you to switch between points. The middle button allow direct selection of a particular point from the list.

For **Point 1** set input and output value (point **(5)** in Fig. 7.33).

5. Switch to **Point 2** by using the arrow keys and there also set the value of input and output (point **(6)** in Fig. 7.33).
6. To **add** or **delete** points the user should use the **Add point** button or **Delete point** button, respectively,
7. When the user wants to add a new point between the existing point eg between 5 and 6, select the edit **Point 5** and then add a new point by press the **Add point** button.
8. At the end we check all the points defined by clicking the middle button between the arrows in the upper right corner of the screen (point **(8)** and **(9)** in Fig. 7.33).

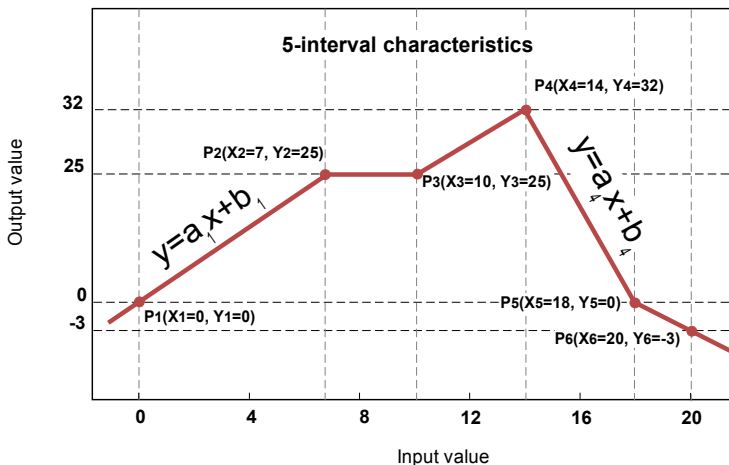

Fig. 7.32. Example of user characteristic

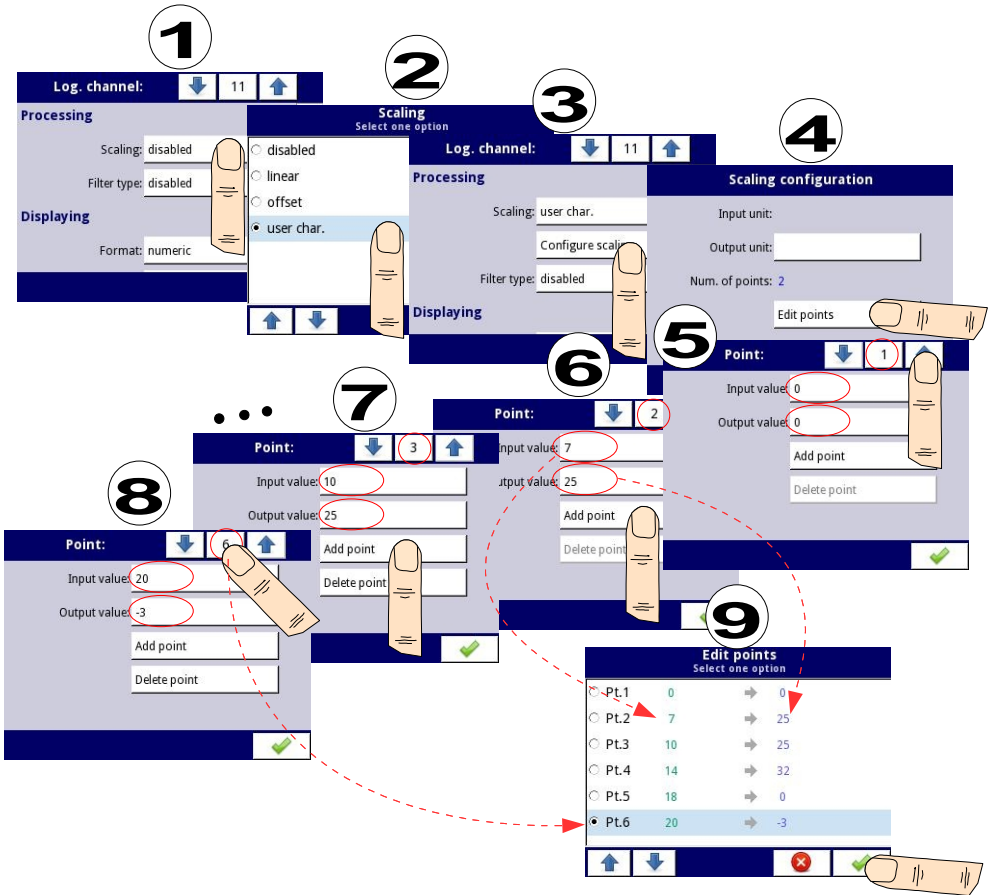

Fig. 7.33. Configuring the user characteristic

Filter type

The **Filter type** parameter has options:

- **disabled** - filtering of the input value is turned off,
- **exponential** - this option enables a filter that is expressed by the formula:

$$Y_n = X_n \cdot \left(1 - e^{-\frac{0,1 \text{ sek.}}{w}}\right) + Y_{n-1} \cdot e^{-\frac{0,1 \text{ sek.}}{w}}$$

,where

n - number of sample, where n = 1, 2, 3 ...,

Y_n - output value for n-th sample,

Y_{n-1} - output value for n-1 sample,

X_n - input value for n-th sample,

w - time constant in seconds, this filter coefficient is defined by the user from the **Decay constant** parameter (a value of '0' for the filter is turned off),

0.1 sec. - sample time,

After selecting **Filter type= exponential** new button is available - **Filter configuration** which allows the user to enter a time constant with the **Decay constant** parameter (see above filter formula).

Example:

An example of the filtered input signal with a step change from **10 to 15** for **time constant of= 10s** is shown in Fig. 7.34.

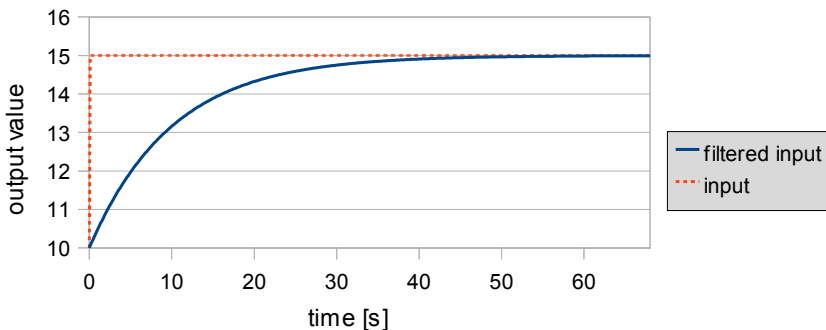

Fig. 7.34. Example of the filtered input signal for the **time constant = 10s**

Displaying parameter block

The constant parameters of **Displaying** block are:

- **Format** - the logical channel data formats, which are:
 - **numeric**,
 - **binary** - only for values: '0' for low state and '1' for high state,
- **Precision** - this parameter is for **Format=numeric**, which specifies the precision to be displayed on the output value. The user can set: 0 (no decimal point), 0.0, 0.00 (Fig. 7.35), 0.000, 0.0000 (to 4 decimal places). The default is '0',
- **Off-state text** - this parameter is for **Format=binary**, for when the input value is ≤ 0 the value is replaced by the text defined by the user, for default settings text is: **OFF**,
- **On-state text** - this parameter is for **Format=binary**, for when the input value is >0 the value is replaced by the text defined by the user, for default settings text is: **ON**,
- **Graph low** - minimum range value for graphs, bars, needle dials and percentage bars (see Fig. 7.35),
- **Graph high** - maximum range value for graphs, bars, needle dials and percentage bars (see Fig. 7.35),

The text of **Off-state** and **On-state** can be:

- text with black font such as: ALARM, off, OK,
- text using numbers and special characters such as: ALARM_ #12

- text using font color and / or a background color for example: **OFF** **DN**
- no text, only a rectangle with the selected color - the width of the rectangle on the screen is defined by pressing the **Spacebar** (empty string), and the color of the rectangle is the background color, for example:

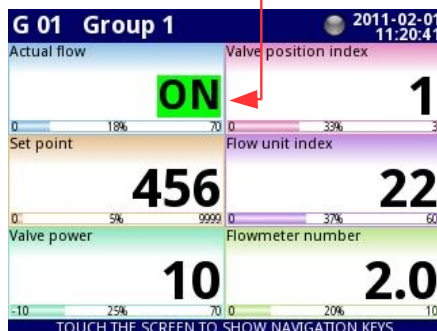
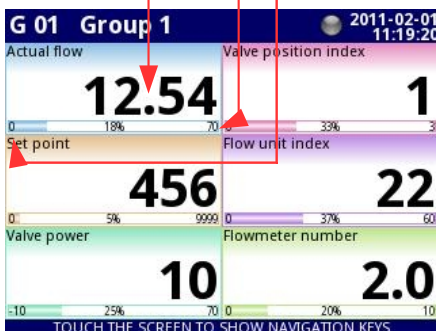
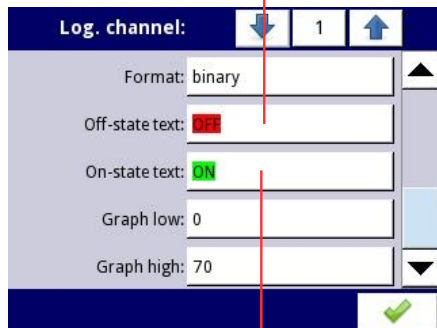
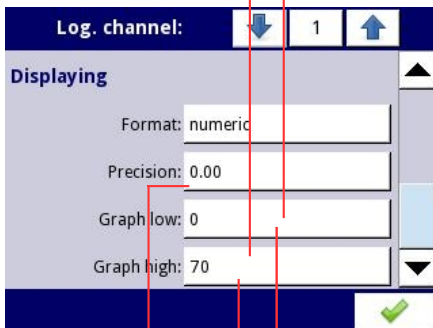
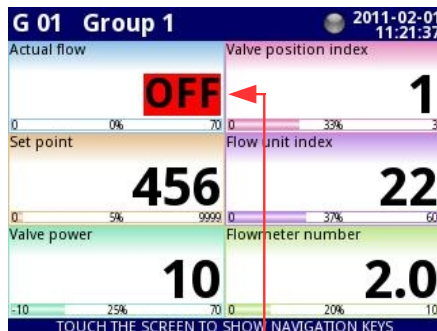
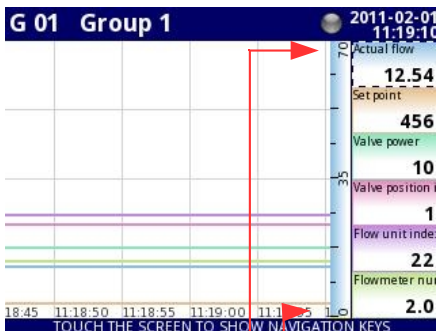
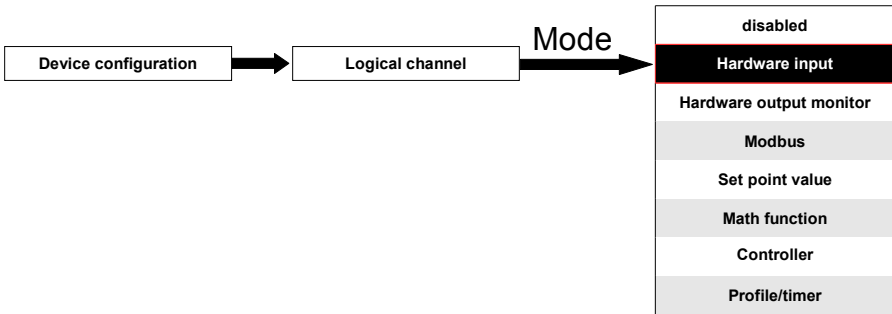

Fig. 7.35. Input channels menu – 2 different kinds of Displaying parameters

Comments regarding the display:

- Precision of the display data can be set in the device with any accuracy (up to 4 decimal places), it must be remembered that the resolution and accuracy of external sensors connected to the device is finite, and usually not better than 0.1%.
- Time scale is common for the entire **Group** and can be set in the **Groups** menu (see **Chapter 7.13. GROUPS**).

7.8.2. Logical channels in Hardware input mode



This mode allows the user to measure data from installed input modules which can be displayed, and/or processed in any other logical channels (e.g. by math function or virtual relay) or it can be the data source for controlling outputs.

The Logical channels parameters in Hardware input mode are:

- **Name** - to rename a channel, press the button next to the **Name** label, and then set any name,
- **Unit** - for **Built-in modules** it will automatically use the default **Unit**, to change the unit use the **Scaling** parameter,
- **Mode=Hardware input** - in this parameter user can select the source of the data for the logical channel,
- **Source** - in this parameter user selects the source of the data from the hardware input list for the logical channel (see below in this **Chapter**),
- **Configure source** button - after pressing this button user can change the source configuration, eg the range of the input value (see below in this **Chapter**)
- **Latch** parameter block - allows user to set the **latch function** which will hold the last value of a channel (discussed in **Chapter 7.8.1. Logical Channels - general settings**),
- **Processing** parameter block - is used for scaling and filtering data (discussed in **Chapter 7.8.1. Logical Channels - general settings**)
- **Displaying** parameter block - these parameters allow the user to select the format and range of the data displayed on the screen (discussed in **Chapter 7.8.1. Logical Channels - general settings**),

Source parameter in **Hardware input** mode.

After pressing the **Source** button a list of available hardware inputs appears. The selected option will be the source of the data for this logical channel. A sample list of available hardware inputs for a device with only one input module, eg **I16** - 16 current inputs (see

Appendix 8.2 UI4, UI8, U16, I16, FI4 - VOLTAGE, CURENT AND FLOW MEASUREMENT MODULES) is shown in Fig. 7.36.

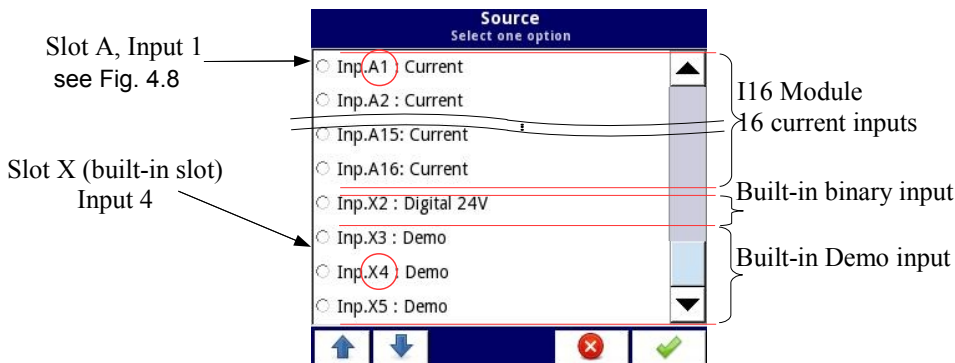

Fig. 7.36. The view of a sample list of available hardware inputs for a device

The **Source** for **Hardware input** mode can be (in the same order as list in the device - see Fig. 7.36):

a) installed **input modules** in the appropriate slots A, B or C (see Fig. 4.8) - the list of currently available modules is on the website,

Input modules

Short description of configuration of the physical input is shown in Fig. 4.9-4.14 and is dependent on specific measurement modules. In **Configure source** menu (press **Configure source** button to enter **Source configuration** menu) for the module the user can:

- change the ranges covered (depending on module), see **Appendix 8. APPENDIX - input and output modules description**,
- change the connection method - it depends on the module (see **Appendix 8. APPENDIX - input and output modules description**).
- change the type of reading of the input signal - depending on the module, e.g. a thermocouple module can read the temperature and voltage (see Fig. 7.37),

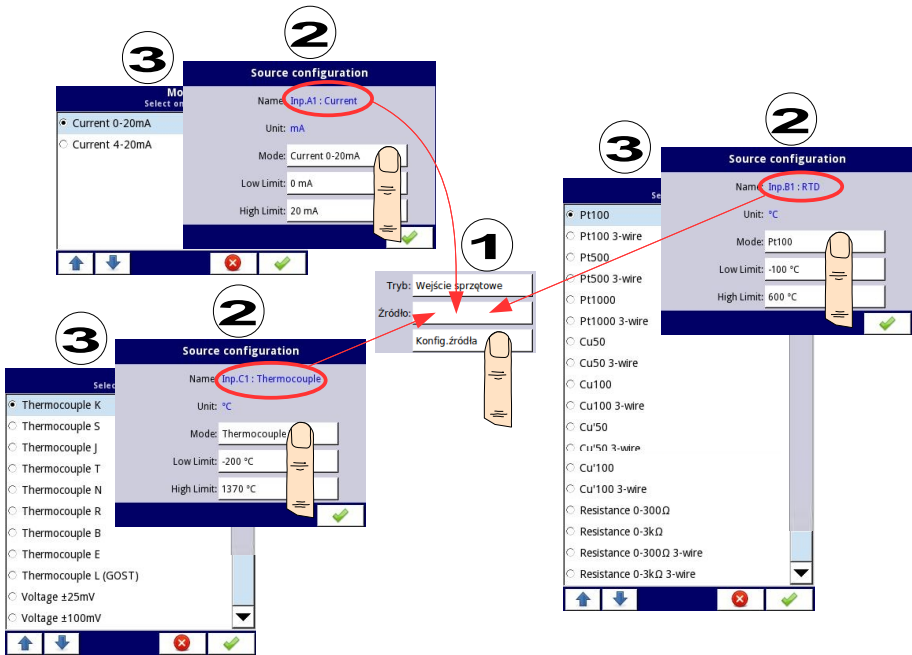

Fig. 7.37. Change source configuration for different types of modules

The following steps change the **Source configuration** for the sample of 3 modules shown in Fig. 7.37:

- Step (1) - selection of **Source** for channel in **Hardware input** mode, for example: **Inp.A1:Current**, next press the **Configure source** button to enter **Source configuration** menu,
- Step (2) - press the **Mode** button to change range of the current input,
- Step (3) - choose from the list of available options for signal range - for example: **Current 0-20mA** (for current module),

b) built-in digital input is always designated as **Inp.X2: Digital 24V**

Inp.X2 : Digital 24V

The device has a built-in digital input, which can be used, for example as a switch for a process. Specifications of digital input are included in **Chapter 3. TECHNICAL DATA**. This digital input has levels:

	input voltage [V]			digital input
	min	typ	max	
low level	0		5	0
prohibited level	>5		<8	x

high level	8		24	1
------------	---	--	----	---

The **Source configuration** menu of the digital input **Inp.X2. : Digital 24V** is limited to a single parameter - **Filter time** in which we can change the filter time from 0 to 1000 seconds. Filtering is disabled (0 sec.) by default. The **Filter time** parameter determines how quickly the input can change as noticed by the device. Filtration can be used if:

- contact bounce occurs when switching,
- you deliberately want to reduce the maximum frequency of the input.

Example:

When the **Filter time** parameter is set to 1 sec. then input changes which appear quicker than 1 second will be ignored.

c) built-in **Demo** input numbered **X3, X4, X**,

Inp.X3:Demo, Inp.X4: Demo, Inp.X5: Demo

The device has 3 built-in simulation **Demo** inputs which can be defined by the user. The configuration contains parameters:

- **Mode:**
 - **rectangle**,
 - **triangle**,
 - **sine**,
- **Unit** - any user-defined unit,
- **Low limit** - the value below which there is a low state at the output displayed as status '-Lo-',
- **High limit** - the value above which there is a high state at the output displayed as status '-Hi-',
- **Minimum simulated value** - for the Demo signal selected in **Mode** parameter,
- **Maximum simulated value** - for the Demo signal selected in **Mode** parameter,
- **Period** - duration (in seconds) of one cycle of the Demo signal selected in Mode parameter,
- **High state time** - this parameter is displayed only for the **rectangle** mode,
- **Rise time** - this parameter is displayed only for the **triangle** mode,



You cannot use Demos which have the same modes and configuration of parameters, for example, you can not configure 2 Demos in sine mode which have periods of 10 sec. and 20 seconds.

Example configuration of a **Demo** for sinus mode shown in Fig. 7.38.

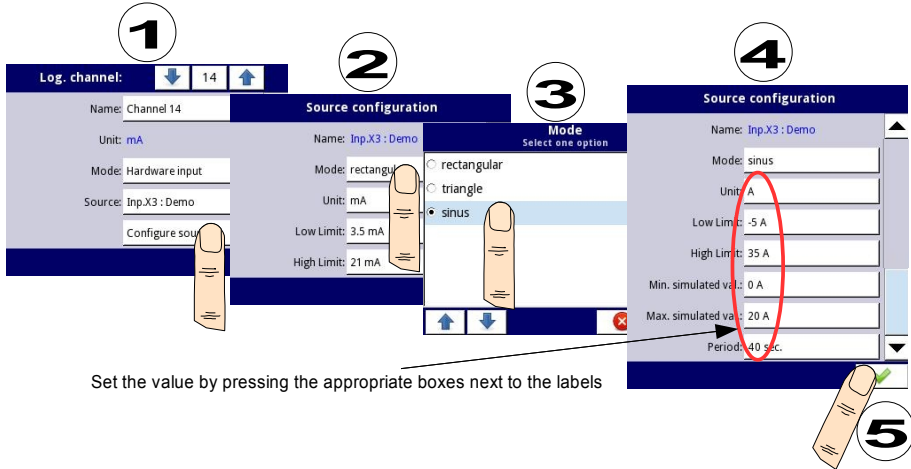
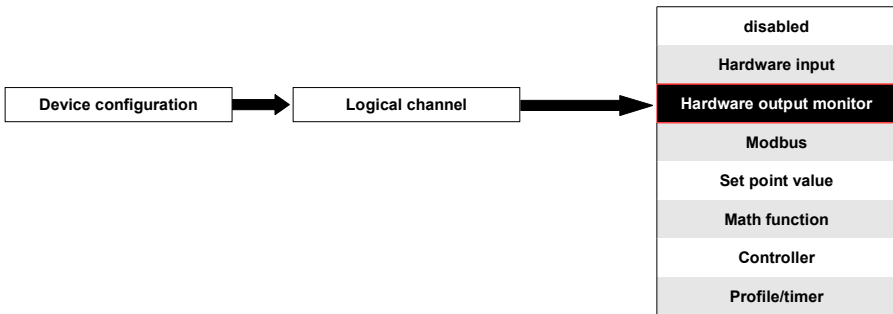

Fig. 7.38. Example configuration of Demo

7.8.3. Logical Channels in Hardware output monitor mode



This mode allows the user to display data from built-in output modules, processed in any other logical channels (e.g. by math function or virtual relay) or it can be the data source for controlling another output.

A view of the configuration of a **Logical channel** in **Hardware output monitor** mode is shown in Fig. 7.39.

The parameters of a **Logical channel** in **Hardware output monitor** mode are:

- **Name** - to rename a channel, press the button next to the **Name** label, and then set any name,
- **Unit** - for **Built-in modules** it will automatically default to the unit of the module. To change the unit use the **Scaling** parameter,
- **Mode=Hardware output monitor** - in this parameter user selects the source of data for logical channel,
- **Source** - in this parameter user selects the source of data from the available built-in outputs list for the logical channel (see below in this **Chapter**),
- **Latch** parameter block - allows the user to set the **latch function** which will hold the last value of a channel (discussed in **Chapter 7.8.1. Logical Channels - general**

- settings),
- **Processing** parameter block - is used for scaling and filtering data (discussed in **Chapter 7.8.1. Logical Channels - general settings**)
- **Displaying** parameter block - these parameters allow the user to select the format and range of data displayed on the screen (discussed in **Chapter 7.8.1. Logical Channels - general settings**),

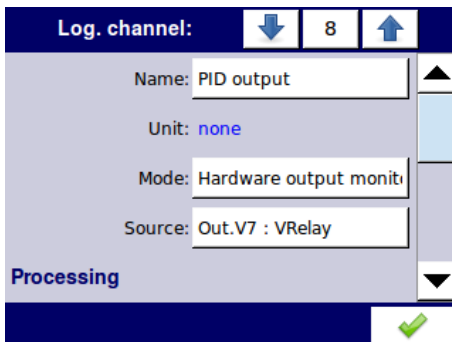

Fig. 7.39. Input channels menu – parameters specific for **Hardware Output Monitor** mode

Source parameter in the **Hardware output monitor** mode.

After pressing **Source**, a list of available hardware outputs appears. The selected option will be the source of data for that logical channel. An example list of available hardware outputs for the device with only one output module such as **R81** - 8 relay outputs module (see Appendix 8.9. R45, R81 - RELAY MODULES) is shown in Fig. 7.40.

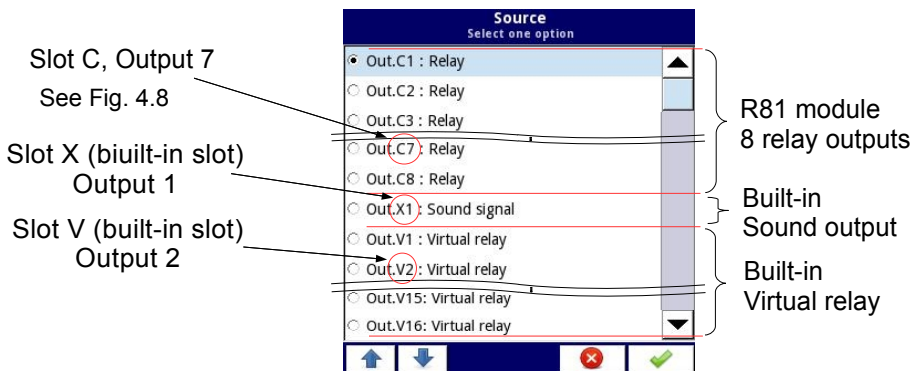
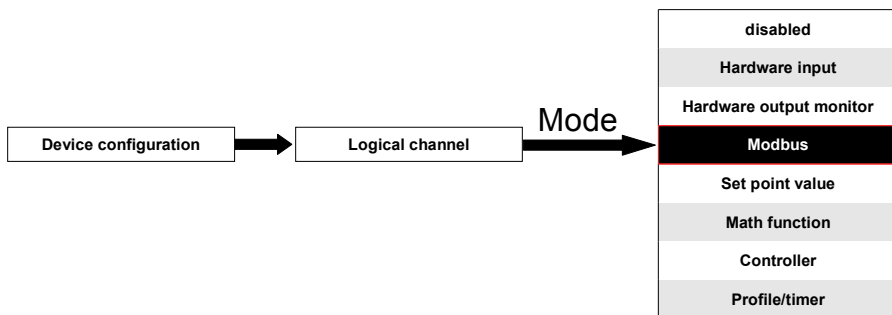

Fig. 7.40. Sample list of available hardware outputs

Source for the **Hardware output monitor** mode can be (in the same order as in the list in device - see Fig. 7.40):

- installed hardware output modules in the respective slots A, B or C (see Fig. 4.8) - a list of modules currently available is on the website; more about the output modules in **Chapter 7.9. BUILT-IN OUTPUTS**,
- built-in **Sound signal** output is always marked as **Out.X1: Sound signal** - more about the **Sound** outputs is in **Chapter 7.9. BUILT-IN OUTPUTS**,
- built-in **Virtual relays** marked as **Out. V1 - V16** - more about Virtual relay in **Chapter 7.9. BUILT-IN OUTPUTS**.

7.8.4. Logical Channels in Modbus mode



This mode allows the user to display data from SLAVE devices communicating with the MultiCon by serial port (Modbus). This data can be processed in other logical channels (e.g. by math function or virtual relay) or it can be the data source for controlling an output.

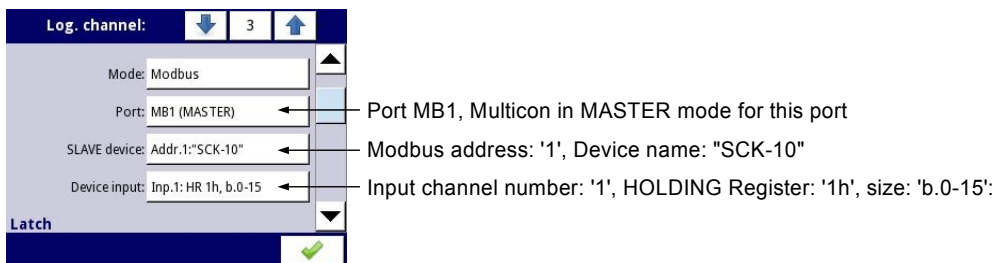

Fig. 7.41. Sample Logical channel setting in Modbus mode

An example configuration of **Logical channel** in **Modbus** mode is shown in Fig. 7.41.

The parameters of **Logical channel** in **Modbus** mode are:

- **Name** - to rename a channel, press the button next to the Name label, and then set any name,
- **Unit** - to create a unit use the **Scaling** parameter (more information see **Chapter 7.8.1. Logical Channels - general settings**),

- **Mode=Modbus** - in this parameter the user selects source of data for logical channel,
- **Port** - this parameter allows the user to select a serial port from the list, the basic version of MultiCon has one built-in RS-485 port. The number of serial ports can be increased by installing a communication module into slot D of the device (Fig. 7.42). This module offers 2 additional serial ports (one RS-485, and one RS-485/RS-232), which allows an advanced Multi-Modbus system.
- **Slave device** - this parameter is only visible if the selected option in the **Port** parameter is in **Modbus MASTER** mode (see **Chapter 7.14.3. Modbus - MASTER mode**). Using this parameter the user can select the SLAVE device from the list defined in the **Modbus** menu,
- **Device input** - this parameter is visible only if the selected option in the **Port** parameter is in **Modbus MASTER** mode (see **Chapter 7.14.3. Modbus - MASTER mode**), using this parameter the user can select the read register of SLAVE device from the list defined in the **Modbus** menu,
- **Latch** parameter block - allows user to set the **latch function** which will hold the last value of a channel (discussed in **Chapter 7.8.1. Logical Channels - general settings**),
- **Processing** parameter block - is used for scaling and filtering data (discussed in **Chapter 7.8.1. Logical Channels - general settings**)
- **Displaying** parameter block - these parameters allow the user to select the format and range of data displayed on the screen (discussed in **Chapter 7.8.1. Logical Channels - general settings**),

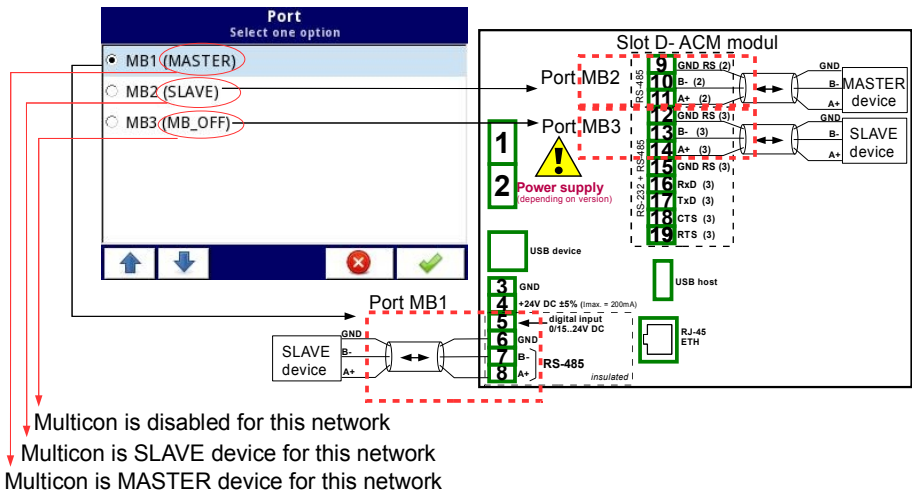

Fig. 7.42. Sample list of available Modbus ports



Logical channel's in Modbus mode reading registers from Slave devices that are not connected, will returns an error and instead of the value will display the state **-ERR-**.

For more information about the Modbus protocol implemented in the MultiCon see **Chapter 7.14. MODBUS**.

7.8.5. Logical Channels settings for Set point value mode

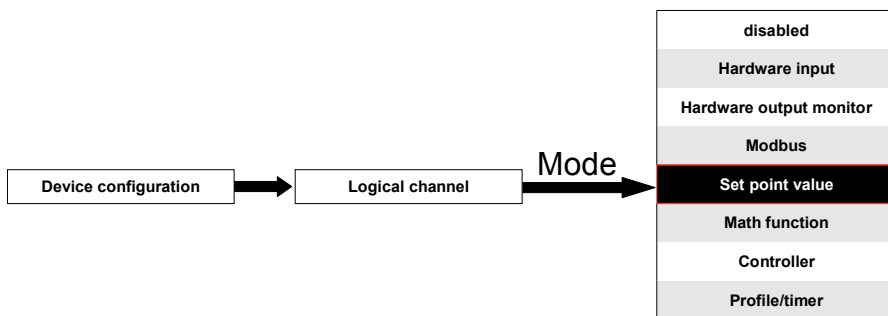

This mode allows the user to define the set point value for display on the screen, processed this data in any other logical channels (e.g. by math function or controller, etc.) or it can be the data source for output to the control and settings of any object.

The parameters of the **Logical channels** in **Set point value** mode should be:

- **Name** - to rename a channel, press the button next to the Name label, and then set any name,
- **Mode=Set point value** - in this parameter user selects source of data for logical channel,
- **Unit** - this parameter allows the user to define any unit,
- **Set point value** - this parameter is visible only if **Edit button=disabled**, after pressing the button next to **Set point value** parameter appears in window allowing entry of a value (see Fig. 7.6), this value will be a source of data for this Logical channel.
- **Edit button** - this parameter allows you to activate the button in the panel data (see Fig. 7.43), this parametr has two options:
 - **disabled** - the button is disabled on the display, in this case the data source of logical channel will be the value set in the **Set poin value** parameter, see Fig. 7.44,
 - **enabled** - this button is active, in this case the data source of logical channel will be the value set after pressing the button,
- **Latch** parameter block - allows user to set the **latch function** which will hold the last value of a channel (discussed in **Chapter 7.8.1. Logical Channels - general settings**),
- **Displaying parameter block** - for these parameters the user select format and range of data to be displayed on the screen (discussed in Chapter 7.8.1. Logical Channels - general settings),

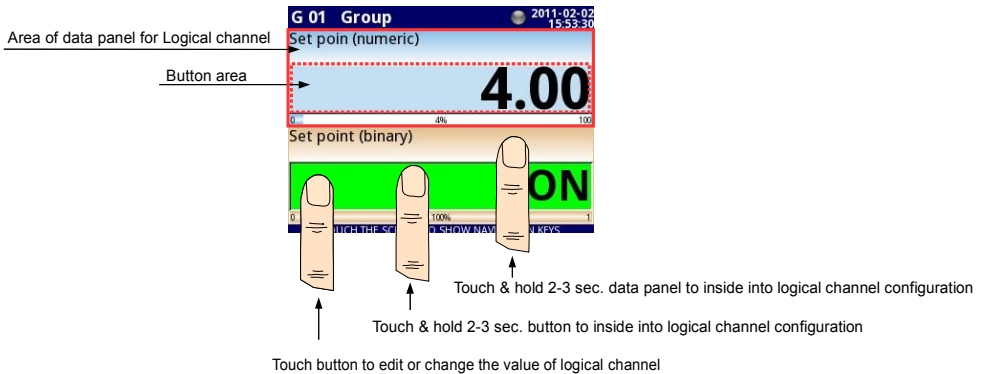

Fig. 7.43. Data panels for Logical channel in **Set point value** mode

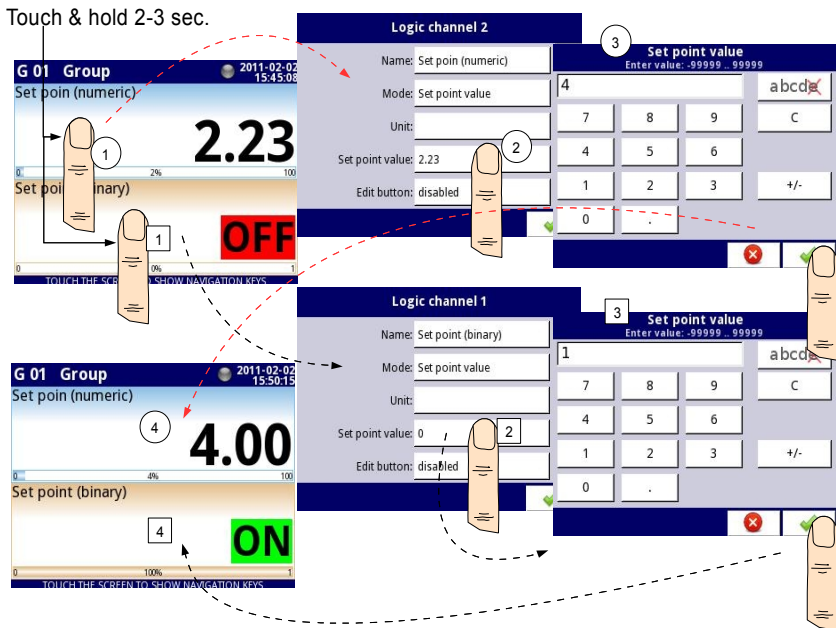

Fig. 7.44. Configuration of the value for Logical channel in **Set point value** for the disabled button

Manual operation of a button in the data panel

Action button in the data panel depends on the **latch** function set in the **Latch** parameter block (description of the **Latch** parameter block in Chapter 7.8.1. Logical Channels - general settings) and on the **Format** parameter in the **Displaying** parameter block (description of the **Displaying** parameter block in Chapter 7.8.1. Logical Channels - general settings).

a) for disabled latch function, see Fig. 7.45

For format:

- **numeric** - after pressing the button an edit window appears allowing entry of value (see Fig. 7.6), this value will be a source of data for that Logical channel,
- **binary** - pressing the button causes a switch between the states ('0' and '1') display in the data panel in accordance with the text states set in the parameters: **Off-state text** (channel value = '0') and **On-state text** (channel value = '1') in the **Displaying** parameter block,

b) for enabled latch function

For format:

- **numeric** - after pressing the button an edit window appears allowing entry of value (see Fig. 7.6), which enters the new value that isn't a data source for this channel but the value stored at the time of activation of the latch function, in the edit window the value of the button still appears a new value which will be the data source for that logical channel by disabling the latch function,
- **binary** - pressing the button does not switch between the states ('0' and '1') displayed in the data panel in accordance with the text states set in the parameters: **Off-state text** (channel value = '0') and **On-state text** (channel value = '1') in the **Displaying** parameter block, but with each new press of the button the state of button is stored in the buffer and set the value of logical channel with the currently stored state when the latch function is disabled again.

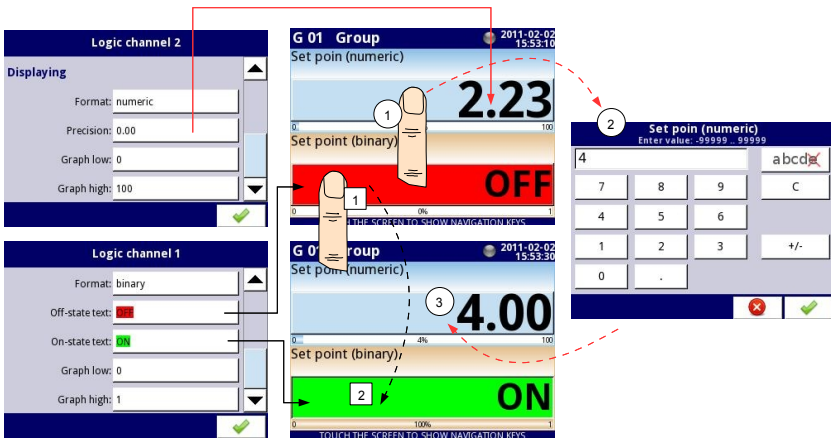
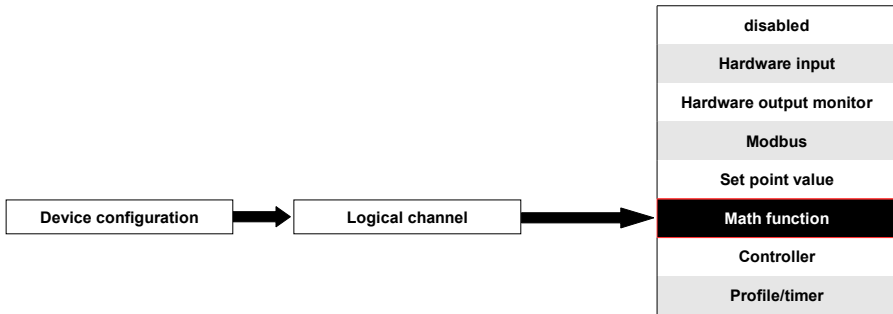

Fig. 7.45. Manual operation of the button for numeric and binary format

7.8.6. Logical Channels settings for Math function mode



MultiCon has a wide variety mathematical function which increases functionality and the range of the applications of the device. Fig. 7.46 presents parameters of **Input channel** into **Math function** mode. This mode allows the user to display channel value, process this data in any other logical channel or it can be the data source for an output to control and set any object.

The screenshot shows the 'Log. channel:' configuration screen. At the top, there is a dropdown menu with '1' selected and up/down arrows. Below this, the 'Name' field contains 'Channel 1'. The 'Unit' is set to 'none'. The 'Mode' is set to 'Math function'. The 'Function' field contains '[2] + [3]'. At the bottom, there is a 'Processing' block with a green checkmark icon.

Fig. 7.46. Input channels menu - parameters specific for Math function mode

The parameters of **Logical channel** in **Math function** mode should be:

- **Name** - to rename a channel, press the button next to the Name label, and then set any name,
- **Unit** - to create a unit use the **Scaling** parameter (more information see **Chapter 7.8.1. Logical Channels - general settings**),
- **Mode=Math function**,
- **Function** - this parameter allow user to select math function from the list, for more information see below in this **Chapter**,
- **Latch** parameter block - allows user to set the **latch function** which will hold the last value of a channel (discussed in **Chapter 7.8.1. Logical Channels - general settings**),
- **Processing** parameter block - is used for scaling and filtering of data (discussed in **Chapter 7.8.1. Logical Channels - general settings**)
- Displaying parameter block - for these parameters the user select the format and range of data displayed on the screen (discussed in **Chapter 7.8.1. Logical Channels - general settings**),

Function parameter in the **Math function** mode.

Basic math functions implemented into device are: addition, subtraction, multiplication and division. The unit allows the operations of logic functions, trigonometric, array operations, determining the arithmetic mean, finding maximum and minimum values, and many other function that are discussed in the table below. After pressing the button next to the **Function** label go to a math function menu. This menu consists of the following parameters (Note! Not all parameters are available for each function):

- **Function** - available for all math functions, by pressing the button next to the **Function** label a list of available math functions appears, from which we can select the appropriate function,
- **Source X** - available for all math functions, select logical channel or group of logical channels designated as '**X**' for math functions,
- **X error handling** - available for some math functions, depending on this parameter, the user can:
 - **errors forwarded to result** - when the result of the selected channel (**Source X**) is a state: **Error**, **Hi**, **Lo**, or undefined then the output received states: Err, Hi, Lo,
 - **skip erroneous channels** - means, that these channels, which result in a status of **Error**, **Hi**, **Lo** are ignored in the calculation of selected math function,
- **Type of source Y** - available for certain math functions. Available types are:
 - **channel** - meaning that the '**Y**' source will be a logical channel selected from a list in **Source Y** parameter,
 - **value** - means that the '**Y**' source will be a constant value entered in the **Source Y** parameter,
- **Source Y** - available for certain math functions. Depends of **Type of source Y** parameter. This parameter allows user to:
 - select logical channel from list,
 - or enter set point value (**Type of source Y=value**),
- **Unit** - available for certain trigonometric functions. Allow an option to be selected:
 - **degree**
 - **radian**

Example of configuration of logical channel in **Math function** mode

Steps to configure the function which summarizing values of logical channels: 1, 3, 4, 5 are shown in Fig. 7.47. If any logical channel has **Error** state or value exceeds the range of a logical channel (Hi, Lo) then output has the same state. The following steps are:

- (1) - Select **Math function** mode in the appropriate logical channel (e.g. 14). Press the button next to the **Function** label to enter the **Function** menu,
- (2) - Enter the **Function** sub-menu by pressing the button next to the **Function** label,
- (3) - Choose function from the list, in this case: **Sum X[i]**,
- (4) - Choose the appropriate source '**X**' by pressing the button next to **Source X** label,
- (5) - Choose logical channel from a list, in this case **1, 3, 4, 5**,
- (6) - Set the **X error handling** parameter to **errors forwarded to result**,
- (7) - If the function is configured correctly, we should get a description of function next to the **Function** label: **Sum [1,3,4,5]**.

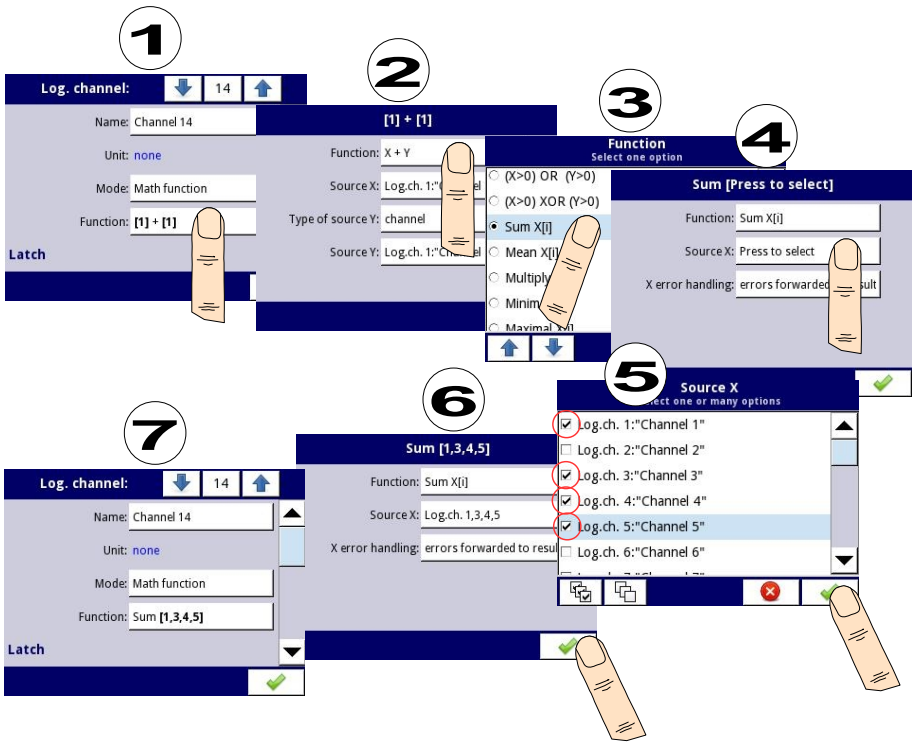

Fig. 7.47. Sample configuration of logical channel in **Math function** mode

Explanation of the table:



Scaling of logical functions.

In the device the values of logical channel ≤ 0 are interpreted as a '0' logic, and the values of logical channel > 0 as a '1' logic.

Math function	Description	Example
X+Y	The sum of two channel or channel and constant value ¹	[1] + [2] – The sum of channel 1 and 2
X-Y	The subtraction of two channels or channel and a constant value ¹	[1] - [2] – The subtraction of channel 1 and 2
X/Y	The ratio of two channels or channel and a constant value ¹	[1] / [2] – The ratio of the channel 1 to channel 2
X*Y	The product of two channel or channel and a constant value ¹	[1] * [2] – The product of channel 1 and channel 2

(X>0) AND (Y>0)	Logical AND	[1] AND [2] - result = 1, when the value of channel 1 and 2 is greater than 0
(X>0) OR (Y>0)	Logical OR	[1] OR [2] – result = 1, when the value of channel 1 or/and 2 is greater than 0
(X>0) XOR (Y>0)	Logical XOR	[1] XOR [2] – result = 1, when the value of the one channel is greater than 0 and the value of second channel is ≤ 0 . When both channels have values ≤ 0 or when both channels have values >0 then the result is 0.
SUM X[i]	The sum of selected channels	SUM[1,2,3,4] – the result is the sum of channels 1, 2, 3, 4
MEAN X[i]	The mean value of the selected channels.	MEAN[1,2,3,4] – the result is the arithmetic mean value of channels 1, 2, 3, 4
MULT X[i]	The product of the value of the selected channels.	MULT[1,2,3,4] - the result is the product of channels 1, 2, 3, 4
MIN X[i]	The smallest value of selected value of the selected channels	MIN[1,2,3,4] - the result is lowest value of the selected channels 1, 2, 3, 4
MAX X[i]	The largest value of selected value of the selected channels	MAX[1,2,3,4] - the result is highest value of the selected channels 1, 2, 3, 4
ANY X[i]>Y	The result = 1 if the value of any set of selected channels is greater than the value of the channel or constant value Y	ANY[1,2,3,4]>[5] – if the value of any set of channel 1, 2, 3, 4 is greater than the value of the channel 5 then the result is 1, otherwise it will be 0
ALL X[i]>Y	The result = 1 if all values of selected channels are greater than the value of the channel or constant value Y	ALL[1,2,3,4]>[5] – the result is 1 if all values of channels 1, 2, 3, 4 are greater than the value of the channel 5
ANY X[i]<Y	The result = 1 if the value of any set of selected channels is less than the value of the channel or constant value Y	ANY[1,2,3,4]<[5] - if the value of any set of channel 1, 2, 3, 4 is less than the value of the channel 5 then the result is 1, otherwise it will be 0

ALL X[i]<Y	The result = 1 if all values of selected channels are smaller than the value of the channel or constant value Y	ALL[1,2,3,4]>[5] – the result is 1 if all values of channels 1, 2, 3, 4 are less than the value of the channel 5
X[i] selected by Y	The result is a value of channel from list of channel X which selected by the value of channel Y	[1,2,3,4]selected by[5] - by the value of the channel 5 is selected appropriate value from channels 1, 2, 3, 4 (for value ≤ 0 of channel 5 will be selected value of channel 1; for value (0,1> of channel 5 -> value of channel 2; for value (1,2> of channel 5 -> value of channel 3; for value >2 of channel 5 -> value of channel 4). (see the <i>Example 7.8.10.7, Chapter 7.8.10</i>)
sin(X)	Sine value of the selected channel	sin([17]) - sine value of channel 17
arcsin(X)	Arcsine value of the selected channel	arcsin([8]) - arcsine value of channel 8
cos(X)	Cosine value of the selected channel	cos([4]) - cosine value of channel 4
arccos(X)	Arccosine value of the selected channel	arccos([1]) - arccosine value of channel 1
tan(X)	Tangent value of the selected channel	tan([2]) - tangent value of channel 2
arctan(X)	Arctangent value of the selected channel	arctan([4]) - arctangent value of channel 4
cot(X)	Cotangent value of the selected channel	cot([10]) - cotangent value of channel 10
arccot(X)	Arccotangent value of the selected channel	arccot([3]) - arccotangent value of channel 3
X^Y	Exponentiation - involving two numbers, the base X (value of selected channel) and the exponent Y (value of selected channel or set point value) ¹	[1]^[2] - value of channel 1 to power to value of channel 2
log_Y(X)	Logarithm of selected channel X with respect to base Y (value of selected channel or set point value) ¹	log_[2]([4]) - logarithm of channel 4 with respect to base of channel 2

min(X) reset by Y	minimal value of selected channel X if value of channel Y ≤ 0, or current value of X (reset) if value of Y > 0	min([1]) reset by [4] - minimal value of channel 1 reset by channel 4
max(X) reset by Y	maximal value of selected channel X if value of channel Y ≤ 0, or current value of X (reset) if value of Y > 0	max([1]) reset by [4] - maximal value of channel 1 reset by channel 4

¹ the method of selecting logical channel or set point value is shown in Fig. 7.48

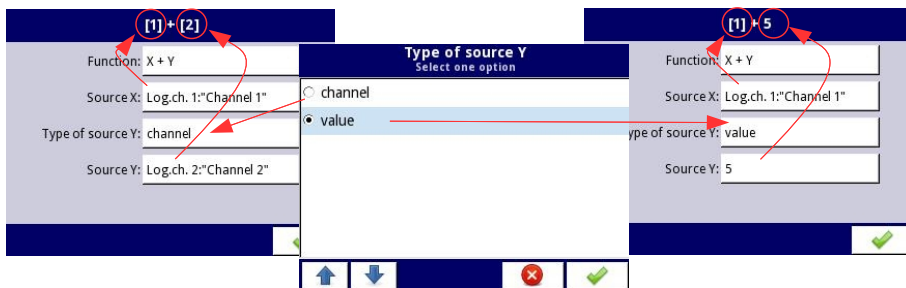
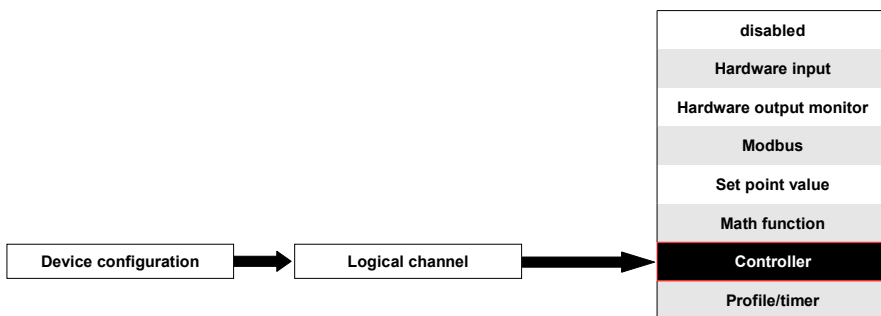

Fig. 7.48. The method of selecting a **channel** or a **set point value** for the **Source Y**

7.8.7. Logical Channels settings for Controller mode



This mode allows the user to set up the PID control loop which may control the objects. To create **controlling process** the **Logical Channel** should be set in **Controller** mode as in Fig. 7.49.

Fig. 7.49. Input channel configuration in Controller mode

To the parameters of **Logical channel** in **Controller** mode should be:

- **Name** - to rename a channel, press the button next to the Name label, and then set any name,
- **Mode=Controller** - in this parameter user selects source of data for logical channel,
- **Unit** - this parameter allows the user to define the unit,
- **Controller number** - this parameter allows the user to select a controller from the list (1÷8). Before selecting or after selecting the controller from the list inside the Logical channel, user must configure the selected controller in the **Controllers** menu (overview and configuration parameters that define the controllers can be found in **Chapter 7.12. CONTROLLERS**).
- **Set point channel** - this parameter allows the user to select a logical channel with set point value (see Fig. 7.50), **Set point channel** defines input data for process control,
- **Feedback channel** - this parameter allow the user to select a channel with data returned from control system (see Fig. 7.50), **Feedback channel** define input data for process control,

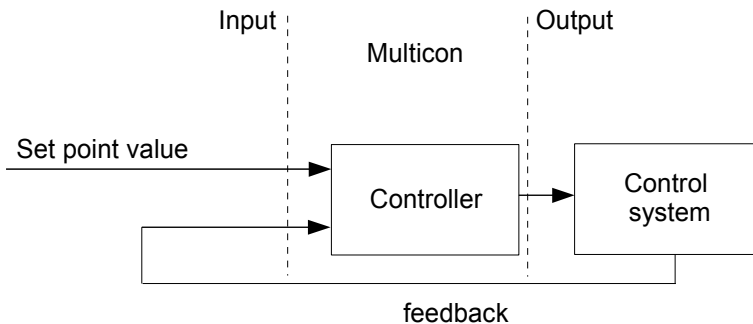

Fig. 7.50. The overall structure of control system implemented in the device

- **Latch** parameter block - allows user to set the **latch function** which will hold the last value of a channel (discussed in **Chapter 7.8.1. Logical Channels - general**

- **settings**),
- **Processing** parameter block - is used for scaling and filtering data (discussed in **Chapter 7.8.1. Logical Channels - general settings**)
- **Displaying** parameter block - for these parameters the user select format and range of data displayed on the screen (discussed in **Chapter 7.8.1. Logical Channels - general settings**).



User must configure the controller parameters in the **Controllers** menu before using this controller to control real object (see **Chapter 7.12. CONTROLLERS**).

To read more about **Controllers profiles** see **Chapter 7.12. CONTROLLERS**.

7.8.8. Logical Channels settings for Profile/timer mode

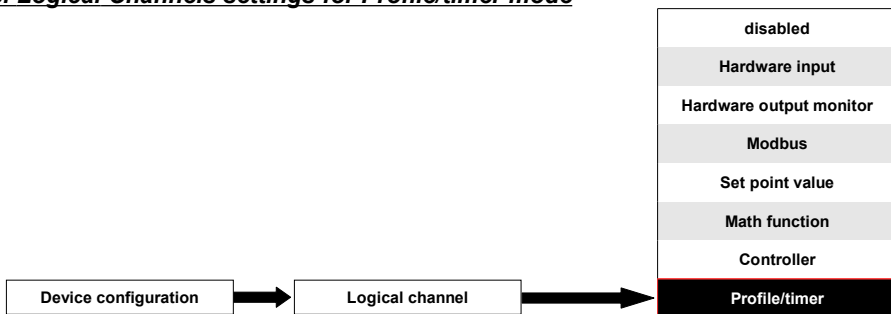

This mode allows the user to set up appropriate Profile/timer defined in **Profiles/timers** menu which may generate signal defined by the user to control any process. To create **Profile/timer** the **Logical Channel** should be set in **Profile/timer** mode as in Fig. 7.49.



Fig. 7.51. View of the input channel configuration in Profile/timer mode

The parameters of the **Logical channel** in **Profile/timer** mode should be:

- **Name** - to rename a channel, press the button next to the Name label, and then set any name,
- **Unit** - to create unit use the **Scaling** parameter (for more information see **Chapter 7.8.1. Logical Channels - general settings**),

- **Mode=Profile/timer** - in this parameter user selects source of data for logical channel,
- **Source** - this parameter allows the user to select a Profile/timer from the list (**8 Profiles/timers** are implemented in the device), which selected option will be data source for this logical channel. Before selecting or after selecting the **Profile/timer** from the list inside the Logical channel, the user must configure the selected Profile/timer pressing the **Configure source** button or enter into the **Profiles/timers** menu (overview and configuration parameters that define the Profiles/timers can be found in **Chapter 7.11. PROFILES/TIMERS**),
- **Configure source** - this button allows the user to configure **Profile/timer** selected in the **Source** parameter. For more information see below in this **Chapter**,
- **Latch** parameter block - allows the user to set the **latch function** which will hold the last value of a channel (discussed in **Chapter 7.8.1. Logical Channels - general settings**),
- **Processing** parameter block - is used for scaling and filtering data (discussed in **Chapter 7.8.1. Logical Channels - general settings**)
- **Displaying** parameter block - for these parameters the user select format and range of data displayed on the screen (discussed in **Chapter 7.8.1. Logical Channels - general settings**),

Configure source button in **Profile/timer** menu

There are two methods for configuring Profiles/timers:

- by the **Profiles/timers** menu, following steps: **MAIN->Device configuration->Profiles/timers** (see **Chapter 7.11. PROFILES/TIMERS**),
- directly in the **Logical channel** in **Profile/timer** mode by pressing the **Configure source** button.

View of window of configuration the profile/timer in both cases is the same. Overview of setting profile/timer is presented in **Chapter 7.11. PROFILES/TIMERS**.

7.8.9. Logical Channels for Profile/timer (cycle counter) mode

This mode is similar to **Profile/timer** mode but instead of signal value generated by Profile/timer, number of cycles released by profile is transferred to logical channel.

7.8.10. Examples of Logical Channels configuration

*Example 7.8.10.1: Application of input channel in the Hardware input mode for UI4 module (see the **Appendix 8.2 UI4, UI8, UI16, UI16, FI4 - VOLTAGE, CURRENT AND FLOW MEASUREMENT MODULES**) and Math function mode*

Task:

This example shows how to measure voltage and current and calculate a power consumption of the heater. Voltage, current and power of the heater must be display in one window in needle dials mode. Additional in this example user must use external converters to measure voltage and current exceed the range of **UI4** input module.

Solution:

Before configure the device, connect the heater to converters and then to the device (in accordance with Fig. 7.52).

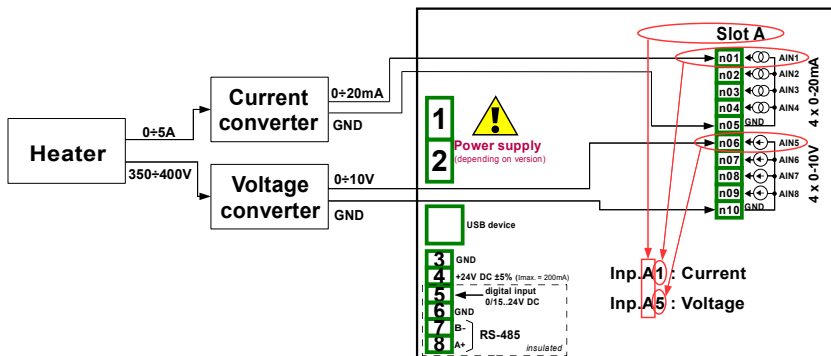

Fig. 7.52. Schematic diagram for the UI4 module

In the next step you need to define three logical channels: for current, voltage and power. To do this:

a) For a current,

- touch screen and press the **Menu** button, then press the **Device configuration** button and enter the **Input channels** menu,
- using the arrows in the top navigation bar, select any **logical channel** such as 20, change the name to "**Current**" and set the **Hardware input** mode,
- choose as the source - **Inp. A1: Current** (see the connection in Fig. 7.52), press the **Source configuration** button to set the source configuration options,
 - The **Mode** set to **0-20mA** current range, because this current range it comes from current converter,
 - the **Low Limit** parameter is set to **0mA**,
 - the **High Limit** parameter is set to **20mA**, the parameters of the **High** and **Low limit**, restrict the range of the input module (total range for the current input is $0 \div 22mA$), beyond which the display displays the value of properly **-Lo-** and **-Hi-**. After setting the source configuration parameters must approve the changes and exit from the sub-menu,
- it is also necessary in this example, setting the scaling of the input signal (with values 0 to 20mA current input given on the current converter to the value 0 to 5A of heater), to do this in a **Processing** block parameters set **Scale=linear**, press **Configure scaling**,
 - set the **Output unit=A**, in the **Point 1** section set **Input value: 0mA**, **Output value: 0A**, in the **Point 2** section set the **Input value: 20mA**, **Output value: 5A**, then exit this sub-menu,
- Set the Display block parameters,
 - The **numeric** display format,
 - **Precision: 0.0** (the value to be displayed with one decimal place),
 - The **Graph low** set to **0A**, the **Graph high: 5A**, these parameters limit the range of the swing-needle in needle dials mode,

b) For a voltage,

- using the arrows in the top navigation bar, select any **logical channel** such as 21, change the name to "**Voltage**", and set the **Hardware input** mode,
- choose as the source - **Inp. A5: Voltage** (see the connection in Fig. 7.52), press the

Source configuration button to set the source configuration options,

- The **Mode** set to **0-10V** voltage range, because this voltage range it comes from voltage converter,
- the **Low Limit** parameter is set to **0V**,
- the **High Limit** parameter is set to **10V**, the parameters of the **High** and **Low limit**, restrict the range of the input module (total range for the voltage input is $0 \div 12V$), beyond which the display displays the value of properly **-Lo-** and **-Hi-**. After setting the source configuration parameters must approve the changes and exit from the sub-menu,
- it is also necessary in this example, setting the scaling of the input signal (with values 0 to 10V voltage input given on the voltage converter to the value 0 to 400V of heater), to do this in a **Processing** block parameters set **Scale=linear**, press **Configure scaling**,
 - set the **Output unit=V**, in the **Point 1** section set **Input value: 0V**, **Output value: 0V**, in the **Point 2** section set the **Input value: 10V**, **Output value: 400V**, then exit this sub-menu,
- Set the **Displaying** block parameters,
 - The **numeric** display format,
 - **Precision: 0.0** (the value to be displayed with one decimal place),
- The **Graph low** set to **0V**, the **Graph high: 400V**, these parameters limit the range of the swing-needle in needle dials mode,

c) For a power,

- using the arrows in the top navigation bar, select any **logical channel** such as 22, change the name to **"Power"**, and set the **Math function** mode,
- press the button next to the **"Function"** label to select the appropriate function that allows the calculation of the heater power $P = I * U$,
 - in the **Function** menu press the **Function** parameter and select the function **X * Y**,
 - in the **Source X** parameter select logical channel 20, which defined as a reading of the heater current,
 - In the **Type of source Y** parameter select **channel**, because we want to multiply two logical channels in order to calculate the heater power,
 - in the **Source Y** parameter select logical channel 21, which is defined as reading of the heater voltage, next exit from this sub-menu,
 - set the power scaling (use kW for better readability), to do this in a **Processing** block parameters set **Scale=linear**, press **Configure scaling**,
 - set the **Output unit=kW**, in the **Point 1** section set **Input value: 0**, **Output value: 0kW**, in the **Point 2** section set the **Input value: 1000**, **Output value: 1kW**, then exit this sub-menu,
- Set the **Displaying** block parameters,
 - The **numeric** display format,
 - **Precision: 0.00** (the value to be displayed with two decimal places),
 - The **Graph low** set to **0kW**, the **Graph high: 2kW**, these parameters limit the range of the swing-needle in needle dials mode,
- exit from **Input channels** menu,

In the next step you need to define **Group** the set up logical channels to view them in one window on the screen. To do this:

- enter the **Group** menu, to enable the **Group 1** if it is off, then go to the **Display**

options block parameters,

- in the **Name** parameter change a name to the **Heater**, the other parameters of this block is left to default (**Charts**, **Bars**, **Line width**, **Time scale**, **Background**) because they are not related to the **needle** display mode, go to the **Channels** block parameters,
- in the **Channels** block parameters we set,
 - in the **Slot 1** parameter select a logical channel 22 called the **Power**,
 - in the **Slot 2** parameter select a logical channel 21 called the **Voltage**,
 - in the **Slot 3** parameter select a logical channel 20 called the **Current**,
 - other parameters in this block - **Slot 4, 5, 6**, set as disabled, because we want to show only three logical channels,
- in the **Logging options** block parameters (this block of parameters appear if you have license for logging) set mode to disabled (do not want to record the data from this group of logical channels), exit from the **Group** menu,
-

The last step is to define the initial view displayed on the LCD screen when you start the device. Initial View has to display a defined group of logical channels: power, voltage and current in-needle mode. To do this:

- enter in the **General settings** menu, **Basic** block parameters left unchanged unless indicated date and time were to set incorrectly and should be improved,
- in the **LCD screen** block parameters in the **backlight** set the parameter to a value corresponding to the user, for example, the value of 80%,
- the **Screen saver** block parameters set to disabled mode, as in this example we want to display all the time **Backlight** with the same clarity 80%,
- in the **Initial view** block parameters set the initial view,
 - **Display mode** parameter set to **needle** dials,
 - **Displayed group** parameter set to **Group 1: Heater**,
- the **Automatic view change** block parameters set to disabled, as in this example we want to all the time displayed only **Group 1** in the same needle mode, after setting all parameters exit the **General settings** menu,

Ultimately, you must exit the menu by pressing the **Save changes** button. The result of the changes should be visible after a call to the first measurement and manual switch for displaying Group 1. Example of a window view for 3 logical channels is shown in Fig. 7.53.

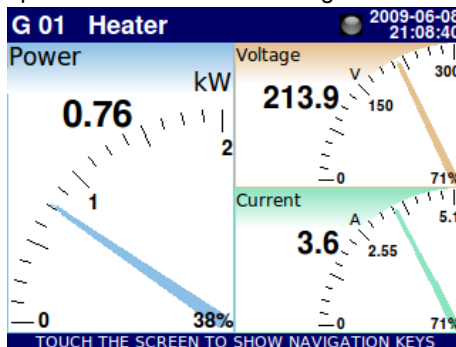

Fig. 7.53. **Logical channels** configuration - Example 1

Example 7.8.10.2: Application of input channel in the **Hardware input mode** for **tc4** modules (see the **Appendix 8.3TC4, TC8 – THERMOCOUPLE SENSOR MEASUREMENT MODULES**) and **Math function mode**.

Task:

The task is to measure the four temperatures in the production hall by using a thermocouple K type. If all temperatures are greater than the preset value of 140 °C, in a separate channel (alarm condition) is to display the inscription: **-HI-**, in other cases is displayed **-LO-**. All logical channels and a channel with a temperature alarm condition will be displayed in one window in values mode.

Solution:

Before measuring temperature the thermocouple sensors should be connected to the device. An example of how the connection is shown in Fig. 7.54 (see also **Appendix 8.3TC4, TC8 – THERMOCOUPLE SENSOR MEASUREMENT MODULES**).

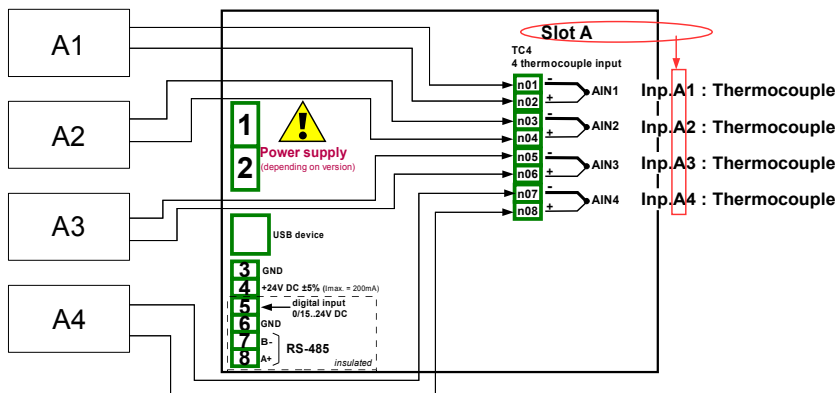

Fig. 7.54. Schematic diagram for the **TC4** module

In the next step you need to define five logical channels respectively for four temperatures in the hall of the symbols A1, A2, A3, A4, and an temperature alarm condition. To do this:

a) For the temperature reading of sensor 1 with the symbol A1:

- touch screen and press the **Menu** button, then press the **Device configuration** button and enter the **Input channels** menu,
- using the arrows in the top navigation bar, select any **logical channel** such as 1, change the name to **"Temperature A1"** and set the **Hardware input mode**,
- choose as the source - **Inp. A1: Thermocouple** (see the connection in Fig. 7.54), press the **Source configuration** button to set the source configuration options,
 - The **Mode** set to **Thermocouple K**,
 - the **Low Limit** parameter is set to **-200°C**,
 - the **High Limit** parameter is set to **1370°C**, the parameters of the **High and Low limit**, restrict the range of the input module (total range for the **thermocouple K** is **-200 ÷ 1370°C**), beyond which the display displays the value of properly **-Lo-** and **-Hi-**. After setting the source configuration parameters must approve the changes and exit from the sub-menu,
- because it is not necessary or scaling, or filter data then the parameters in

Processing block as disabled,

- Set the **Display** block parameters,
 - The **numeric** display format,
 - **Precision**: 0, because this precision is enough to control the temperature of the Hall,
 - The Graph low set to **-200°C**, the Graph high: **1370°C**, these parameters limit the range of percentage values in value mode.

b) For the temperature reading of sensor 2 with the symbol A2:

Proceed the same as for sensor 1, except that:

- Using the arrows in the top navigation bar, select any logical channel (except for 1) for example 2, change the name to "**Temperature A2**", and set the **hardware input** mode, with the **Source - Inp. A2: Thermocouple**

Other parameters are set as the sensor 1.

c) For the temperature reading of sensor 3 with the symbol A3:

Proceed the same as for sensor 1, except that:

- Using the arrows in the top navigation bar, select any logical channel (except for 1 and 2) for example 3, change the name to "**Temperature A3**", and set the **hardware input** mode, with the **Source - Inp. A3: Thermocouple**

Other parameters are set as the sensor 1.

d) For the temperature reading of sensor 4 with the symbol A4:

Proceed the same as for sensor 1, except that:

- Using the arrows in the top navigation bar, select any logical channel (except for 1, 2 and 3) for example 4, change the name to "**Temperature A4**", and set the **hardware input** mode, with the **Source - Inp. A4: Thermocouple**

Other parameters are set as the sensor 1.

e) For alarm state,

- using the arrows in the top navigation bar, select any logical channel (except for 1, 2, 3 and 4) eg 5, change the name to "**Alarm**" and set the **Math function** mode,
- press the button next to the "**Function**" label to select the appropriate function that allows the calculation alarm condition,
 - in the **Function** menu press the **Function** parameter and select the function **All X[i] > Y**,
 - in the **Source X** parameter select logical channels 1, 2, 3, 4 which we defined as a measure of temperature,
 - In the **Type of source Y** parameter select **value**, because we want to compare the measure values with constant value 140°C,
 - in the **Source Y** parameter set value 140, next exit from this sub-menu,
- because it is not necessary or scaling, or filter data then the parameters in **Processing** block as disabled,
- Set the **Displaying** block parameters,
 - The **binary** display format, because we would to display states: **LO** and **HI**,
 - set Off-state text to **LO** with blue font colour,
 - set On-state text to **HI** with red font colour,
 - The **Graph low** set to **0**, the **Graph high**: **1**, these parameters limit the range of the (the value of the alarm switches between 0 and 1), these parameters limit the range of percentage values in value mode,
- exit from **Input channels** menu,

In the next step you need to define **Group** the set up logical channels to view them in one window on the screen. To do this:

- enter the **Group** menu, to enable the **Group 1** if it is off, then go to the **Display options** block parameters,
 - in the **Name** parameter change a name to the “**Temp.Measurment**”, the other parameters of this block is left to default (**Charts, Bars, Line width, Time scale, Background**) because they are not related to the **value** display mode, go to the **Channels** block parameters,
 - in the **Channels** block parameters we set,
 - in the **Slot 1** parameter select a logical channel 1 called the **Temperature A1**,
 - in the **Slot 2** parameter select a logical channel 2 called the **Temperature A1**,
 - in the **Slot 3** parameter select a logical channel 3 called the **Temperature A1**,
 - in the **Slot 4** parameter select a logical channel 4 called the **Temperature A4**,
 - in the **Slot 5** parameter select a logical channel 5 called the **Alarm state**,
 - last parameter in this block - **Slot 6**, set as disabled, because we want to show only 5 logical channels,
 - in the **Logging options** block parameters (this block of parameters appear if you have license for logging) set mode to disabled (do not want to record the data from this group of logical channels), exit from the **Group** menu,

The last step is to define the initial view displayed on the LCD screen when you start the device. Initial View has to display a defined group of logical channels: 1, 2, 3, 4, 5 in value mode. To do this:

- enter in the **General settings** menu, **Basic** block parameters left unchanged unless indicated date and time were to set incorrectly and should be improved,
- in the **LCD screen** block parameters in the **backlight** set the parameter to a value corresponding to the user, for example, the value of 80%,
- the **Screen saver** block parameters set to disabled mode, as in this example we want to display all the time **Backlight** with the same clarity 80%,
- in the **Initial view** block parameters set the initial view,
 - **Display mode** parameter set to **value**,
 - **Displayed group** parameter set to **Group 1: Temp.Measurment**,
- the **Automatic view change** block parameters set to disabled, as in this example we want to all the time displayed only **Group 1** in the same value mode, after setting all parameters exit the **General settings** menu,

Ultimately, you must exit the menu by pressing the **Save changes** button. The result of the changes should be visible after a call to the first measurement and manual switch for displaying Group 1. Example of a window view for 5 logical channels is shown in Fig. 7.53.

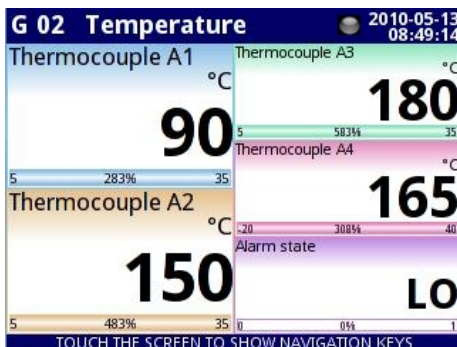

Fig. 7.55. The proposition of the result the Example 2

Example 7.8.10.3: Application of input channel in the Hardware input mode for RT4 modules (see the Appendix 8.4 RT4 – RTD MEASUREMENT MODULE).

Task:

The MultiCon with built-in RT4 module can measure simultaneously temperature at four points. Suppose you want to monitor the temperature in the basement, kitchen, bathroom and outside the home. To monitor the temperature in the first two channels, we will use the PT1000 sensors and connections 3-wire, and for the rest of PT100 and connections 2 and 4-wire. We would to read the temperature from 4 sensors in one window in vertical bars mode. In addition, we want to log temperature every 1 minute.

Solution:

First, connect the sensors as shown in Figure 7.60 (see Appendix 8.4. RT4 - RTD measurement module). After entering the configuration of the physical inputs can be configured in the Channel 4 channels input logic.

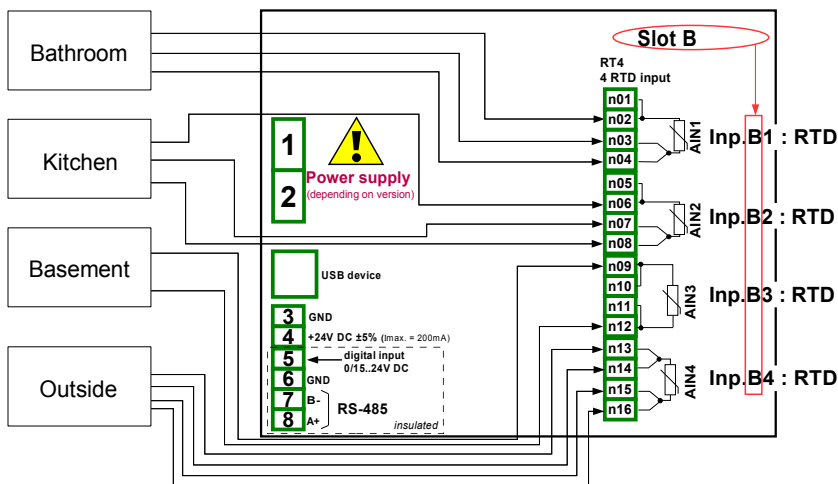

Fig. 7.56. Schematic diagram for the RT4 module

To read the temperature from sensor 1 (Bathroom):

- touch screen and press the **Menu** button, then press the **Device configuration** button and enter the **Input channels** menu,
- using the arrows in the top navigation bar, select any **logical channel** such as 32, change the name to "**Bathroom**" and set the **Hardware input** mode,
- choose as the source - **Inp. B1: RTD** (see the connection in Fig. 7.56), press the **Source configuration** button to set the source configuration options,
 - The **Mode** set to **Pt1000 3-wire**,
 - the **Low Limit** parameter is set to **-100°C**,
 - the **High Limit** parameter is set to **600°C**, the parameters of the **High** and **Low limit**, restrict the range of the input module (total range for the **thermocouple K** is **-100 ÷ 600°C**), beyond which the display displays the value of properly **-Lo-** and **-Hi-**. After setting the source configuration parameters must approve the changes and exit from the sub-menu,
- because it is not necessary or scaling, or filter data then the parameters in **Processing** block as disabled,
- Set the **Display** block parameters,
 - The **numeric** display format,
 - **Precision**: 0.0, because this precision is good for precision of Pt1000 sensor connected to the **RT4** module,
 - The **Graph low** set to **15°C**, the **Graph high**: **30°C**, these parameters limit the range of bar indicator in bars mode. Assumed that in the bathroom does not appear the temperature below 15 ° C or higher and 30 ° C.

Other channels set in the same way (logical channel 31: "**Kitchen**", logical channel 30: "**Basement**", logical channel 33: "**Outside**"). For sensor 3 (**Basement**) and sensor 4 (**Outside**) in the **Source configuration** sub-menu is appropriately select **PT100**.

In the next step you need to define **Group** the set up logical channels to view them in one window on the screen. To do this:

- enter the **Group** menu, to enable the e.g. **Group 2** if it is off, then go to the **Display options** block parameters,
 - in the **Name** parameter change a name to the "**Home**", next we set:
 - **Bars=vertical** (the remaining parameters of this block is left to default (**Charts**, **Line width**, **Time scale**, **Background**, because they are not associated with the bars display mode), next go to the **Channels** block parameters,
 - in the **Channels** block parameters we set,
 - in the **Slot 1** parameter select a logical channel 32 called the **Bathroom**,
 - in the **Slot 2** parameter select a logical channel 31 called the **Kitchen**,
 - in the **Slot 3** parameter select empty,
 - in the **Slot 4** parameter select a logical channel 30 called the **Basement**,
 - in the **Slot 5** parameter select a logical channel 33 called the **Outside**,
 - in the **Slot 6** parameter select empty,
 - in the **Logging options** block parameters (this block of parameters appear if you have license for logging) we set
 - **Mode=always**, we want to register at all times until the we change the configuration to stop the registration,
 - **logging description: measure of House temperature**, (it can be any text),
 - **Period=1 min.**,

- **Unit=minutes**, sampling a group of channels at 1 minute,
- **Alternative mode=disabled**,
- exit from the **Group** menu,

The last step is to define the initial view displayed on the LCD screen when you start the device. Initial View has to display a defined group of logical channels: 32, 31, 30, 33 in bars mode. To do this:

- enter in the **General settings** menu, **Basic** block parameters left unchanged unless indicated date and time were to set incorrectly and should be improved,
- in the **LCD screen** block parameters in the **backlight** set the parameter to a value corresponding to the user, for example, the value of 80%,
- the **Screen saver** block parameters set to disabled mode, as in this example we want to display all the time **Backlight** with the same clarity 80%,
- in the **Initial view** block parameters set the initial view,
 - **Display mode** parameter set to **bars**,
 - **Displayed group** parameter set to **Group 2: Home**,
- the **Automatic view change** block parameters set to disabled, as in this example we want to all the time displayed only **Group 2** in the same bars mode, after setting all parameters exit the **General settings** menu,

Ultimately, you must exit the menu by pressing the **Save changes** button. The result of the changes should be visible after a call to the first measurement and manual switch for displaying Group 2. Example of a window view for 4 logical channels is shown in Fig. 7.57.

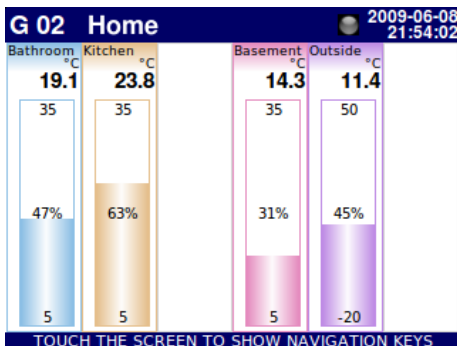

Fig. 7.57. Logical channels configuration - Example 3

Example 7.8.10.4: Application of input channel in the Hardware output monitor mode for **r45**, **r81** modules (see the **Appendix 8.9 R45, R81 - RELAY MODULES**).

Task:

This example shows how to read the value from output module **r45**.

Solution:

First, connect the relay as shown in Fig. 7.58 (see **Appendix 8.7. R45, R81-relay modules**). After setting the configuration of the physical inputs can configure the input channel to read the output value.

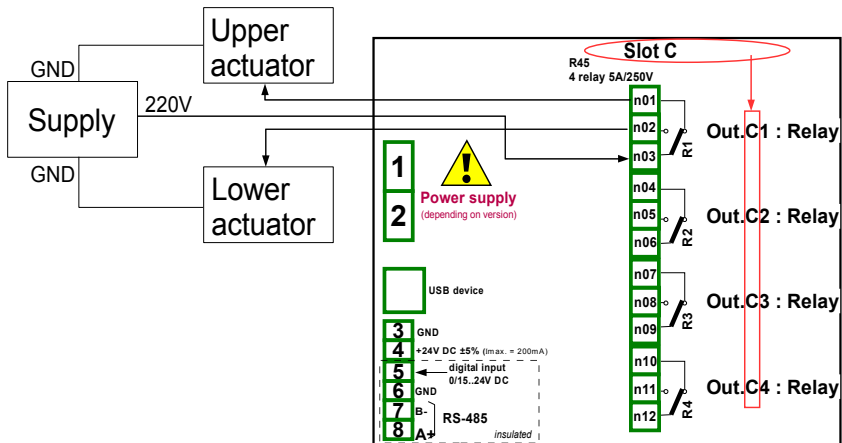

Fig. 7.58. Schematic diagram for the R45 module

To read the output value from module should be:

- touch screen and press the Menu button, then press the **Device configuration** button and enter the Input channels menu,
- using the arrows in the top navigation bar, select any **logical channel** such as 5, change the name to "**Relay 1**" and set the **Hardware output monitor** mode,
- choose as the source - **Out. C1: Relay** (see the connection in Fig. 7.58),
- because it is not necessary or scaling, or filter data then the parameters in **Processing** block as disabled,
- Set the **Displaying** block parameters,
 - The **binary** display format, because we would to display states: **OFF** and **ON**,
 - set **Off-state text** to **OFF** with red font colour and yellow background,
 - set **On-state text** to **HI** with green font colour and violet background,
 - The **Graph low** set to **0**, the **Graph high**: **1**, these parameters limit the range of the percentage indicator in values mode (for low relay state is 0 for high relay state is 1),
- exit from **Input channels** menu,

In the next step you need to define **Group** the set up logical channels to view them in one window on the screen. To do this:

- enter the **Group** menu, to enable the **Group 1** if it is off, then go to the **Display options** block parameters,
 - in the **Name** parameter change a name to the "**Monitor output**", the other parameters of this block is left to default (**Charts, Bars, Line width, Time scale, Background**) because they are not related to the **values** display mode, go to the **Channels** block parameters,
 - in the **Channels** block parameters we set,
 - in the **Slot 1** parameter select a logical channel 5 called the **Relay 1**,
 - other parameters in this block - **Slot 2, 3, 4, 5, 6**, set as disabled, because we want to show only one logical channel,
 - in the **Logging options** block parameters (this block of parameters appear if

you have license for logging) set mode to disabled (do not want to record the data from this group of logical channels), exit from the **Group** menu,

The last step is to define the initial view displayed on the LCD screen when you start the device. Initial View has to display a defined group of logical channel 1 in **values** mode. To do this:

- enter in the **General settings** menu, **Basic** block parameters left unchanged unless indicated date and time were to set incorrectly and should be improved,
- in the **LCD screen** block parameters in the **backlight** set the parameter to a value corresponding to the user, for example, the value of 80%,
- the **Screen saver** block parameters set to disabled mode, as in this example we want to display all the time **Backlight** with the same clarity 80%,
- in the **Initial view** block parameters set the initial view,
 - **Display mode** parameter set to **value**,
 - **Displayed group** parameter set to **Group 1: Output monitor**,
- the **Automatic view change** block parameters set to disabled, as in this example we want to all the time displayed only **Group 1** in the same value mode, after setting all parameters exit the **General settings** menu,

After whole configuration exit the menu pressing **Save changes**, the result should be visible as soon as first measurement is done. View the window of MultiCon with the above configuration is shown in Fig. 7.59.



Fig. 7.59. The proposition of the result of the Example 4

Example 7.8.10.5: Application of input channel in the Modbus mode.

Task:

The task is to read the temperature of the devices **SLAVE 1** and **2** from the **register 1**, which is assigned a physical address: **'1'** and **'8'**.

Solution:

First, configure the device then connect the SLAVE device as shown in Fig. 7.60.

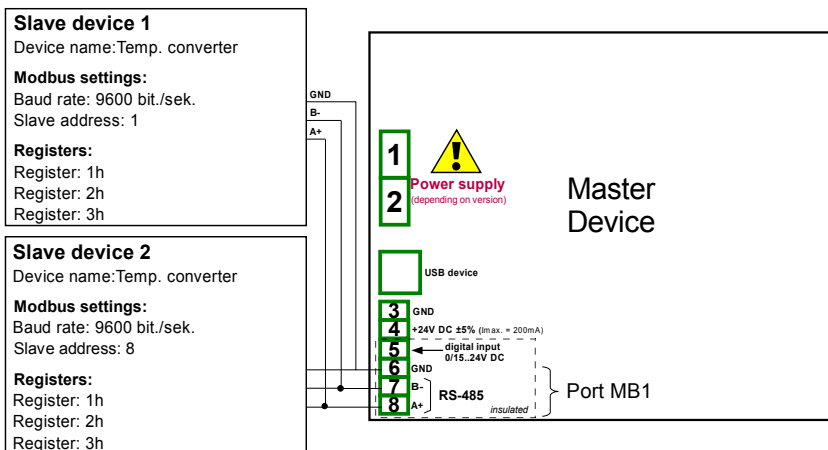

Fig. 7.60. Schematic diagram for SLAVE devices connected to MultiCon

First, configure the Modbus in **Modbus** menu according to Example 7.14.4.1. Then, set the logical channels that reads the register from SLAVE devices. To do this:

- touch screen and press the **Menu** button, then press the **Device configuration** button and enter the **Input channels** menu,
- using the arrows in the top navigation bar, select any **logical channel** such as 1, change the name to **"Temperature 1"** and set the **Modbus** mode,
- select **Port: MB1 (MASTER)**,
- set the **Slave devices** parameter to **Address 1** called **"Temp. converter"**,
- set the **Input device** parameter to **Input 1** a device that reads **Register 1h** from **SLAVE 1** device,
- in this example is not needed either scaling or filtering data, but we want to additionally display the unit so you should in a **Processing** block parameters set **Scale=linear**, and press **Configure scaling**,
 - **Output unit** set to **°C**,
 - in the **Point 1** section set **Input value: 0**, **Output value: 0°C**, in the **Point 2** section set the **Input value: 20**, **Output value: 20°C**, then exit this sub-menu,
- Set the **Display** block parameters,
 - The **numeric** display format,
 - **Precision: 0.0**,
 - The **Graph low** set to **10°C**, the **Graph high: 50°C**, these parameters limit the range of percentage indicator in **values** mode. Assumed that the temperature does not exceed the range **10 ÷ 50°C**.
- next using the arrows in the top navigation bar, select any **logical channel** such as 2, change the name to **"Temperature 2"** and set the **Modbus** mode,
- select **Port: MB1 (MASTER)**,
- set the **Slave devices** parameter to **Address 8** called **"Temp. converter"**,
- set the **Input device** parameter to **Input 2** a device that reads **Register 1h** from **SLAVE 2** device,
- in this example is not needed either scaling or filtering data, but we want to

additionally display the unit so you should in a **Processing** block parameters set **Scale=linear**, and press **Configure scaling**,

- **Output unit** set to °C,
- in the **Point 1** section set **Input value: 0, Output value: 0°C**, in the **Point 2** section set the **Input value: 20, Output value: 20°C**, then exit this sub-menu,
- Set the **Display** block parameters,
 - The **numeric** display format,
 - **Precision: 0.0**,
 - The **Graph low** set to **10°C**, the **Graph high: 50°C**, these parameters limit the range of percentage indicator in **values** mode. Assumed that the temperature does not exceed the range **10 ÷ 50°C**.

In the next step you need to define **Group** the set up logical channels to view them in one window on the screen. To do this:

- enter the **Group** menu, to enable the **Group 1** if it is off, then go to the **Display options** block parameters,
 - in the **Name** parameter change a name to the “**Temperature**”, the other parameters of this block is left to default (**Charts, Bars, Line width, Time scale, Background**) because they are not related to the **values** display mode, go to the **Channels** block parameters,
 - in the **Channels** block parameters we set,
 - in the **Slot 1** parameter select a logical channel 1 called the **Temperature 1**,
 - in the **Slot 2** parameter select a logical channel 2 called the **Temperature 2**,
 - other parameters in this block – **Slot 3, 4, 5, 6**, set as disabled, because we want to show only two logical channels,
 - in the **Logging options** block parameters (this block of parameters appear if you have license for logging) set mode to disabled (do not want to record the data from this group of logical channels), exit from the **Group** menu,

The last step is to define the initial view displayed on the LCD screen when you start the device. Initial View has to display a defined group of logical channels: 1, 2 in **values** mode. To do this:

- enter in the **General settings** menu, **Basic** block parameters left unchanged unless indicated date and time were to set incorrectly and should be improved,
- in the **LCD screen** block parameters in the **backlight** set the parameter to a value corresponding to the user, for example, the value of 80%,
- the **Screen saver** block parameters set to disabled mode, as in this example we want to display all the time **Backlight** with the same clarity 80%,
- in the **Initial view** block parameters set the initial view,
 - **Display mode** parameter set to **values**,
 - **Displayed group** parameter set to **Group 1: Temperature**,
- the **Automatic view change** block parameters set to disabled, as in this example we want to all the time displayed only **Group 1** in the same value mode, after setting all parameters exit the **General settings** menu,

After whole configuration exit the menu pressing **Save changes**, the result should be visible as soon as first measurement is done.

Example 7.8.10.6: Application of input channel in the **Hardware input mode** and **Math function mode** (see **Chapter 7.8.6. Logical Channels settings for Math function mode**).

Task:

In this example we calculate the mean value from logic channels 1, 2, 3, 4, 5, 6, 7 and 8. In these channels are values from thermocouple sensors that are located around the furnace.

Solution:

Before measuring temperature the thermocouple sensors should be connected to the device. An example of how the connection is shown in Fig. 7.61 (see also **Appendix 8.3TC4, TC8 – THERMOCOUPLE SENSOR MEASUREMENT MODULES**).

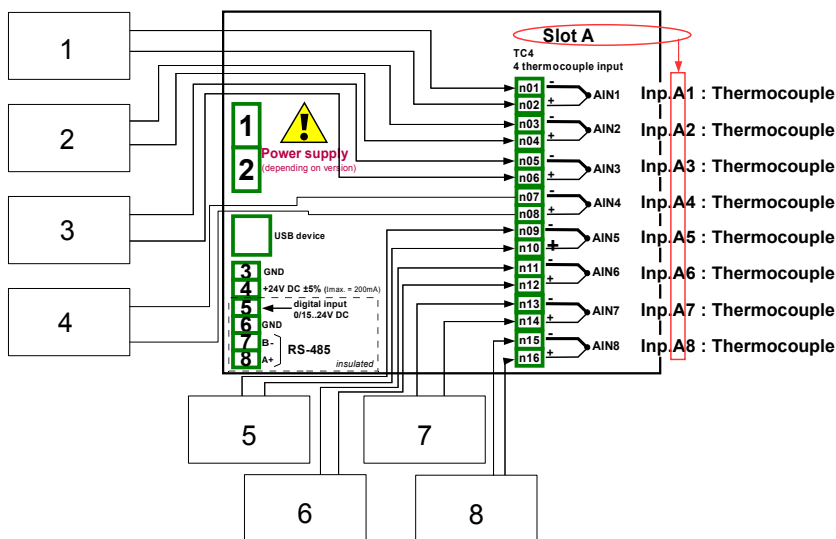

Fig. 7.61. Schematic diagram for the TC8 module

To configure logical channels for reading temperatures from 1-8 inputs (names **Temperature 1**, **Temperature 2**, etc.) should follow the same way as in Example 7.8.10.2.

For Logical channel in **Math function** mode calculated an average value should be:

- using the arrows in the top navigation bar, select any **logical channel** (except 1-8) such as 9, change the name to "**Mean value**", and set the **Math function** mode,
- press the button next to the "**Function**" label to select the appropriate function that allows the calculation of the mean value,
 - in the **Function** menu press the **Function** parameter and select the function **Mean X[i]**,
 - in the **Source X** parameter select logical channel 1 to 8, which defined as a reading of the thermocouples temperature,
 - set **X error handling=errors forwarded to result** - when the result of the selected channel (**Source X**) is a state: **Error**, **Hi**, **Lo**, or undefined then the output received states: **Err**, exit the sub-menu,

- because it is not necessary or scaling, or filter data then the parameters in **Processing** block set as disabled,
- Set the **Displaying** block parameters,
 - The **numeric** display format,
 - **Precision: 0**,
 - the **Graph low** set to **-200°C**, the **Graph high: 1370°C**, these parameters limit the range of percentage indicator in **values** mode.
- exit from **Input channels** menu,

The next step is to define Groups set up logical channels to view them in two windows on the screen. To do this:

- enter the **Group** menu, to enable the **Group 1** if it is off, then go to the **Display options** block parameters,
 - in the **Name** parameter change a name to the **Measure Temp. 1**, the other parameters of this block is left to default (**Charts, Bars, Line width, Time scale, Background**) because they are not related to the **values** display mode, go to the **Channels** block parameters,
 - in the **Channels** block parameters we set,
 - in the **Slot 1** parameter select a logical channel 9 called the **Mean value**,
 - in the **Slot 2** parameter select a logical channel 1 called the **Temperature 1**,
 - in the **Slot 3** parameter select a logical channel 2 called the **Temperature 2**,
 - in the **Slot 4** parameter select a logical channel 3 called the **Temperature 3**
 - in the **Slot 5** parameter select a logical channel 4 called the **Temperature 4**
 - in the **Slot 6** parameter select a logical channel 5 called the **Temperature 5**
 - in the **Logging options** block parameters (this block of parameters appear if you have license for logging) set mode to disabled (do not want to record the data from this group of logical channels), exit from the **Group** menu,
- using the arrows in the top navigation bar, select any **Group** (except 1) such as 2,
 - in the **Name** parameter change a name to the **Measure Temp. 2**, the other parameters of this block is left to default (**Charts, Bars, Line width, Time scale, Background**) because they are not related to the **values** display mode, go to the **Channels** block parameters,
 - in the **Channels** block parameters we set,
 - in the **Slot 1** parameter select a logical channel 6 called the **Temperature 6**,
 - in the **Slot 2** parameter select a logical channel 7 called the **Temperature 7**,
 - in the **Slot 3** parameter select a logical channel 8 called the **Temperature 8**
 - other parameters in this block – **Slot 4, 5, 6**, set as disabled, because we want to show only three logical channels,
 - in the **Logging options** block parameters (this block of parameters appear if you have license for logging) set mode to disabled (do not want to record the data from this group of logical channels), exit from the **Group** menu,

The last step is to define the initial view displayed on the LCD screen when you start the device. **Initial View** has to display a defined group of logical channels in values mode. To do this:

- enter in the **General settings** menu, **Basic** block parameters left unchanged unless indicated date and time were to set incorrectly and should be improved,
- in the **LCD screen** block parameters in the **backlight** set the parameter to a value corresponding to the user, for example, the value of 80%,
- the **Screen saver** block parameters set to disabled mode, as in this example we want to display all the time **Backlight** with the same clarity 80%,
- in the **Initial view** block parameters set the initial view,
 - **Display mode** parameter set to **values** dials,
 - **Displayed group** parameter set to **Group 1: Measure Temp. 1**,
- the **Automatic view change** block parameters set to disabled, as in this example we want to all the time displayed only **Group 1** in the same values mode, after setting all parameters exit the **General settings** menu,

Ultimately, you must exit the menu by pressing the button **Save changes**. The result of the changes should be visible after calling the first measurement. Use [**↓ GROUP**] or [**GROUP ↑**] button in the navigation bar to switch between display groups.

Example 7.8.10.7: Application in **Math function mode** (see **Chapter 7.8.6. Logical Channels settings for Math function mode**).

Task:

Explanation of mathematical functions **X [i] selected by the Y**. The task is to create a logical channel with the function returns a value of logical channel (**X [i]**) selected by the other logical channel (**Y**).

Suppose we have defined four logical channels 1, 5, 8, 12 in **Set point** mode. However, in the logical channel 2 will be the value derived from the temperature sensor. In the logical channel 3 create math function **X [i] selected by the Y**. Using the value of channel 2 we select value from the channels 1, 5, 8, 12.

The result of this function is placed in the following table:

Y value	Value of logical channel 3
$Y \leq 0$	Value of logical channel 1
$0 < Y \leq 1$	Value of logical channel 5
$1 < Y \leq 2$	Value of logical channel 8
$Y > 2$	Value of logical channel 12

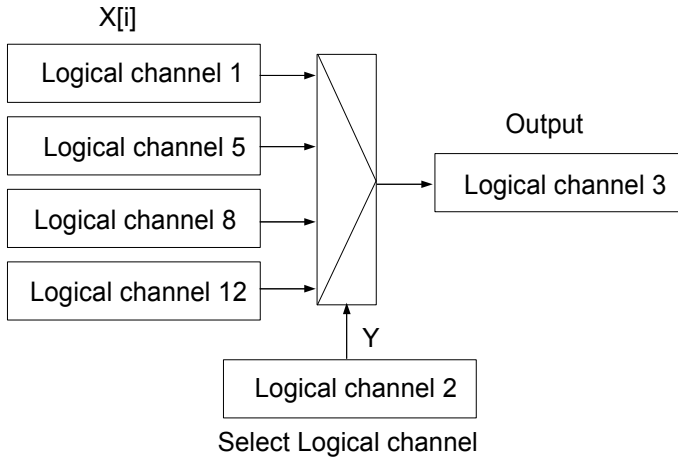

Fig. 7.62. The block diagram of a mathematical function $X [j]$ selected by Y

Solution:

We define a logical channels in **Set point** mode:

- using the arrows in the top navigation bar, select any **logical channel** such as 1, change the name to "**1**", and set the **Set point** mode,
- **Unit** is it not necessary for this example,
- **Set point value** set to e.g. **50**,
- Set the **Displaying** block parameters,
 - The **numeric** display format,
 - **Precision: 0**,
 - the **Graph low** set to **0**, the **Graph high: 80**, these parameters limit the range of percentage indicator in **values** mode.

Other logical channels set the same way (logical channel 5: The name "**5**" set value: **30**, logical channel 8: name "**8**" set value: **80**, logical channel 12: the name "**12**" set value: **5**).

For Logical channel in **Math function** mode you set:

- using the arrows in the top navigation bar, select any **logical channel** such as 3, change the name to "**Function**", and set the **Math function** mode,
- press the button next to the "**Function**" label to select the appropriate function that allows the calculation of the mean value,
 - in the **Function** menu press the **Function** parameter and select the function **$X [j]$ selected by Y** ,
 - in the **Source X** parameter select logical channel **1, 5, 8, 12**,
 - in the **Source Y** parameter select logical channel **2**, exit the sub-menu,
- because it is not necessary or scaling, or filter data then the parameters in **Processing** block set as disabled,
- Set the **Displaying** block parameters,
 - The **numeric** display format,
 - **Precision: 0**,

- the **Graph low** set to **0**, the **Graph high: 80**, these parameters limit the range of percentage indicator in **values** mode.
- exit from **Input channels** menu,

Example 7.8.10.8: Application of input channel in the Controller mode.

Task:

The example is the temperature control that sets point is value of the Logical channel (constant value 85°C) and the feedback signal come from the sensor Pt100.

Solution:

The first step is to configure appropriate parameters for the Controllers menu (sets first Controller its name to "**Controller 1**", see Chapter 7.12 CONTROLLERS and Example 7.12.2.1 to know how to do it).

Next we defined **Logical Channels**. We enter to the **Device configuration** → **Input Channels** menu and using arrows in **upper navigation bar** select **Logical Channel 1**, set its name to "**Value**", and **Mode to Set point value**. The parameter **Unit** sets **°C** and in the **Set point value** parameter we enter a value of **85°C**. Default displaying mode is Format: **Numeric**, and precision: **0**, **Graph Low: 0**, **Graph High: 300**. Next we defined the **Logical channel 2** sets in the **Hardware input** mode and name: "**Sensor**". Assuming that sensor is connected to **Physical Input A1** select this channel as a source. Next press button **Configure source** to enter hardware configuration: we select **Pt100** mode and Low Limit: **50°C** High Limit: **600°C**. Due to we do not need any post processing its both parameters can be disabled (**Scaling: disabled**, **Filter type: disabled**). Default displaying mode is Format: **Numeric**, and precision: **0.0** and it is proper for this purpose, **Graph Low: 0**, **Graph High: 300**. The **Logical channel 3** sets in the **Controller** mode, and name "**Controller**". We set unit: **mA**. The parameter **Controller number** we set the **Controller 1** to defined before, a parameter **Set point channel** we select **Logical channel 1** and parameter **Feedback channel** select **Logical channel 2**. Default displaying mode is Format: **Numeric**, and precision: **0.0** and it is proper for this purpose, **Graph Low: 0 °C**, **Graph High: 20**. We have defined logical channels. Next exit from the menu **Input channels**. To visualise the data, channels must be added to some group. Using **Configuration menu** enter **Groups** definition, and enable **Group 1 (Group: enabled)**. Then change its name to e.g. "**The temperature control**", and select sources of data to be presented. To do this move window over parameters called **Channels** and set them as follow - **Slot 1: Log. ch. 3 "Controller"**, **Slot 2: Log. ch. 1 "Value"**, **Slot 3: Log. ch. 2 "Sensor"**, **Slot 4: disabled**, **Slot 5: disabled**, **Slot 6: disabled**.

After whole configuration exit the menu pressing Save changes, the result should be visible as soon as first measurement is done.

Example 7.8.10.9: Application of input channel in the Profile/timer mode.

Task:

Create the Profile/timer in the logical channel 1 in the edge (once) triggering mode. Trigger source is logical channel 2 is connected to hardware input from voltage/current module UI4. Profile consists of 4 sections: 1. ramp from 0 to 10 in 5 seconds, 2. constant value 8 in 2 seconds, 3. ramp from 8 to 4 in 3 seconds and 4. constant value 4 in 1 seconds. Idle value is 0 and looping is disabled.

Solution:

We enter to the **Device configuration** → **Input Channels** menu and using arrows in upper navigation bar select **Logical Channel 1** and set its mode to **Hardware input** and name **“Triggering”**. Next we can select the current source **Physical Input A1**. - **“Inp. A1: Current”**. Next press button **“Configure source”** to enter hardware configuration. Set mode: Current 0-20mA, Low limit: 0mA, High limit: 20mA and exit hardware configuration menu. Due to we do not need any post processing its both parameters can be disabled (**Scaling: disabled, Filter type: disabled**). Default displaying mode is **Numeric** format, and it is proper for this purpose, but precision and data limits should be changed – **Precision: 0.0, Graph Low: 0 mA, Graph High: 20 mA**. In the next step we define Profile/timer. There are two methods to configure Profiles/timers, first in the **Profiles/timers menu** (see Chapter 7.11 PROFILES/TIMERS and Example 7.11.4.1) and second in the **Logical channel** in the **Profile/timer** mode. We choose a second method. Using arrows in upper navigation bar select the **Logical channel 2** and select the **Profile/timer** mode and as source select not yet defined **Profile 1**. Sets its name **“Profile 1”** We enter **Configure source** and select **edge (once)** in the parameter **Triggering mode**. In the parameter **Triggering source** we select Logical channel 1 **“Triggering”**. **Idle value** sets to 0, the parameter **Looping** as a disabled. We go to **Section list** menu by pressing the button. In the menu the mark '+' means adding new section and mark '-' - delete selected a section. In the block of parameters: **Duration, Shape** and **Final value** we set appropriate values is defined above e.g. first section: **Duration 5s, Shape: ramp** and **Final value: 10**. Exit from the configuration source. Due to we do not need any post processing its both parameters can be disabled (**Scaling: disabled, Filter type: disabled**). Default displaying mode is Format: **Numeric**, and precision: **0, Graph Low: 0 °C, Graph High: 20**.

We have defined logical channel. Next exit from the menu **Input channels**. To visualise the data, channel must be added to some group.

Using **Configuration menu** enter **Groups** definition, and enable **Group 1 (Group: enabled)**. Then change its name to e.g. **“User Profile”**, and select sources of data to be presented. To do this move window over parameters called **Channels** and set them as follow - **Slot 1: Log. ch. 1 “Triggering”, Slot 2: Log. ch. 2 “Profile 1”; Slot 3: disabled, Slot 4: disabled, Slot 5: disabled; Slot 6: disabled**.

After whole configuration exit the menu pressing Save changes, the result should be visible as soon as first measurement is done.

7.9. BUILT-IN OUTPUTS

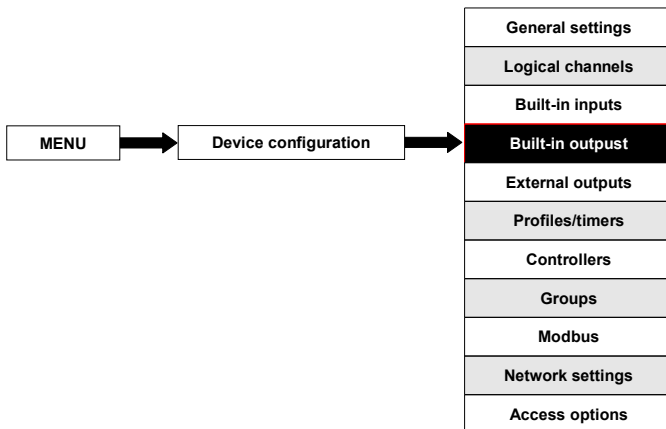

Build-in outputs menu is directly related to the available outputs installed in the device. The basic version includes outputs:

- built-in **Sound signal** output is always marked as **Out.X1: Sound signal** - more about the **Sound signal** output see **Chapter 7.9.2**,
- 16 built-in **Virtual relays** marked as **Out.V1: Virtual relay ÷ Out.V16: Virtual relay** - more about **Virtual relay** see **Chapter 7.9.2**,

Depending on customer's needs output modules (description of available output modules is provided in **Appendix 8. APPENDIX - input and output modules description** and the producer's website) can be installed in respective slots A, B or C (location of slot see Fig. 4.8) .

7.9.1. Build-in outputs - general settings

Available in the device in the basic configuration is **17 Built-in outputs (Sound signal and 16 Virtual relay)** and output modules installed in the device depending on customer's needs. Configured output can be used to control any process or can be used by any logical channel switches to **Hardware output monitor** mode in order to visualize the result, or used for further processing the output data.

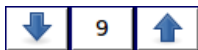

Arrows placed in the upper right corner of the screen allow you to switch between built-in outputs. The middle button allows you to directly select a specific built-in output from the list.

Parameters common for built-in outputs:

- **Name** - each outputs already has a name given by the device and user cannot change it - see Fig. 7.63,
- **Source** - after pressing the button next to the **Source** label a list of logical channels appears (up to 60), where the selected logical channel will be a data source for this built-in output (see Fig. 7.64).

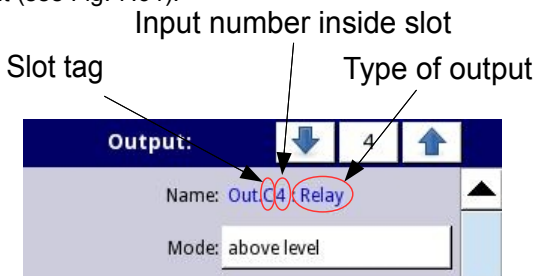

Fig. 7.63. Description of **Name** parameter in **Built-in outputs** menu

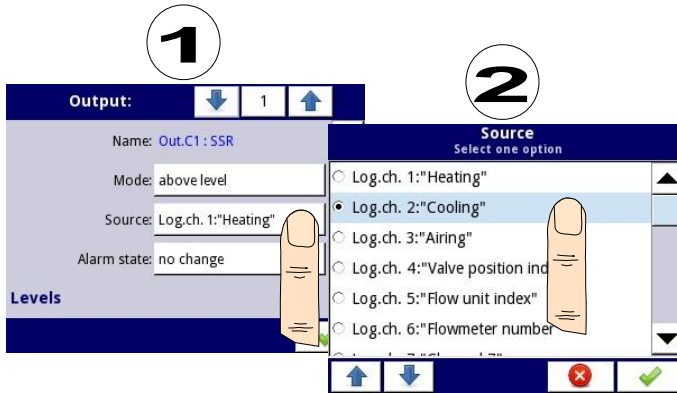

Fig. 7.64. Data source settings for built-in output (for SSR output module)



To check list of build-in output modules (slot tag and type of module) enter **Device information** menu, and read description of slots (see **Chapter 7.4. DEVICE INFORMATION, LICENSE AND FIRMWARE UPDATE**).

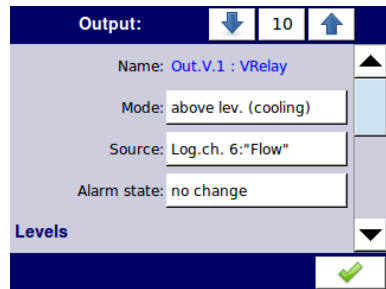
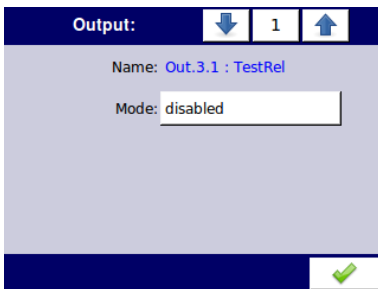

Fig. 7.65. Main settings of disabled (left) and enabled (right) output

State of physical outputs can be used as source for **Logical Channels** (for details see **Chapter 7.8.3. Logical Channels in Hardware output monitor mode**)

7.9.2. Built-in Output: Relay, Sound signal, Virtual relay

The parameters of build-in outputs for: Relay, Sound signal, Virtual relay are:

- **Name** - each outputs already has a name given by the device and user cannot change it - see Fig. 7.63,
- **Mode** - this parameter allows the user to select the method of operation of the output, **Mode** parameter has options (see Fig. 7.66 and Fig. 7.67):
 - **disabled** - the built-in output is inactive,
 - **above level** - the result is a high state when the input data (see **Source**

parameter) is above the level (see **Level** parameter block), otherwise the output is low state,

- **below level** - the result is a high state when the input data (see **Source** parameter) is below the level (see **Level** parameter block), otherwise the output is low state,
 - **inside range** - the result is a high state when the input data (see **Source** parameter) will be within the range (see **Level** parameter block), otherwise the output is low state,
 - **outside range** - the result is a high state when the input data (see **Source** parameter) will be out of the range (see **Level** parameter block), otherwise the output is low state,
 - **PWM** - this option visible only for SSR relay output type, PWM mode is discussed in **Chapter 7.9.3. Build-in output: PWM mode for SSR relay output**,
- **Source** - after pressing the button next to the **Source** label a list of logical channels appears (up to 60), where the selected logical channel will be the data source for this built-in output (see Fig. 7.64).
 - **Alarm state** - the **Alarm state** is when the value of Logical channel in which the data source for built-in output returns **Error** state or the state of the exceeding range: the low **-Lo-** state and high **-Hi-** state. In this case, the device can detect this state and set the output value to:
 - **no change** - means that at the time of an alarm state there is no change in the output,
 - **immediate OFF** - means that in times of alarm state the device immediately switches the output to low state,
 - **immediate ON** - means that in times of alarm state the device immediately switches the output to high state,
 - **timed OFF** - means that in times of alarm state the device switches the output to low state after time delay set in **Timing** parameter block,
 - **timed ON** - means that in times of alarm state the device switches the output to low state after time delay set in **Timing** parameter block,
 - for **PWM** mode in SSR relay module instead of **Alarm state** parameter is **Alarm level** parameter which allows the user to enter value at the output in times of alarm state (for more information see **Chapter 7.9.3. Build-in output: PWM mode for SSR relay output**)
 - **Levels** block parameter - these parameters allows the user to set range of changes of the output depending on the input signal, is discussed below in this **Chapter**,
 - **Timing** parameter block - these parameters allows the user to set delay time change the output state and minimum duration of the output state, is discussed below in this **Chapter**,



For **Built-in outputs: Relay, Sound signal** and **Virtual relay** the **low state** is value '0' and the **high state** is value '1'.

Levels parameter block (see Fig. 7.66, Fig. 7.67 and Fig. 7.68)

This parameters depends on the **Mode** parameter. The parameters are:

- **Level** - this parameter defines the source signal level at which the output switches the state (from low to high state or vice versa from high to low state), occurs for the mode:

- **above level** - above the level at the output we get high state,
- **below level** - below the level at the output we get high state,
- **Lower level and Upper level** - these parameters define the range at which a switches the output state (from low to high state or vice versa from high to low state), occurs for the mode:
 - **inside range** - if the input data is within the defined range at the output we get high state,
 - **outside range** - if the input data is outside the defined range at the output we get high state,
- **Hysteresis** - defining this parameter, the user can move the level (**upper** - value of **Level+Hysteresis** parameters and **lower** - value of **Level-Hysteresis** parameters) for changes in output state,
- **Alarm level** - this parameter is only visible for **PWM** mode, allows the user to enter value of fill of the pulse in times of alarm state (for more information see **Chapter 7.9.3. Build-in output: PWM mode for SSR relay output**)

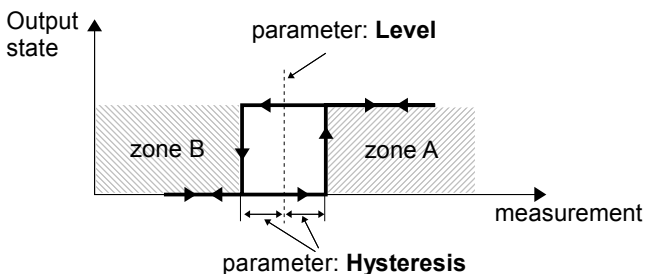

Fig. 7.66. One threshold control of the relay outputs

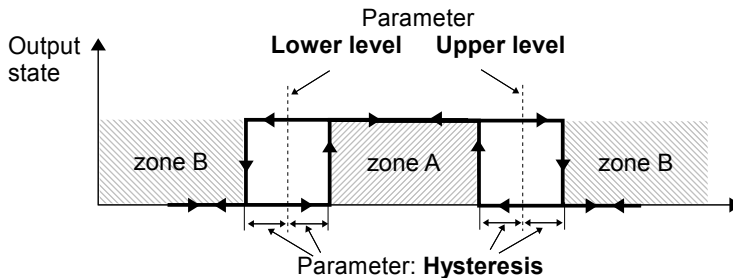

Fig. 7.67. Two threshold control of the relay outputs

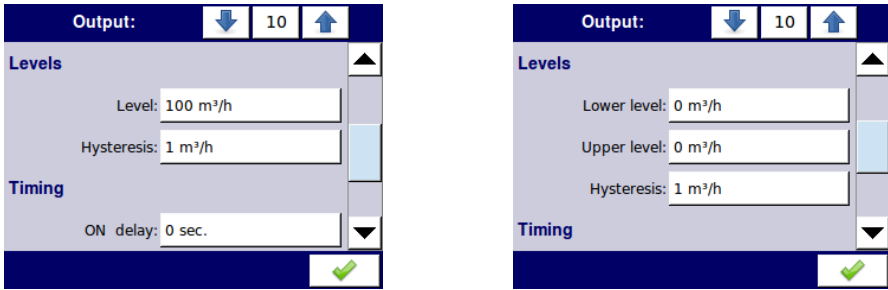

Fig. 7.68. **Levels** settings for above level mode (left) and inside range (right)

Timing parameter block

The parameters of this block include:

- **ON delay** - this parameter allows the setting of the time that must pass from the time of exceeds **Level** value until the output switch from low to high state (see Fig. 7.70),
- **OFF delay** - this parameter allows the user to set the time that must pass from the time of exceeds **Level** value until the output switch from high to low state (see Fig. 7.70),
- **Minimum ON time** - the minimum duration of a high state (if the output switches to high state the low state will occur after the **Minimum ON time**),see Fig. 7.69
- **Minimum OFF time** - the minimum duration of a low state (if the output switches to low state the high state will occur after the **Minimum OFF time**),see Fig. 7.69

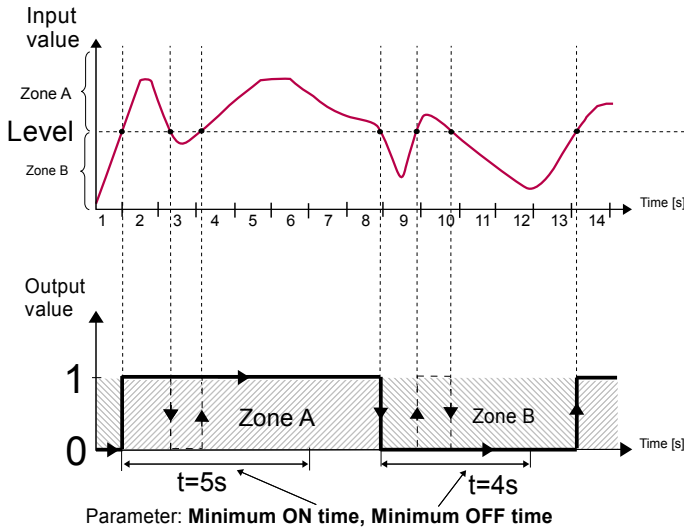

Fig. 7.69. Principle of relay output operation for sample timing settings: **Min. ON time**=1 sec., **Min. OFF time**=4 sec.

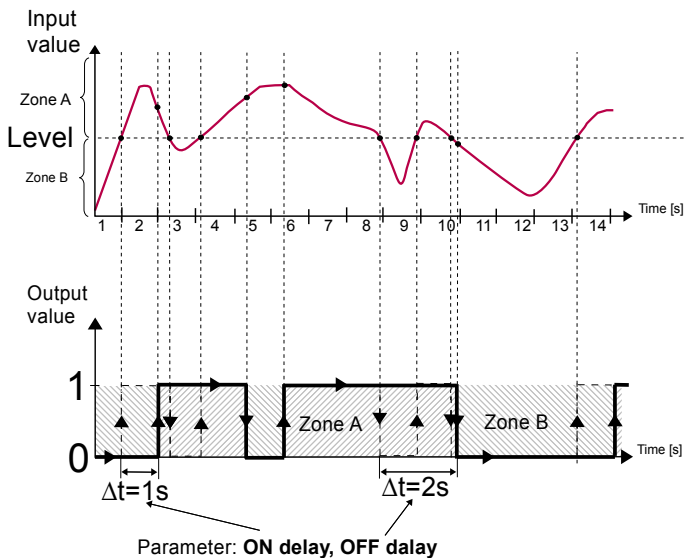

Fig. 7.70. Principle of relay output operation for sample timing settings:

ON delay=1 sec., OFF delay=2 sec.

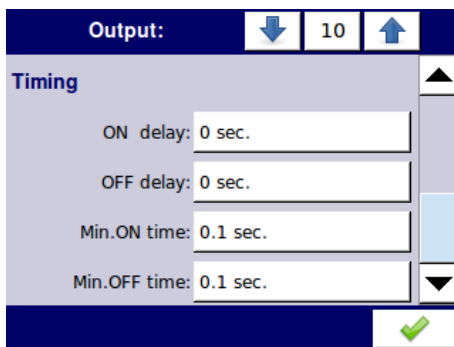

Fig. 7.71. Timing settings for different modes

7.9.3. Build-in output: PWM mode for SSR relay output

Technical specifications of SSR relay can be found in **Appendix 8.8. S8, S16 - SOLID STATE RELAY DRIVERS MODULES**

Built-in outputs parameters in **PWM** mode are:

- **Name** - each outputs already has a name given by the device and user cannot change it - see Fig. 7.63,
- **Mode=PWM** - this parameter allows the user to select method of operation the output,

- **Source** - after pressing the button next to the **Source** label a list appear of logical channels (up to 60), where the selected logical channel will be a data source for this built-in output (see Fig. 7.64).
- **Levels** block parameter - these parameters allow the user to set range of changes of the output depending on the input signal, is discussed below in this **Chapter**,
- **Timing** parameter block - these parameters allow the user to set delay time change the output state and minimum duration of the output state, is discussed below in this **Chapter**,

Levels parameter block

The parameters are:

- **Lower level** and **Upper level** - by setting these parameters range is defined within which the change width of pulse depending on the source signal; below this range the signal is zero (zero width) and above this range the signal is completely filled (Fig. 7.72),
- **Alarm level** - when the Logical channel from which the data source for built-in output returns **Error** state or the range being exceeded: the low **-Lo-** state and high **-Hi-** state, **Alarm level** parameter for the PWM mode allows setting the fill of the pulse in time of alarm state according to the parameters of **Lower level** and **Upper level**,

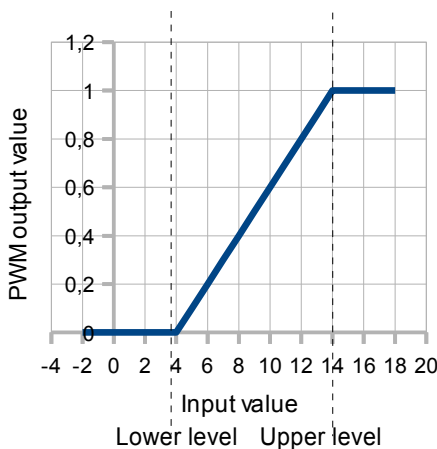

Fig. 7.72. Input-output characteristic of signal in PWM mode for parameters: **Lower level=4**, **Upper level=14**

Timing parameter block

The parameters of this block include:

- **Period** - the output pulse (the minimum value is 0.1 seconds)
- **Minimum ON time**,
- **Minimum OFF time**,

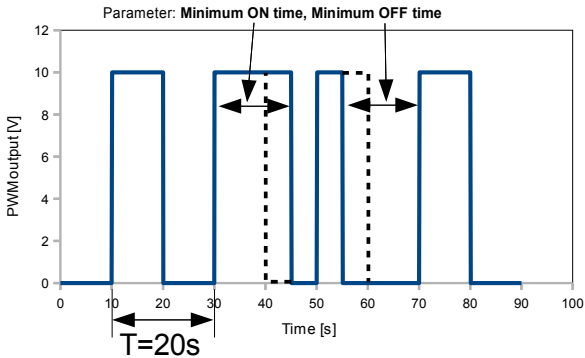

Fig. 7.73. Sample of output signal of SSR relay in PWM mode

7.9.4. Build-in output - Current output

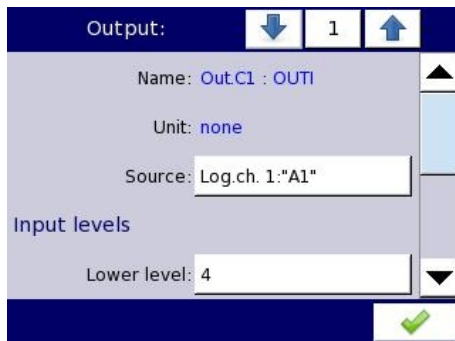

Fig. 7.74. Menu of the Passive current output

The parameters of built-in output for **Current outputs** module are:

- **Name** - each outputs already has a name given by the device and user cannot change it - see Fig. 7.74,
- **Unit** - for this module the unit is defined ([mA]) and user cannot change it,
- **Source** - after pressing the button next to the **Source** label a list appears of logical channels (60), where the selected logical channel will be a data source for this built-in output,
- **Input levels** parameter block - determine the range of data source for this built-in output, this block has parameters:
 - **Lower level** and **Upper level** - these parameters limit the range of the input signal selected in **Source** parameter, below this range input signal is **Lower level** value and above this range the signal will be **Upper level** value.
- **Output levels** parameter block - determine the range of output value, this block has the following parameters:
 - **Lower level** and **Upper level** - these parameters limit range of the output signal

based on **Input levels** parameter, below this range input signal is **Lower level** value and above this range the signal will be **Upper level** value, see Fig. 7.76,

- **Alarm level** - when input signal returns **Error** state or the state of exceeding range: the low **-Lo-** state and high **-Hi-** state the user can define output value for alarm state according to the parameters of **Lower level** and **Upper level**,

Lower level and **Upper level** parameter describe the transfer equation (linear) - see Fig. 7.75. **Lower level** of the output defines the current which can be generated when the value of the input signal is equal to the **Lower level**. **Upper level** of the output defines the current which can be generated when the value of the input signal is equal to the **Upper level**.

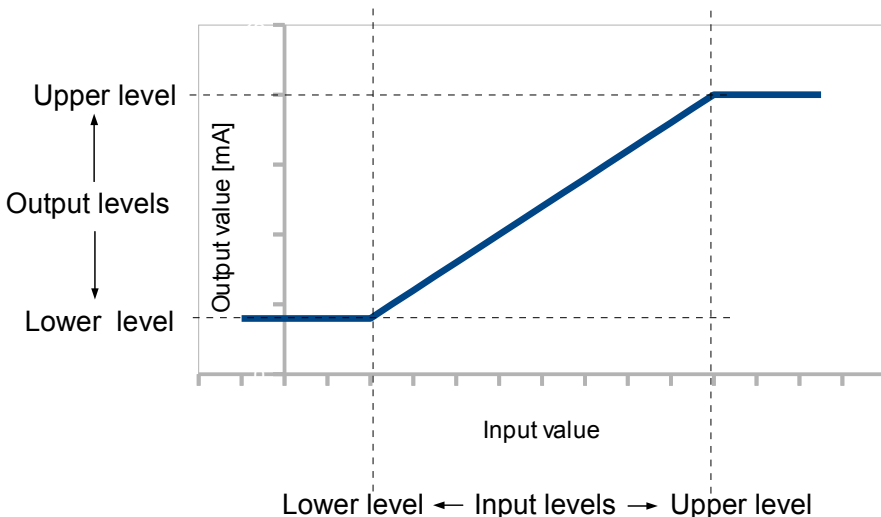

Fig. 7.75. Input-output characteristic of signal in PWM mode for parameters: **Lower level=4**, **Upper level=14**

Output: 1

Unit: none

Source: Log.ch. 1:"A1"

Input levels

Lower level: 4

Upper level: 20

Output: 1

Upper level: 20

Output levels

Lower level: 4 mA

Upper level: 20 mA

Alarm level: 4 mA

Fig. 7.76. Parameters of the **Passive current** output

7.9.5. Examples of build-in output configurations

Example 7.9.5.1: Application of the output for r45, r81 modules (see Appendix 8.9 R45, R81 - RELAY MODULES).

Task:

Let's say that we would like to control temperature in some room by switching ON and OFF an electric heater. The temperature be measured using PT-100 sensor and **RT4** input module, and let the heater be controlled using internal 5A relay (**R45** module).

Solution:

To realize such task it is necessary to define at least one **Logical channel**. First, we defined **Logical Channels**. We enter to the **Device configuration** → **Input Channels** menu and using arrows in upper navigation bar select **Logical Channel 1**, and set its name "**Temperature**" and mode: **Hardware input**. Next we can select the source. Assuming that sensor installed in the room is connected to **Physical Input A1** select this input as a source. Next press button **Configure source** to enter hardware configuration. In this panel in the parameter **Mode** select the type of the sensor and connection method **PT100**, next set **Low Limit**: -50°C and **High Limit**: 600°C. Finally exit hardware configuration. Due to we do not need any post processing its both parameters can be disabled (**Scaling: disabled, Filter type: disabled**). Default displaying mode is **Numeric** format, and it is proper for this purpose, but we can change **Precision** and extend it by one digit after decimal point. Also lower and upper ends of graph can be changed. Lets say that temperature in the room can vary from 18 to 27 degrees, so we can set such range with e.g. 3 deg of margin. (**Graph low = 15.0, Graph high = 30.0**;). We have defined logical channel. Next exit from the menu **Input channels**.

Then we define hardware output. We enter to the **Device configuration** → **Build-in outputs** menu and using arrows or pressing middle button with a number in upper navigation bar select **Output 1**. Then switch its mode to "**below level**" (**heating**), and define source of input data as follows **Source: Log. ch. 1 "Temperature"**. Select the Alarm state: **immed.OFF** which will switch off the heater when the sensor is damaged. Finally define desired **Level** of switching - 23, and the **Hysteresis** - 2. To prevent relay against often switching it is possible and set minimal ON and OFF times and delays. Save the changes to finish the configuration. From this moment **Relay C1** will be switched ON when temperature in controlled room drop below assumed level (minus **Hysteresis**) and OFF when temperature is higher then this level plus **Hysteresis**.

Example 7.9.5.2: Application of output for IO2, IO4 modules (see the Appendix 8.10 IO2, IO4 - PASSIVE CURRENT OUTPUT).

Task:

Assume that **Logical Channel 1** indicates pressure in range 100 – 500 bars, and its result should be regenerated to current output in corresponding range „4-20mA”.

Solution:

We enter to the **Device configuration** → **Build-in outputs** menu and using arrows or pressing middle button with a number in upper navigation bar select output you want to use e.g. **Output 1**. Next set: **Source: Logical Channel 1**, (then unit of **Input Levels** will be changed automatically to "bar"), **Input Lower level**: 100 bar, **Input Upper level**: 500 bar, **Output Lower level**: 4 mA, **Output Upper level**: 20 mA, **Alarm Level**: 3.5mA

Due to fact that output is passive type, it is required to power the current loop. Schematic is shown in the Fig. 8.12. Note that polarisation of IO2 and IO4 outputs has no matter.

7.10. EXTERNAL OUTPUTS

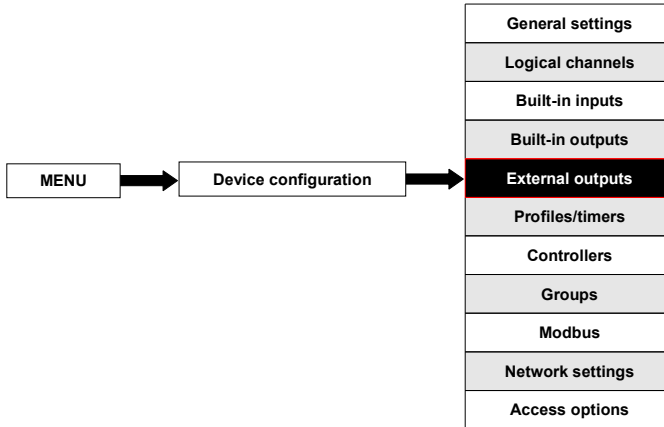

This menu is related to sending the data to SLAVE device using Modbus communication protocol. In this menu it is determined what data will be send to SLAVE device while the configuration of Modbus in Master mode (for example baud rate, define the SLAVE device, active output register list and etc.) is defined in the **Modbus** menu (see **Chapter 7.14.3. Modbus - MASTER mode**).

7.10.1. External outputs - general settings

In the device there are as many external outputs as will be defined in the **Modbus** menu are available (see **Chapter 7.14.3. Modbus - MASTER mode**). In case when the external outputs are not defined or inactive than in **External outputs** menu is an empty list. External outputs have a control type (control type setting, see **Chapter 7.14.3.2. Modbus MASTER- Device channels parameter block**):

- as a relay,
- as a linear output,

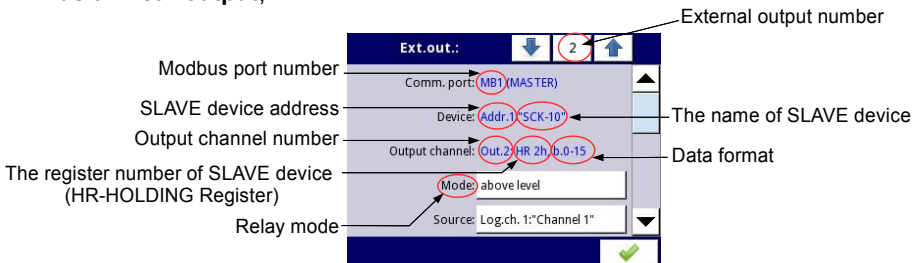

Fig. 7.77. View of External outputs menu for 'as a relay' type control

View of **External outputs** menu is created for two types of control: as a relay (digital output) and a linear output (analog output) is shown in Fig. 7.77 and Fig. 7.78, respectively.

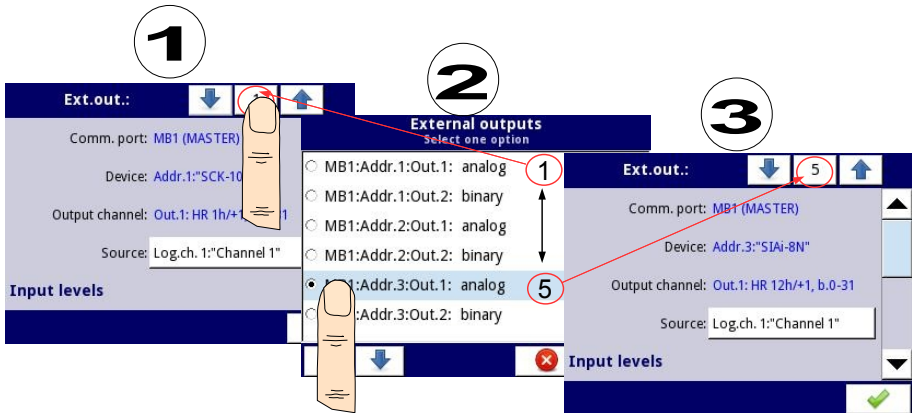

Fig. 7.78. View of External outputs menu for 'as a linear output' type control



Arrows placed in the upper right corner of the screen let you switch between a succession of external outputs. The middle button allows direct selection of a specific external output from the list.

The parameters that are common for the **External outputs** (refer to Fig. 7.77 and Fig. 7.78) are:

- **Communication port** - this parameter is read only, and indicates the Modbus port number, a description of Modbus ports configuration and view of the Modbus port connectors is located in **Chapter 7.14. MODBUS**,
- **Device** - this parameter is read only, it shows address and name of the SLAVE device configured in Modbus menu (**Chapter 7.14.3. Modbus - MASTER mode**),

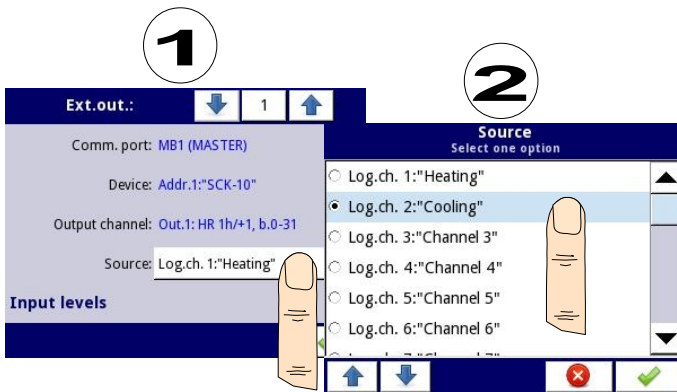

Fig. 7.79. Sample selection of **Source** for External output

- **Output channel** - this parameter is read only, it shows output channel number, type of register and data format configured in Modbus menu (each SLAVE device as defined in a specific address, has its output list individually numbered),

- **Source** - after pressing the button next to **Source** label a list appears of Logical channels where the selected Logical channel will be data source for External output (see Fig. 7.79),

7.10.2. External outputs - Control type = as a relay

The output has two state, **low state: value '0'** and **high state: maximal value** (for 16-bit format is the value 65535),

The parameters of **External outputs** in the type of control **as a relay** are (see Fig. 7.78):

- **Communication port** - this parameter is read only, device displays here parameter the Modbus port number, a description of Modbus ports configuration and indication of the Modbus port connectors is located in **Chapter 7.14. MODBUS**,
- **Device** - this parameter is read only, it shows address and name of the SLAVE device configured in **Modbus** menu (**Chapter 7.14.3. Modbus - MASTER mode**),
- **Output channel** - this parameter is read only, it shows output channel number, type of register and data format configured in Modbus menu (each SLAVE device as defined in a specific address, has its output list individually numbered),
- **Mode** - this parameter allows the user to select the method of operation the external output, **Mode** parameter has options (see Fig. 7.66 and Fig. 7.67):
 - **disabled** - for **Mode=disabled** further parameters are not visible,
 - **above level** - the result is a high state when the input data (see **Source** parameter) is above the level (see **Level** parameter block), otherwise the output is low state,
 - **below level** - the result is a high state when the input data (see **Source** parameter) is below the level (see **Level** parameter block), otherwise the output is low state,
 - **inside range** - the result is a high state when the input data (see **Source** parameter) will be within the range (see **Level** parameter block), otherwise the output is low state,
 - **outside range** - the result is a high state when the input data (see **Source** parameter) will be out of the range (see **Level** parameter block), otherwise the output is low state,
- **Source** - after pressing the button next to **Source** label a list appears of Logical channels where the selected Logical channel will be data source for External output,
- **Alarm state** - the **Alarm state** is when the value of Logical channel which the data source for built-in output returns **Error** state or the state of exceeding range: the low **-Lo-** state and high **-Hi-** state. In this case, the device can detect this state and set the output value to:
 - **no change** - means that at the time of an alarm state there is no change on the output,
 - **immediate OFF** - means that in times of alarm state the device immediately switches the output to low state,
 - **immediate ON** - means that in times of alarm state the device immediately switches the output to high state,
 - **timed OFF** - means that in times of alarm state the device switches the output to low state after time delay set in **Timing** parameter block,
 - **timed ON** - means that in times of alarm state the device switches the output to low state after time delay set in **Timing** parameter block,
- **Levels** block parameter - these parameters allow the user to set range of changes of

- the output depending on the input signal, is discussed below in this **Chapter**,
- **Timing** parameter block - these parameters allow the user to set delay time change the output state and minimum duration of the output state, is discussed below in this **Chapter**,

Levels parameter block (see Fig. 7.66, Fig. 7.67 and Fig. 7.68)

This parameters depends on the **Mode** parameter. The parameters are:

- **Level** - this parameter defines the source signal level at which the output switches the state (from low to high state or vice versa from high to low state), occurs for the mode:
 - **above level** - above the level we get high state at the output,
 - **below level** - below the level we get high state at the output,
- **Lower level and Upper level** - these parameters define the range at which a switch the output state (from low to high state or vice versa from high to low state), occurs for the mode:
 - **inside range** - if the input data is within the defined range at the output we get high state,
 - **outside range** - if the input data is outside the defined range at the output we get high state,
- **Hysteresis** - defining this parameter, the user can move the level (**upper** - value of **Level+Hysteresis** parameters and **lower** - value of **Level-Hysteresis** parameters) for changes in output state,
- **Alarm level** - this parameter is only visible for **PWM** mode, allows the value of fill of the pulse in times of alarm state to be entered (for more information see **Chapter 7.9.3. Build-in output: PWM mode for SSR relay output**)

Timing parameter block

The parameters of this block include:

- **ON delay** - this parameter allows the user to the time that must pass from the time of exceeds **Level** value being exceeded until the output switch from low to high state to be set (see Fig. 7.70),
- **OFF delay** - this parameter allows the user to the time that must pass from the time of exceeding **Level** value until the output switch from high to low state to be set (see Fig. 7.70),
- **Minimum ON time** - the minimum duration of a high state (if the output switches to high state the low state will occur after the **Minimum ON time**),see Fig. 7.69
- **Minimum OFF time** - the minimum duration of a low state (if the output switches to low state the high state will occur after the **Minimum OFF time**),see Fig. 7.69



Note! If external output is active (see the parameter **Output active=yes** in the **Chapter 7.14.3.2. Modbus MASTER- Device channels parameter block**) for **Mode=disabled** the MultiCon send to Slave device value '0'.

7.10.3. External outputs - Control type = as a linear output

The parameters of **External outputs** in the type of control **as a linear output** are (see Fig. 7.78):

- **Communication port** - this parameter is read only, device display in this parameter the Modbus port number, a description of Modbus ports configuration and view of the Modbus port connectors is located in **Chapter 7.14. MODBUS**,

- **Device** - this parameter is read only, it shows address and name of the SLAVE device configured in **Modbus** menu (**Chapter 7.14.3. Modbus - MASTER mode**),
- **Output channel** - this parameter is read only, it shows output channel number, type of register and data format configured in Modbus menu (each SLAVE device as defined in a specific address, has its output list individually numbered),
- **Source** - after pressing the button next to the **Source** label a list of logical channels appears (60), where the selected logical channel will be a data source for this external output,
- **Input levels** parameter block - determine the range of data source for this external output, this block has parameters:
 - **Lower level** and **Upper level** - these parameters limit the range of the input signal selected in **Source** parameter, below this range input signal is **Lower level** value and above this range the signal will be **Upper level** value.
- **Output levels** parameter block - determine the range of output value, this block has parameters:
 - **Lower level** and **Upper level** - these parameters limit the range of the output signal based on **Input levels** parameter, below this range input signal is **Lower level** value and above this range the signal will be **Upper level** value, see Fig. 7.76,
 - **Alarm level** - when input signal returns **Error** state or the state of exceeding range: the low **-Lo-** state and high **-Hi-** state the user can define output value for alarm state according to the parameters of **Lower level** and **Upper level**,

Lower level and **Upper level** parameter describe the transfer function (linear, see Fig. 7.80). **Lower level** of the output defines the value which can be generated when the value of the input signal is equal to the input **Lower level**. **Upper level** of the output defines the value which can be generated when the value of the input signal is equal to the input **Upper level**.

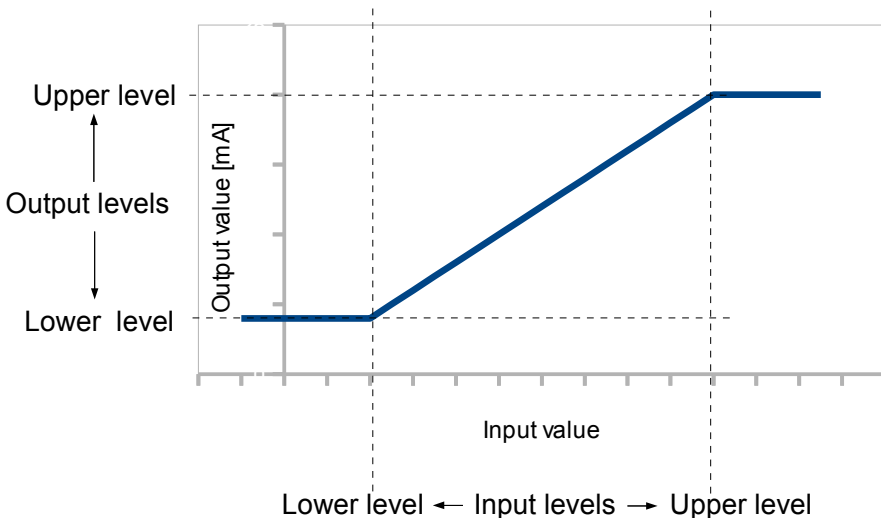

Fig. 7.80. The relation between the input and output for **External output**



Note! If external output is active (see the parameter **Output active=yes** in the **Chapter 7.14.3.2. Modbus MASTER- Device channels parameter block**) for undefined **Source** parameter (e.g. a Logical channel in the **Mode=disabled**) or for undefined **Input** and **Output levels** parameter block (every parameter has value 0) the MultiCon send to Slave device value '0'.

7.10.4. Examples of external output configurations

Example 7.10.4.1: Application of external output for protocol Modbus in the MASTER mode.

Lets assume that we want to send the date to TRS-10a (the indicator) by protocol Modbus. We know the address (address 5) of the SLAVE device and a registry number (register 1).

The first step is to configure appropriate parameters for the Modbus (Master) menu (see Chapter 7.14 MODBUS and Example 7.14.5.3) i.e. baud rate, the definition of SLAVE device (the output must be a linear type), etc. Next we define the **Logic channel**. After entry to **Input channels** configuration we can configure **Logical Channel** using arrows or pressing middle button with a number in upper navigation bar select **Logical Channel 1**. Sets its name to "**Date**", and **Mode** to **Set point value**. The parameter **Unit** sets empty and in the **Set point value** parameter we enter the value e.g. "**10**". Default displaying mode is Format: **Numeric**, and precision: **0**, Graph Low: **0**, Graph High: **300**. Next exit from **Input channels** menu and go to the **External outputs** menu.

Using arrows or pressing middle button with a number in upper navigation bar select External output that you want to define – search Comm. Port MB1 (MASTER), Device: Addr.5:"TRS-10a", Output channel: Out.1:HR 1h,b.0-15. Next we select source Log.ch. 1:"Date". Than we set Input levels. Because in the Logical channel 1 we set displaying range of 0 to 300 than in the **Input levels** we set parameters: **Lower level:** 0 and **Upper level:** 300. Due to we want linear output without scaling than we set **Output levels:** **Lower level** 0 and **Upper level** 300. **Alarm level** we set to 0.

After whole configuration exit the menu pressing Save changes, the result should be visible as soon as you exit the menu.

7.11. PROFILES/TIMERS

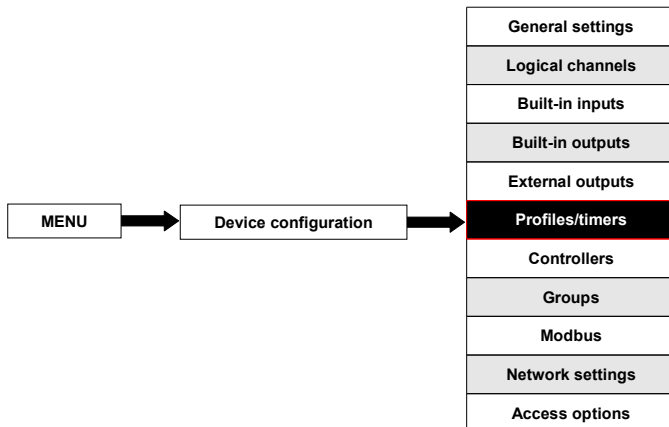

Profiles/timers menu allow user to defined any profile/timer which can be used to control any process.

7.11.1. Profile/timer - general settings

In the MultiCon is there are **8 independent settings of Profiles/timers** available. Configured **Profile/timer** can be used by any **Logical channel** switched to **Profile/timer** mode - Fig. 7.81 (see also **Chapter 7.8.8. Logical Channels settings for Profile/timer mode**).

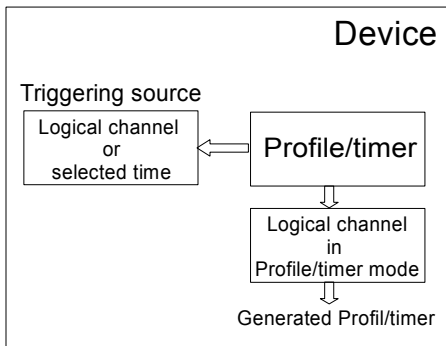

Fig. 7.81. Block diagram of the device configuration for generating Profiles/timers

The window with basic parameters of the **Profile/timer** shown on Fig. 7.82.

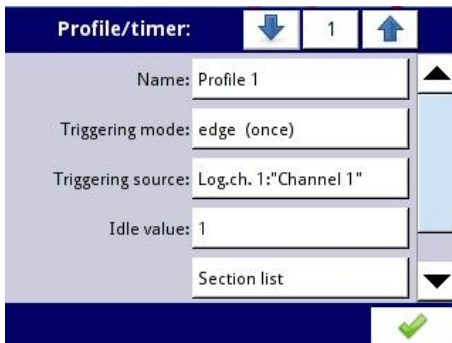
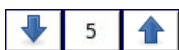

Fig. 7.82. View of the configuration Profiles/timers window

In **Profiles/timers** menu user can set:



Arrows placed in the upper right corner of the screen allow you to switch between Profile/timer. The middle button allows you to directly select a specific Profile/timer from the list.

Common parameters for **Profile/timer** are:

- **Name** - to change a name of Profile/timer press the button next to the Name label,
- **Triggering mode** - using this parameter user select a way to generated Profile/timer,

there are five modes of triggering:

- **disabled**,
 - **level (gate)** - this means that which was configured by user **Profile** is generated when source signal will have a value > 0 , otherwise (if source value ≤ 0) defined Profile will not be generated,
 - **edge (once)** - this means that which was configured by user **Profile** will be triggered by rising edge signal (from values ≤ 0 to the value > 0) come from source signal. After the rising edge the **Profile** will be generated in whole (once), regardless of further changes to the signal source,
 - **edge (re-triggering)** - this means that configured by user **Profile** will be triggered by rising edge signal (from values ≤ 0 to the value > 0) that comes from source signal. However, in this mode, unlike the **edge (once)** mode a defined **Profile** will be generated from the beginning every time when the Triggering source signal will generate a edge, whether that Profile had been completed or not,
 - **on time** - in this mode the **Profile/timer** is generated in selected time (using parameter **Triggering times**),
- **Idle value** - is the value before and after generating the defined the Profile,
 - **Section list** - invokes sub-menu which the user sets shape of the Profile,
 - **Looping** - each Profile can be repeated:
 - **disabled** - the **Profile** is generated only once,
 - **counted** - this option allows the user to generated **Profile** specified number of times defined using **Loop count** parameter,
 - **infinite** - this option allows the user to infinite repeated of generated **Profile**,
 - **Loop count** - this parameter is visible only for **Looping=counted**, allows the user to enter number of repetitions generated Profile,
 - **Return to position** - this parameter is invisible for **Looping=disabled**, allows user to select a fixed position from which it is to be generated each successive Profile,

Section list Sub-menu

This sub-menu allows the user to defined shape of the **Profile** signal, that is: duration, shape and final value of each section.



This button allows the addition of a new section to list.



This button allows the removal of the section from the list.

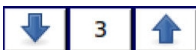

Arrows placed in the upper right corner of the screen allow switching between sections. Middle button allows direct selection of a specific section.

The **Section list** parameters are:

- **Duration** - the duration of the section depends on the **Unit** parameter,
- **Unit** - user can select available options: **second**, **minute**, **hour** which sets unit of the duration,
- **Shape** - user can select any of these available options: **constant value**, **slope** which sets the shape of the defined section,
- **Final value** - this parameter allows the setting of the final value of the defined section,

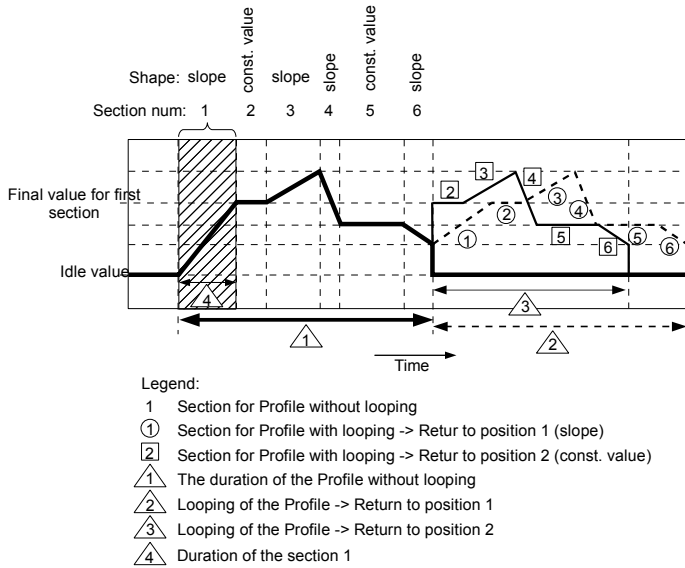

Fig. 7.83. Sample of Profile/timer with description of parameters

Comments for **Looping** parameter

If the user select: **counted** or **infinite**, repeats of the Profile/timer the user has:

- if the section from which begins the next repeat Profile/timer is a **ramp**, then in the whole duration of this section is linear generating the output signal from the **final value** of the previous section to **final value** this section. This is shown in Fig. 7.83 (dashed line-run profile)
- if the section from which the next repeat of the Profile/timer begins is a constant value, then Profile signal quickly transient (0.1 seconds) from the **final value** of the previous section to a **constant value** in this section. This is shown in Fig. 7.83 (profile guided fine line).

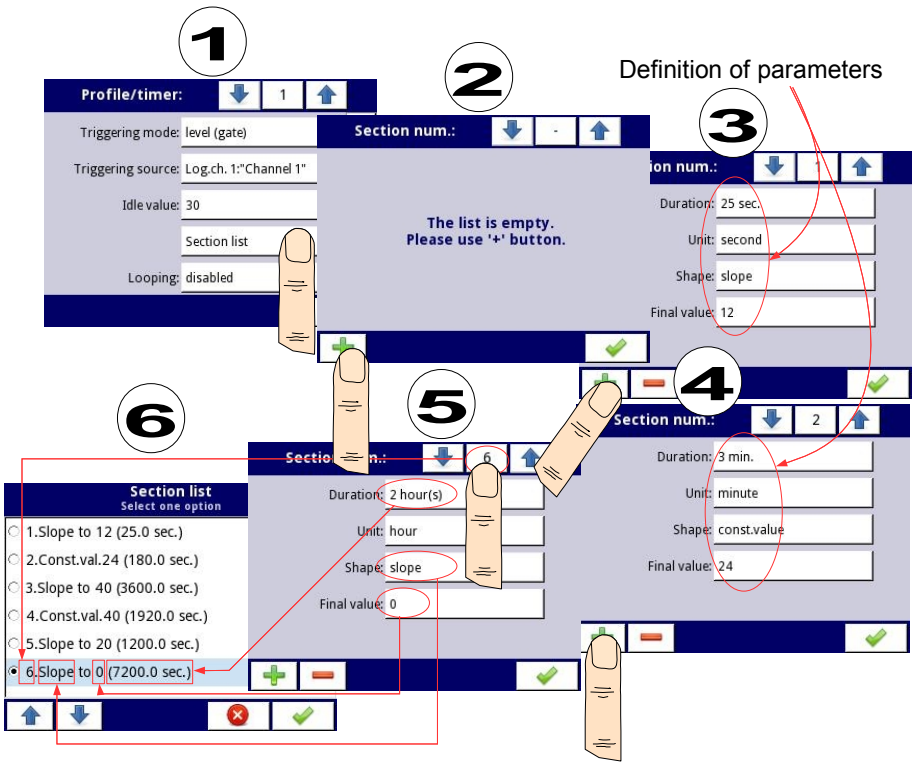

Fig. 7.84. Sample of Profile/timer configuration

7.11.2. Profiles/timers for triggering mode: level (gate), edge (once), edge (retrig.)

The parameters of Profiles/timers for triggering mode: level (gate), edge (once), edge (retrig.) are:

- **Name** - to change a name of Profile/timer press the button next to the Name label,
- **Triggering mode** - by using this parameter the user selects a way to generate Profile/timer, there are five modes of triggering:
 - **disabled**,
 - **level (gate)** - this means that configured by user **Profile** is generated when source signal will have a value > 0 , otherwise (if source value ≤ 0) defined Profile will not be generated, see example **a**) in the Fig. 7.85 and Fig. 7.86,
 - **edge (once)** - this means that configured by user **Profile** will be triggered by rising edge signal (from values ≤ 0 to the value > 0) from source signal. After the rise edge the **Profile** will be generated in whole (once), regardless of further changes to the signal source, see example **b**) in the Fig. 7.85 and Fig. 7.86,
 - **edge (re-triggering)** - this means that configured by user **Profile** will be triggered by rising edge signal (from values ≤ 0 to the value > 0) come from source signal. However, in this mode, unlike the **edge (once)** mode a defined **Profile** will be generated from the beginning every time when the **Triggering**

source signal will generate a edge, whether that Profile had been completed or not, see example **c**) in the Fig. 7.85 and Fig. 7.86,

- **on time** - in this mode the **Profile** is generated in selected time (using parameter **Triggering times**),
- **Triggering source** - after pressing the button next to the **Triggering source** label a list of Logical channel appears (from 60) which selected Logical channel will be triggering source of Profile/timer,
- **Idle value** - is the constant value which is the set point before and after generating the defined Profile,
- **Section list** - invokes sub-menu which user set shape of Profile,
- **Looping** - each Profile can be repeated:
 - **disabled** - the **Profile** is generated only once,
 - **counted** - this option allows the user to generated **Profile** specified number of times defined using **Loop count** parameter,
 - **infinite** - this option allows the user to infinite repetition of the generated **Profile**,
- **Loop count** - this parameter is visible only for **Looping=counted**, allows the entry of the number of repetitions of the generated Profile,
- **Return to position** - this parameter is invisible for **Looping=disabled**, allows user to select a fixed position from which it is to be generated each successive Profile,

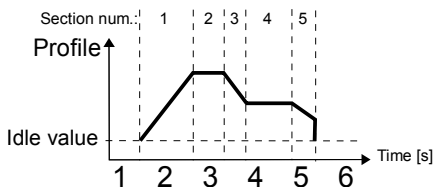

Fig. 7.85. Sample of Profile/timer

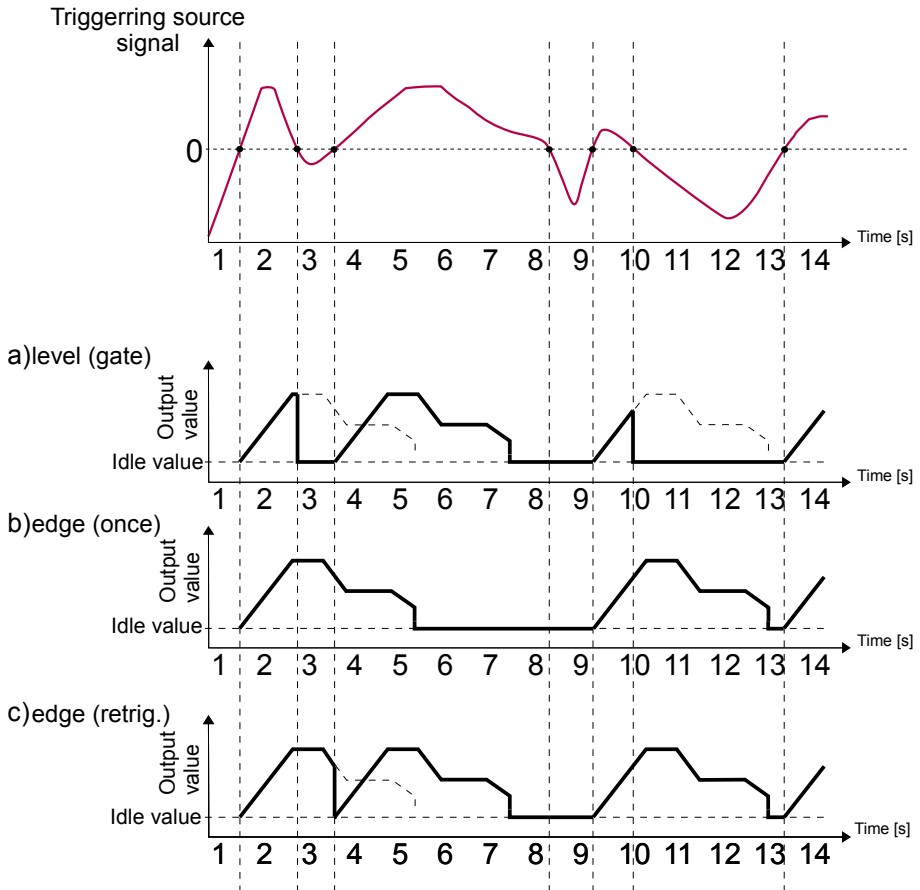

Fig. 7.86. Samples of **Profile** output waveforms defined in Fig. 7.85, triggered by signal selected in **Triggerring source** parameter

7.11.3. Profiles/timers for triggering mode: on time

The parameters of **Profiles/timers for triggering mode: on time** are:

- **Name** - to change a name of Profile/timer press the button next to the **Name** label,
- **Triggerring mode=on time** - in this mode the **Profile** is generated in selected time (using parameter **Triggerring times**),
- **Triggerring times** - this button enters sub-menu and allows the user to defining of triggering times of generated Profile, see below for more information about this sub-menu,
- **Idle value** - is the constant value of output signal which set before and after generating the defined Profile,
- **Section list** - invokes sub-menu in which the user configures the shape of Profile

- divided to sections,
- **Looping** - each Profile can be repeated:
 - **disabled** - the Profile is generated only once,
 - **counted** - this option allows the user to generation of number of times the specified Profile has occurred, defined using **Loop count** parameter,
 - **infinite** - this option allows the user to infinite repetition of generated Profile,
- **Loop count** - this parameter is visible only for **Looping=counted**, allows the entry of the number of repetitions of generated Profile,
- **Return to position** - this parameter is invisible for **Looping=disabled**, allows the user to select a fixed position from which it is to be generated from each successive Profile,

Triggering times

In Fig. 7.87 shown an example of **Triggering times** menu which allows the user to set up the time of generating the Profile. This menu has parameters:

- **Months** - in this parameter and all below parameters in this menu the user can select one or more options, if user does not select any option next to this parameter appears the description '**Press to select**' and in this case Profile/timer will not be generated,
- **Days**,
- **Week days**,
- **Hours**,
- **Minutes**,
- **Seconds**,

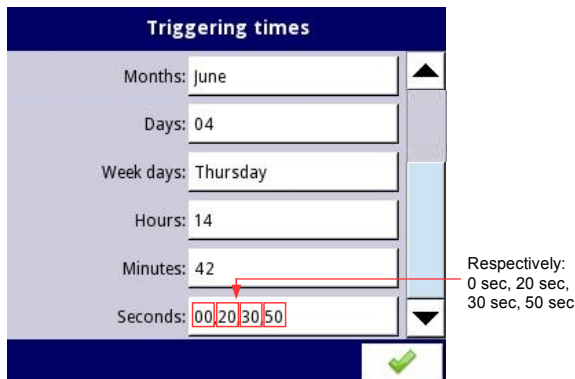

Fig. 7.87. Samples of time settings for Profile/timer

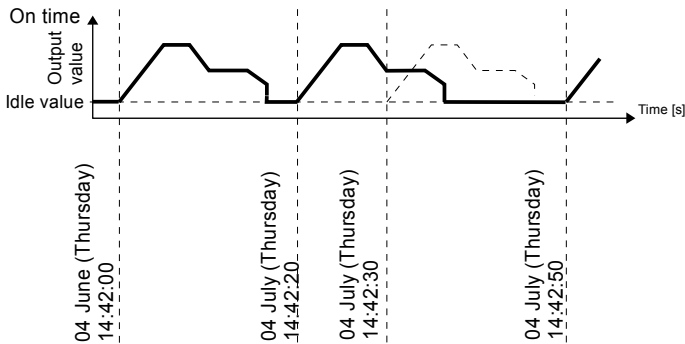

Fig. 7.88. Waveform for 'on time' triggering mode and time parameters in accordance with Fig. 7.87

In Fig. 7.87 and Fig. 7.88 shown examples of Profile/timer: triggering times configuration and output waveform. Operation of Profile in 'on time' mode is similar to **edge (once)** mode - see **Chapter 7.11.2** because after the rising edge of the triggering source the **Profile** will be generated in whole, regardless of further changes of the signal source at time generating the Profile.

7.11.4. Examples of Profile/timer configurations

Example 7.11.4.1: Application of the Profiles/timers.

This example describe the way to create the Profile in the logical channel 1 in **level (gate) trigger** mode. Triggering source of the Profile is the logical channel 2, which is set to hardware input – i.e. current input A1 (UI4). The Profile consists of 4 sections: 1. ramp from 0 to 10 in 5 seconds, 2. constant value 8 in 2 seconds, 3. ramp from 8 to 4 in 3 seconds and 4. constant value 4 in 1 seconds. Idle value is 0 and the loop is disabled.

There are two methods to configure Profiles/timers, first in the **Profiles/timers menu** and second in the **Logical channel** in the **Profile/timer mode**. In this case presents the first method. We enter to the **Device configuration** → **Profiles/timers** menu and using *arrows* or pressing middle button with a number in *upper navigation bar* select **Profile/timer 1**. Next we can change the name to "My Profile". We select **level (gate)** in the parameter **Triggering mode**. In the parameter **Triggering source** we select **Logical channel 1 "Triggering"** which be defined later. **Idle value** sets to 0, the parameter **Looping** as a disabled. We go to **Section list** menu by pressing the button. In the menu the mark '+' means adding new section and mark '-' - delete selected a section. In the block of parameters: **Duration**, **Shape** and **Final value** we set appropriate values as defined above e.g. first section: **Duration** 5s, **Shape**: ramp and **Final value**: 10. Exit from the configuration source.

In the next point enter **Input channels** menu and define **logical channel** in the **Profile/timer** mode and select the Profile ("My Profile") that is configured above. Finally, after defining the Logical channel and add to the Group the result should be visible in the display.

The second method is described in section 7.8.10 Examples of Logical Channels configuration in the *Example 7.8.10.9*

7.12. CONTROLLERS

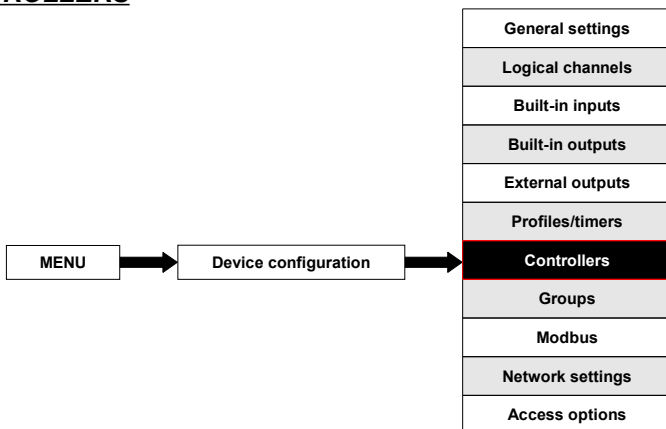

Although most controlling processes can be realised using simple ON - OFF mode, there is sometimes necessity of application of more advanced way of driving the actuators. The MultiCon has implemented **proportional–integral–derivative controllers (PID controllers)** which is a generic control loop feedback mechanism (controller) by calculating an "error" value as the difference between a measured process variable and a desired setpoint. The controller attempts to minimize the error by adjusting the process control outputs. In the system is available 8 independent settings of PID type controllers.

7.12.1. Controllers - general settings

In the system there are **8 independent settings of PID type Controllers** available which can be used by any **Logical channel** switched in **Controller** mode - see **Chapter 7.8.7. Logical Channels settings for Controller mode**.

The window with basic parameters of the **Controller** shown on Fig. 7.89.

Controller:	↓	3	↑
Controller name:	Controller 3		
Mode:	PID		
Dead zone:	0.5		
Controller parameters			
P coefficient:	5		
✓			

Fig. 7.89. Main configuration of an Controller profile



Arrows placed in the upper right corner of the screen allow switching between controllers to configure settings of controller parameters. The middle button allows direct selection of specific controller from the list.

The parameters of **Controllers** are:

- **Name** - to change a name of **Controller** press the button next to the **Name** label,
- **Mode** - in this parameter user can select control mode which is used to controller calculation (algorithm), there are 3 options:
 - **PD** - proportional–derivative mode,
 - **PI** - proportional–integral mode,
 - **PID** - proportional–integral–derivative mode,
- **Dead zone** - this parameter determines how much the process variable must change in relation to its value in the previous cycle before it will be noticed by the controller, it means that the output of the controller will be changed if the difference between **Set point channel** value and **Feedback channel** value (more about **Set point channel** and **Feedback channel** parameters see **Chapter 7.8.7. Logical Channels settings for Controller mode**) exceeds the **Dead zone** value,
- **Controller parameters** parameter block - this block allows the user to set **PID** coefficients:
 - **P coefficient** - in this parameter user enter proportional gain,
 - **I coefficient** - this parameter is available for **PI** and **PID** mode and allows the entry of integral value,
 - **D coefficient** - this parameter is available for **PD** and **PID** mode and allows the entry of derivative value,
 - **Differentiated signal** - this parameter is available for **PD** and **PID** mode and allows the selection of the option (see Fig. 7.90 and Fig. 7.91):
 - ▶ **feedback (measured)** - in this option the value of **Feedback channel** is directly sent to **D term**, which allows the fast response of the device to fast changes with the controlled object,
 - ▶ **error (deviation)** - in this option the value of **Feedback channel** is sent to **D term** after calculation of error output and checking exceeds the range of **Dead zone**, this option is set for slow changes controlled object,
- **Controller output** parameter block - this block has parameters:
 - **Offset** - value of this parameter causes offset of controller output value, **Note!** after offset the output signal the output value is limited to the range set in **Low output limit** and **High output limit** parameters:.,
 - **Low output limit** and **High output limit** - these parameters limit the output range of controller signal,

In Fig. 7.90 shows the block diagram of a control process of an object with the **Controller** implemented in the device. Set the setting of the selected Controller to be connected to the **Logical channel** operating in the **Controller** mode. In this **Logical channel**, select a **Set point channel** and the **Feedback channel**, which store the data required to control the object. Respectively, **Set point channel** contains a destination value of the process, while the **Feedback channel** includes the value of feedback coming from the object controlled. MultiCon uses data collected from these channels and the corresponding Controller controls the object.

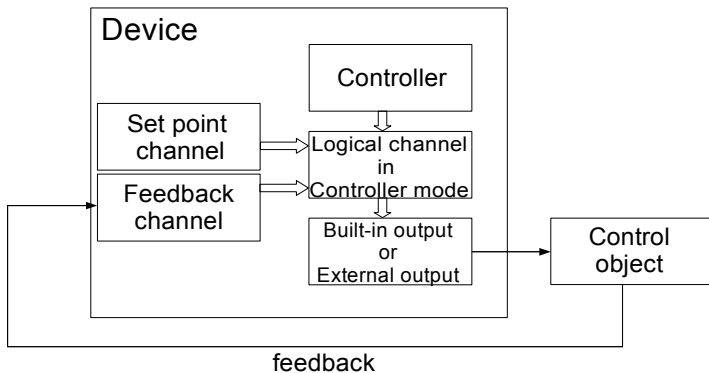

Fig. 7.90. Block diagram of the control loop of the object by MultiCon

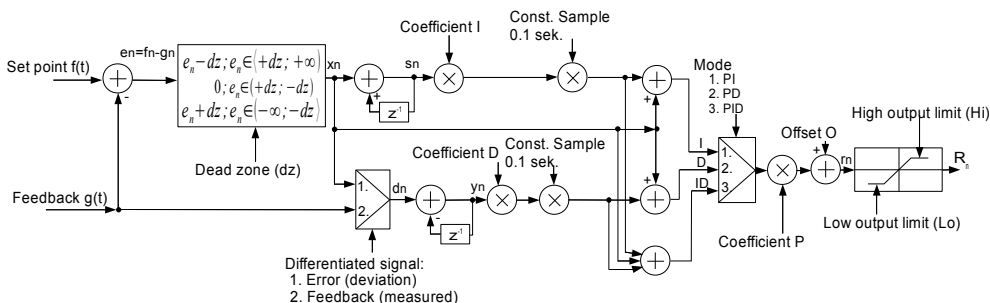

Fig. 7.91. Block diagram of the **Controller** implemented in the device

Overall formula **Controller** output is:

$$r(t) = P \cdot \left[x(t) + \frac{1}{I} \int_0^{\infty} x(t) dt + D \frac{dx(t)}{dt} \right]$$

For the time sampling the formula for **Controller** output is:

$$r_n = P \cdot \left[\underbrace{x_n + \frac{1}{I} \cdot (x_n + s_{n-1})}_{\text{człon całkujący}} + \underbrace{D \cdot (x_n - y_{n-2})}_{\text{człon różniczkujący}} \right]$$

, where:

- P** - controller gain, set by **P** parameter,
- x_n** - error (deviation) the feedback signal relative to setpoint value,
- I** - the integration time, set by **I** parameter,
- s_{n-1}** - integration signal for n-1 sample
- D** - differential time, set by **D** parameter,
- y_{n-2}** - differential signal for n-2 sample

7.12.2. Examples of Controller configurations

Example 7.12.2.1: Application of the Controllers (see Chapter 7.12 CONTROLLERS for more information about the parameters of Controllers)

Task:

Lets assume that we want to configure Controller in the PID mode which controls temperature in the room. The signal from temperature sensor PT100 is connected to Logical channel 1. The **Controller** controls the passive current output generating a signal in the range of 4 to 12mA to control the heater.

Solution:

We enter to the **Device configuration** → **Controllers** menu and using arrows in upper navigation bar select **Controller 1**. Next we set the name e.g. "**Controller**". In the parameter **Mode** we select **PID**. **Dead zone** parameter we set to 0. Next we set the **Controller parameters** block as follows – **P coefficient:** 0.8, **I coefficient:** 0.1, **D coefficient:** 0.05, **Differentiated signal** we select the **feedback (measured)**. However, the **Controller output** block of parameters we set as follows: **Output unit:** mA, Offset: 0, **Low output limit:** 4mA, **High output limit:** 12mA. Exit from the **Controllers** menu.

In the next point enter **Input channels** menu and define **Logical channel 1** using arrows in upper navigation bar, and select **Set point value mode**. Parameter **Name** set to "**Set point**", parameter **Unit** set to °C and in the **Set point value** parameter we enter the value 23. Default displaying mode is **Numeric** format, and it is proper for this purpose, but precision and data limits should be changed – **Precision:** 0.0, **Graph Low:** 15 °C, **Graph High:** 30 °C.

Next we define **Logical channel 2** by setting name "**Room**" and mode: **Hardware input**. Next we can select the source. Assuming that sensor installed in the room is connected to **Physical Input A1** select this input as a source. Next press button **Configure source** to enter hardware configuration. In this panel in the parameter **Mode** select the type of the sensor and connection method **PT100**, next set **Low Limit:** -50°C and **High Limit:** 600°C. Finally exit hardware configuration. Due to we do not need any post processing its both parameters can be disabled (**Scaling:** disabled, **Filter type:** disabled). Default displaying mode is **Numeric** format, and it is proper for this purpose, but we can change **Precision** and extend it by one digit after decimal point. Also lower and upper ends of graph can be changed. Lets say that temperature in room can vary from 15 to 25 degrees, so we can set such range with e.g. 5 deg of margin. (**Graph low = 10.0**, **Graph high = 30.0**).

In the next point define **Logical channel 3** by setting name "**Controller**" and mode: **Controller**. We set **Unit** parameter to mA. In the **Controller num.** parameter select the Controller 1 (1.PID:"Controller"). In the **Set point channel** parameter we set **Logical channel 1**, **Feedback channel** parameter we set to **Logical channel 2**. In the Displaying block of parameters we set **Numeric** format, change **Precision** extend it by one digit after decimal point. We set Graph low: 0 and Graph high to 20.

To control the temperature in the room we need to connect the signal from the controller to appropriate output control e.g. heating. For this purpose we use the Passive current output.

We enter to the **Device configuration** → **Build-in outputs** menu and using arrows or pressing middle button with a number in upper navigation bar select output you want to use e.g. **Output 1**. Next set: **Source:** Logical Channel 3, (then unit of **Input Levels** will be changed automatically to "mA"), **Input Lower level:** 4 mA, **Input Upper level:** 12 mA, **Output Lower level:** 4 mA, **Output Upper level:** 12 mA, **Alarm Level:** 4 mA.

We have defined logical channel and build-in output. To visualise the data, channel must be added to some group.

Using **Configuration menu** enter **Groups** definition, and enable **Group 1 (Group: enabled)**.

Then change its name to e.g. “**Temperature controller**”, and select sources of data to be presented. To do this move window over parameters called **Channels** and set them as follow

Slot 1: Log. ch. 1 “Set point”, Slot 2: Log. ch. 2 “Room”; Slot 3: Log. ch. 3 “Controller”, Slot 4: empty, Slot 5: empty; Slot 6: empty.

After whole configuration exit the menu pressing Save changes, the result should be visible as soon as first measurement is done.

Due to fact that output is passive type, it is required to power the current loop. Schematic is shown in the Fig. 8.12. Note that polarisation of IO2 and IO4 outputs has no matter.

7.13. GROUPS

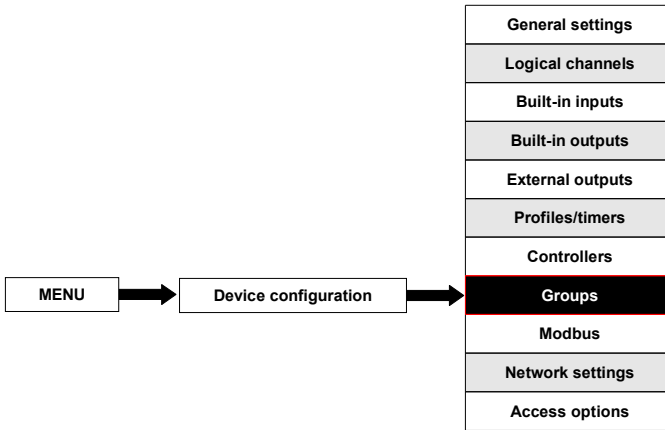

As it was mentioned **Groups** have the sets of 1-6 **Logical Channels** collected together for clearance. To see detailed definition of **Group** see **Chapter 5.1. UNDERSTANDING controller/data recorder MultiCon CMC-99/141**. If the MultiCon has license for data logging then each Group is able to log the data coming from Logical channel included in this Group.

7.13.1. Groups - general settings

In the system there are **10 Groups** available which can be used to display and logging the data from **Logical channels**.



Arrows placed in the upper right corner of the screen allow switching between groups to configure settings of group parameters. The middle button allows direct selection of specific group from the list.

The parameters of **Group** are:

- **Group** - each group can be:
 - **disabled** - after selecting this option, the other parameters are not visible, the **Group = disabled** is not visible when you exit the menu,
 - **enabled**, - for this option the group is active,
- **Display options** parameter block - this block has parameters:
 - **Name** - to rename a group, press the button next to the **Name** label, and then set any name,

- **Charts** - this parameter has option:
 - ▶ **horizontal** - time axis is in horizontal position,
 - ▶ **vertical** - time axis is in vertical position,
- **Bars** - this parameter has option:
 - ▶ **horizontal** - horizontal direction of bars position,
 - ▶ **vertical** - vertical direction of bars position,
- **Line width** - this parameter has option:
 - ▶ **1 pixel** - the char line one pixel width,
 - ▶ **2 pixels** - the char line two pixels width,
 - ▶ **3 pixels** - the char line three pixels width,
- **Time scale** - this parameter has option:
 - ▶ **19 sec.** - time scale of window displaying a graph is 19 sec., the significant graduation is 5 sec.,
 - ▶ **48 sec.** - time scale of window displaying a graph is 48 sec., the significant graduation is 15 sec.,
 - ▶ **95 sec.** - time scale of window displaying a graph is 95 sec., the significant graduation is 25 sec.,
 - ▶ **3 min.** - time scale of window displaying a graph is 3 min., the significant graduation is 50 sec.,
 - ▶ **6 min.** - time scale of window displaying a graph is 6 min., the significant graduation is 95 sec.,
 - ▶ **12 min.** - time scale of window displaying a graph is 12 min., the significant graduation is 190 sec.,
- **Background** - this parameter has option:
 - ▶ **white** - the background of window displaying the chars is white,
 - ▶ **black** - the background of window displaying the chars is black,
- **Channels** parameter block - this block defines the number and location of Logical channels that are displayed in the Group, includes the parameters:
 - **Slot 1**,
 - **Slot 2**,
 - **Slot 3**,
 - **Slot 4**,
 - **Slot 5**,
 - **Slot 6** - in each slot user can select a option:
 - ▶ **disabled** - disabled position is skipped which reduces the number of position to deploy in the display window,
 - ▶ **empty** -the empty position remain empty so that in contrast to the disabled position it doesn't reduce the number of position to deploy in the display window,
 - ▶ selected **Logical channel** from list, user can select 1 from 60 available Logical channel which will be displayed in the specific location on the screen,
- **Logging options** parameter block - logging options are available only in the device having a license for logging the data (for more information about the logging license is in **Chapter 7.4. DEVICE INFORMATION, LICENSE AND FIRMWARE UPDATE**); parametrs of this block shown and described in the **Chapter 7.13.2. Groups - Logging options**.

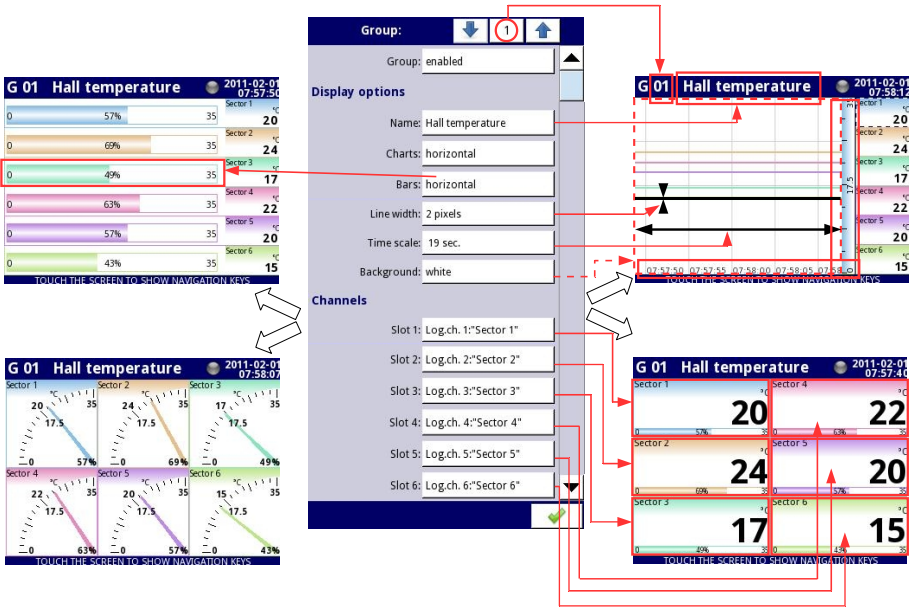

Fig. 7.92. Sample of **Group** parameters settings - all Slot set to **Logical channel**

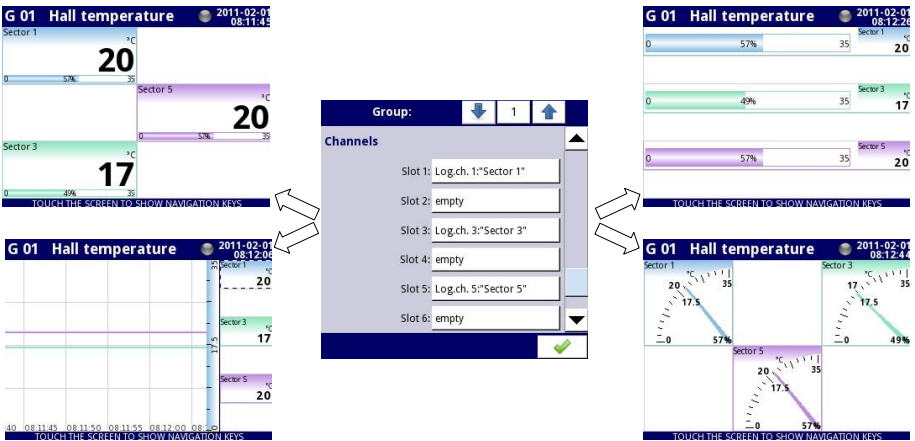

Fig. 7.93. Sample of **Group** parameters settings - Slots set to **Logical channel** and set to **empty**

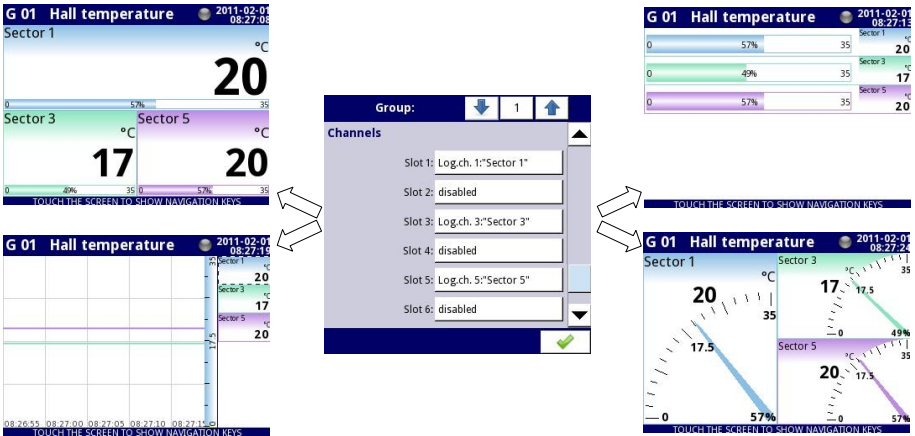

Fig. 7.94. Sample of **Group** parameters settings - Slots set to **Logical channel** and set to **disabled**

7.13.2. Groups - Logging options

Logging options are available only in the device having a license to log the data (for more information about the logging license is in **Chapter 7.4. DEVICE INFORMATION, LICENSE AND FIRMWARE UPDATE**). To log the data from the Logical Channel should be:

- **Logical channel** attached to **Group** using the **Channels** parameter block,
- **enable** the data logging by setting the options in block of parameters -> **Logging options**,
- after exiting the menu accept the changes by **writing configuration**,
- received logging data files can be sent to flash drive (form more information about files management see **Chapter 7.3. FILES MANAGEMENT**)

Each Group has its own data logging options and the MultiCon can log the 10 independent Groups of Logical channels at the same time .

Logging of the data in the device is hardware limited, so the producer recommends to limit the logging to less than 200 samples per second (e.g. at the maximum sampling frequency of 0.1 sec. user should not log more than 20 Logical channels at one time). Failure to comply with these restrictions may cause the device to slow down .

Logging options parameter block has the following parameters:

- **Mode** - this mode has options:
 - **disabled** - logging of selection Group is disabled,
 - **always** - logging is continuous in time,
 - **from logical channel** - this option activate new parameter - **Triggering source** which enabled logging the data when the value of **Triggering source** > 0,
- **Triggering source** - this parameter is visible for **Mode=from log.channel**, when value of this source > 0 than the **data logging is enabled**,
- **Description** - user can set a description of a data logging file by pressing the button

- next to the **Description** label and then setting any text, (in Fig. 7.20 are shown examples of descriptions of any logging files),
- **Base period** and **Base unit** - this parameters set duration of the sample of data logging, these parameters have the following options:
 - **unit: second** -> duration form **0.1** to **3600 sec.**,
 - **unit: minute** -> duration form **0.1** to **1440 minute**,
 - **unit: hour** -> duration form **0.1** to **24 hour**,
 - **Alternative mode** - this mode allows the user to log data in special situation where a deeper analysis is required (for example in critical state of object),this parameter has the following options:
 - **disabled** - alternative logging of selection Group is disabled,
 - **from logical channel** - this option activate new parameter - **Triggering source** which enabled logging the data when the value of **Triggering source** > 0,
 - **Alternative source** - this parameter is visible for **Mode=from log.channel**, when value of this source > 0 than the **data logging** for alternative mode is **enabled**,
 - **Alternative period and Alternative unit** - this parameters set duration of the sample of data logging for alternative mode, these parameters have options:
 - **unit: second** -> duration form **0.1** to **3600 sec.**,
 - **unit: minute** -> duration form **0.1** to **1440 minute**,
 - **unit: hour** -> duration form **0.1** to **24 hour**,

Fig. 7.95. The Logging options block parameters



For any changes to the settings of the configuration of logging Group (e.g. a change in the logging parameters, changing parameters of **Display options** parameter block or change parameters of Logical channel included in logging Group) creates a new logging file. If user shuts down the device or changes other parameters independent of logging Group new logging file is not created.

7.13.3. Groups - Examples of visualisations of groups

Example 7.13.3.1: Single channel - one big needle.

If user needs to visualise single hardware input value it is necessary to define one **Logical channel** and one **Group** with one active channel. Moreover to show incoming data as a single big needle (Fig. 7.96) it is necessary to disable all unused visualisation slots in a

Group. Of course other presentation modes are also available, to switch between modes use [MODE] buttons in **Navigation bar**.

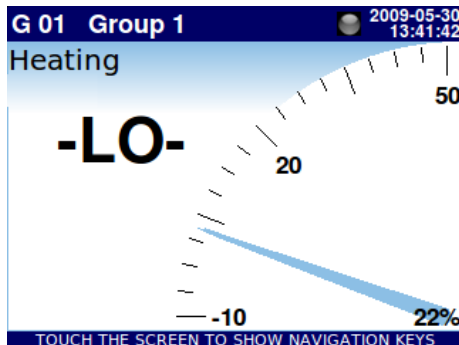

Fig. 7.96. Single big needle example

Example 7.13.3.2: Three channels view - one bigger, two smaller

If some measured parameters are more important than others, there are some ways to emphasize them. Let's assume then the pressure in some chamber is the key parameter, and temperature and humidity are less important. The process of **MultiCon CMC-99/141** configuration starts with the definition of 3 **Logical Channels** – one for every parameter. Their sources should be in this example **Hardware inputs** with appropriate scaling and definition of units. Defined channels should be collected into one group. The key matter for the desired presentation is the configuration of slots sources in the group.

Example view of the assumed problem is shown in Fig. 7.97. To get such results, the slots of the group should be set as follows:

- Slot 1:** Log. ch. 7 "Pressure";
- Slot 2:** disabled;
- Slot 3:** disabled;
- Slot 4:** Log. ch. 9 "Temperature";
- Slot 5:** Log. ch. 1 "Humidity";
- Slot 6:** disabled.

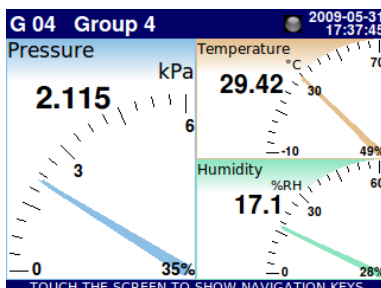
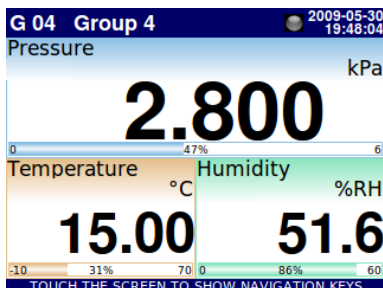
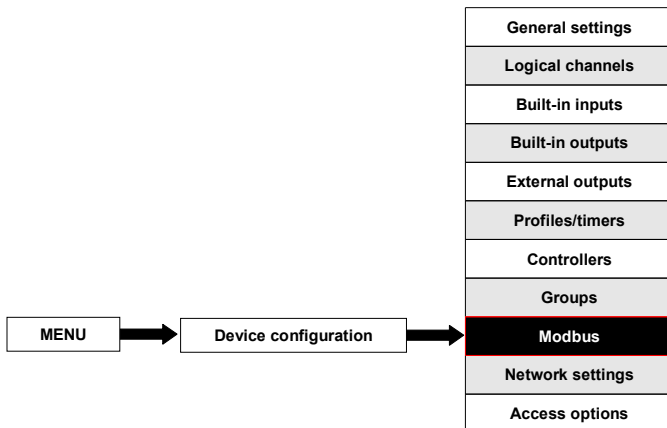

Fig. 7.97. Example of three channels presentation with emphasis of Pressure

Switching between modes it is noticeable that position of particular channels can slightly vary. It is caused by aspect of different modes – their position is selected in that way to obtain elements of particular data panels as big as possible.

7.14. MODBUS



The basic version of MultiCon has one RS-485 port built-in. The ability of communication can be increased by installing a communication module into slot D of the device (Fig. 7.98). This module offers 2 additional serial ports (one RS-485, and one RS-485/RS-232), which allows the creation of an advanced Multi-Modbus system. In the current software version, a MODBUS RTU protocol only is available and every port can be switch to Slave or Master mode.

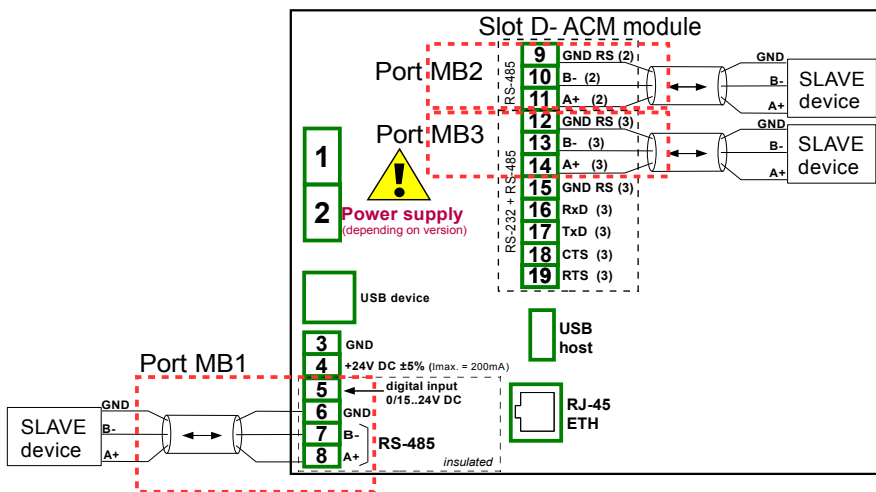

Fig. 7.98. Serial communication ports available in the device

7.14.1. Modbus - general settings

Window with basic parameters of communication interfaces is shown in Fig. 7.99.

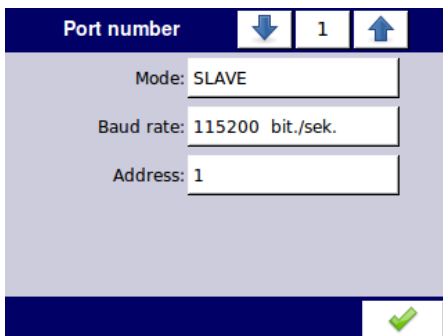
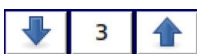

Fig. 7.99. Configuration parameters for **SLAVE** mode



Arrows placed in the upper right corner of the screen allow switching between available serial ports. The middle button can be used for direct selection of a specific communication port from the list.

Parameter common for all Modbus protocol modes is:

- **Mode** - which has option:
 - **disabled**, the selected Modbus port is inactive,
 - **SLAVE** - this device is SLAVE device, see **Chapter 7.14.2 Modbus - SLAVE mode**,
 - **MASTER**, this device is MASTER device and manages the Slave devices, see **Chapter 7.14.3. Modbus - MASTER mode**

7.14.2. Modbus - SLAVE mode

Parameters of Modbus protocol for SLAVE mode are:

- **Mode = SLAVE**,
- **Baud rate** - this parameter allows to the selection a baud rate RS-485 interface, available option: 1200, 2400, 4800, 9600, 19200, 38400, 57600, 115200 bit./sec.,
- **Format** - data format of RS-485 interface, available options:

Format	Number of data bits	parity control	Number of stop bits
8N1	8	N - none	1
8N2	8	N - none	2
8E1	8	E - even	1
8E2	8	E - even	2

Format	Number of data bits	parity control	Number of stop bits
8O1	8	O - odd	1
8O2	8	O - odd	2

- **Address** - SLAVE device address, available address range: 1÷255,

In this mode the device parameters and measurement result are available via RS-485 interface, as HOLDING-type registers of Modbus RTU protocol. The registers (or groups of the registers) can be read by 03h function, and written by 06h (single registers) or 10h (group of the registers) accordingly to Modbus RTU specification. See **Chapter 7.14.2.1. Modbus SLAVE - The Modbus protocol handling** for detailed description of MODBUS protocol handling in MultiCon device.

7.14.2.1. Modbus SLAVE - The Modbus protocol handling

Transmission parameters: 1 start bit, 8 data bits, 1 stop bit, no parity control

Baud rate: selectable from: 1200 to 115200 bits/second

Transmission protocol: MODBUS RTU compatible

7.14.2.2. Modbus SLAVE - List of registers

The device parameters and measurement result are available via RS-485 interface, as HOLDING-type registers of Modbus RTU protocol. The registers (or groups of the registers) can be read by 03h function, and written by 06h (single registers) or 10h (group of the registers) accordingly to Modbus RTU specification.

Register	Write	Range	Register description
20h	No	0÷199	Address of device
21h	No	2050h, 2060h	Device identification code 2050h - device in big housing (5.7" display), 2060h - device in small housing (3.5" display).
Measurements results (floating point format) ¹			
200h	No	0÷0FFFFh	Measurement result for logical channel 1 (high word)
201h		0÷0FFFFh	Measurement result for logical channel 1 (low word)
202h	No	0÷0FFFFh	Status for logical channel 1: 0h - data valid, 1h - data not ready, 20h - software error, 40h - bottom border of the software measurement range is exceeded, 80h - top border of the software measurement range is exceeded, 2000h - hardware error, 4000h - bottom border of the hardware measurement range is exceeded, 8000h - top border of the hardware measurement range is exceeded, FFFFh - data not available (e.g. logical channel not configured)
203h	No	0÷6	Decimal point for logical channel 1
Register from 204h to 2F0h			Measurement results, status and decimal point for Logical Channels 2÷60

Register	Write	Range	Register description
Measurements results (integer format) ¹			
400h	No	0÷0FFFFh	Measurement result for logical channel 1 (high word, not considering the decimal point)
401h	No	0÷0FFFFh	Measurement result for logical channel 1 (low word)
402h	No	0÷0FFFFh	Status for logical channel 1: 0h - data valid, 1h - data not ready, 20h - software error, 40h - bottom border of the software measurement range is exceeded, 80h - top border of the software measurement range is exceeded, 2000h - hardware error, 4000h - bottom border of the hardware measurement range is exceeded, 8000h - top border of the hardware measurement range is exceeded, FFFFh - data not available (e.g. logical channel not configured)
403h	No	0÷6	Decimal point for logical channel 1
Register from 404h to 4F0h			Measurement results, status and decimal point for Logical Channels 2÷60

¹ IEEE 754 standard, Float point format represents data as precision as possible. Integer 32 represents value with constant precision, selected by decimal point position. When decimal is set for example 0.0 then Int32 format represents integer part of the value contained in float registers and multiplied by 10 (e.g.: float is 1.2345, D.P. = 0.0, then Integer = 12). Similarly when decimal point is 0.000 then integer represents integer part of the value contained in float registers and multiplied by 1000 (e.g.: float is 1.2345, D.P = 0.0, then Integer = 1234)

7.14.2.3. Modbus SLAVE- Transmission errors handling

If during reading or writing one of registries an error occurs then the unit shall return the frame containing the error code (according to the Modbus protocol).

Error codes should be interpreted as follows:

- 01h** - illegal function (only functions 03h, 06h and 10h are available),
- 02h** - illegal register address
- 03h** - illegal data value

7.14.2.4. Modbus SLAVE- Example of query/answer frames

The examples concern a unit with address 1. All values are given in the hexadecimal system.

Designations:

- ADDR** Address of the device in the system
- FUNC** Function number
- REG H,L** Higher and lower part of registry number, to which the command refers to
- COUNT H,L** Higher and lower part of registry counter number, to which the command refers
- BYTE C** to, starting with the register, which is defined by REG (max. 32)
- DATA H,L** Number of higher bytes in the frame
- CRC L,H** Higher and lower part of data word
- Higher and lower part of CRC sum

1. Read of ID code

ADDR	FUNC	REG H,L		COUNT H,L		CRC L,H	
01	03	00	21	00	01	D4	00

The answer:

ADDR	FUNC	BYTE C	DATA H,L		CRC L,H	
01	03	02	20	60	A1	AC

DATA H,L - identification code (2060h)

4. Read of the registers 401h, 402h and 403h in one message (example of reading a number of registries in one frame):

ADDR	FUNC	REG H,L		COUNT H,L		CRC L,H	
01	03	04	01	00	03	55	3B

COUNT L - the count of being read registers (max. 32)

The answer:

ADDR	FUNC	BYTE C	DATA H1,L1		DATA H2,L2		DATA H3,L3		CRC L,H	
01	03	06	00	0A	00	02	00	00	18	B4

DATA H1, L1 - 401h registry (10 – high word of value for channel 1, no decimal point),
 DATA H2, L2 - 402h registry (2 – low word of value for channel 1, no decimal point),
 DATA H3, L3 - 403h registry (0 – status for channel 1).



There is no full implementation of the Modbus Protocol in the device. The functions presented above are the only available.

7.14.3. Modbus - MASTER mode

The parameters of a Modbus protocol for MASTER mode are:

- **Mode = MASTER,**
- **Baud rate** - this parameter allows the user to select baud rate RS-485 interface, available option: 1200, 2400, 4800, 9600, 19200, 38400, 57600, 115200 bit./sec.,
- **Request timeout** - is the amount of time (any value between 0.01 to 3 sec.) the master device waits for a response from the Slave device after sending a query,
- **Request retrials** - this is the number of times (integer value between 1 to 5) a Master device tries to send a message,
- **Slave device** - this Button enters submenu allows to define the list of Slave devices

connected to the current serial port of MultiCon and configure registers for read and/or write. See below for more informations about this menu.

- **Reg. num. displaying** - this parameter allows to change mode of displaying the Register addresses for **Logical channel** and **External output** menu. Two formats are available:
 - **hexadecimal** - the registers are displayed in hexadecimal format. To indicate that data has a hexadecimal format, the letter 'h' is added at the end - for example, 12h (0x12),
 - **decimal** - the registers are displayed in decimal format (without any marker) e.g. 123

Slave device menu .

MultiCon allows to address as many as 255 slave devices on the addresses from 1 to 255. The Idea of SLAVE devices menu is based on defining the devices connected to the MASTER on a specific addresses. To define external data source, first an address must be chosen, next further parameters of the SLAVE device (having this address) set.



Arrows placed in the upper right corner of the screen allow switching between addresses of SLAVE devices to define or modify the settings of Slave devices in specific address. The middle button allows direct selection of specific address from the list.

If the particular address is not used, then a *short menu* is displayed:

- **Device type** which has the following options:
 - **not present** - means that this address is not used (in other words - there is no SLAVE device with this address connected),
 - **defined** - after selecting this option an extended list of SLAVE device parameters will appear, see below for details
- **Load device template**, this button allows the loading a template with predefined blocks of input and / or output registers. Pressing this button invokes a file selection window (Fig 7.100). After successful loading of the template an extended list of SLAVE device parameters will appear, see below for details. Templates can be imported into the MultiCon using a **File Management** menu and also created by the user using **Save device template** button after fully configuration of a slave device.

If the **Device type** is set to **defined** or a Template has been loaded, then extended SLAVE device menu is shown. This menu as following fields:

- **Device type = defined**,
- **Device name** - to create or change the name of a SLAVE device, press the button next to the **Device name** label and enter the name using displayed editor,
- **Device templates** parameter block – see **Chapter 7.14.3.1** for extended description,
- **Device channels** parameter block - see **Chapter 7.14.3.2** for extended description,
- **Register blocks** parameter block - see **Chapter 7.14.3.3** for extended description,

7.14.3.1. Modbus MASTER - Device templates parameter block

This block is composed of 2 buttons:

- **Load device template** - function is the same as presented in short menu description
- **Save device template** - allows the user to save a configured SLAVE device as

a template for further usage. Saved template can be used for:

- ▶ fast copying/moving of the SLAVE device to another address (use **Load device template**)
- ▶ easy creation of similar SLAVE devices by loading the template in another address and modification of parameters.
- ▶ easy moving exchange of templates between different MultiCon devices (using **File Management** menu).

An example of Modbus template selection window is shown in Fig. 7.100. Below this figure additional icons are described.



Fig. 7.100. Template selection window



This button invokes software keyboard window allowing write or search the template name.



This button allows the user to delete selected template.



Navigation keys allows the user to select appropriate template.

7.14.3.2. Modbus MASTER- Device channels parameter block

This block includes following buttons:

- **Input list** – this button runs submenu related to the Inputs of SLAVE device
- **Output list** – this button runs submenu related to the Outputs of SLAVE device

Both these submenus has basic icons presented below. Their functions are as follow:



This button allows the user to add a new Input/Output to Input list / Output list,



This button allows the user to delete the Input/Output from Input list / Output list



Arrows placed in the upper right corner of the screen allows user to switch between Inputs/Outputs. The middle button moves directly to specific Input/Output channel selected from the list.

Input List sub-menu.

When at least one Input Channel is added to the **Input list**, then an Input channel menu is displayed. This menu consist of following fields:

- **Channel value** parameters block composed of buttons:
 - **Value register** - by pressing the button next to the **Value register** label, the user goes to the menu where the details of the Modbus register serving data of input being can be set,
 - **Decimal point** - pressing of the button next to **Decimal point** label a list of available decimal point positions appears, in a last place there is an option: *** exp (-point register)**. Selecting this value a new field (**Decimal point register**) will appear in the **Channel value** block.
 - **Decimal point register**, this parameter appears when the **Decimal point** parameter is set to *** exp (-point register)** option and allows the user to select the SLAVE device's register containing information about decimal point position. Using this parameter, the **Channel value** is being displayed according to formula:

$$(data\ of\ Value\ register) \cdot 10^{(-Decimal\ point\ register)}$$

- **Channel status '-HI-'** parameter block, gathers parameters defined when a status **-HI-** should be displayed (returned) in a place of numerical value of Input Channel. In this block a following parameters can be displayed
 - ➔ **-HI- state** - it has 3 options:
 - ✓ **never** – do not display status **'-HI-'**; for this option, other parameters of **Channel status '-HI-'** block are invisible,
 - ✓ **if register = value** - state **'-HI-'** is returned if data read from **'-HI- register'** equals to **'-HI- value'** parameter,
 - ✓ **if register ≠ value** - state **'-HI-'** is returned if data read from **'-HI- register'** differs from **'-HI- value'** parameter,
 - **-HI- register** - allows the user to select a status register to be read (see above)
 - **-HI- value** - allow the user to define the value being returned corresponding to status **-HI-** (see above)
- **Channel status '-LO-'** parameter block, gathers parameters defining status **-LO-**:
 - **-LO- state** - it has 3 options:
 - ▶ **never** – do not display status **'-LO-'**; For this option, other parameters of **Channel status '-LO-'** block are invisible,
 - ▶ **if register = value** - state **'-LO-'** is returned if data read from **'-LO- register'** equals to **'-LO- value'** parameter,
 - ▶ **if register ≠ value** - state **'-LO-'** is returned if data read from **'-LO- register'** differs from **'-LO- value'** parameter,

- **-LO- register** - allows to select a status register to be read (see above)
- **-LO- value** - allow to define value returned corresponding to status **-LO-** (see above)

- **Channel status '-WAIT-'** parameter block, gathers parameters defined when a status **-WAIT-**
 - **-WAIT- state** - it has 3 options:
 - ▶ **never** – do not display status **'-WAIT-'**; For this option, other parameters of **Channel status '-WAIT-'** block are invisible,
 - ▶ **if register = value** - state **'-WAIT-'** is returned if data read from **'-WAIT-register'** equals to **'-WAIT- value'** parameter,
 - ▶ **if register ≠ value** - state **'-WAIT-'** is returned if data read from **'-WAIT-register'** differs from **'-WAIT- value'** parameter,

 - **-WAIT- register** - allows the user to select a status register to be read (see above)
 - **-WAIT- value** - allows the user to define value returned corresponding to status **-WAIT-** (see above)

- **Channel status '-ERR-'** parameter block , gathers parameters defining when a status **-ERR-**
 - **-ERR- state** , - it has 3 options:
 - ▶ **never** – do not display status **'-ERR-'**; For this option, other parameters of **Channel status '-ERR-'** block are invisible,
 - ▶ **if register = value** - state **'-ERR-'** is returned if data read from **'-ERR-register'** equals to **'-ERR- value'** parameter,
 - ▶ **if register ≠ value** - state **'-ERR-'** is returned if data read from **'-ERR-register'** differs from **'-ERR- value'** parameter,

 - **-ERR- register** - allows the user to select a status register to be read (see above)
 - **-ERR- value** - allows the user to define value returned corresponding to status **-ERR-** (see above)



When a **Logical channel** is configured to **Modbus** mode then while reading the registers from SLAVE device if connection to the SLAVE device is lost, the device returns an error and displays the state **-ERR-**.

Output list sub-menu

This submenu allows the user to edit the output channels registers to be written. When at least one Output Channel is added to the list, then an Output channel menu is displayed.

The parameters of the **Output channels** are:

- **Output active** ,
 - ▶ **no** - the output channel is defined but invisible in the **External output** menu,
 - ▶ **yes** - the output channel is defined and visible in the **External output** menu

Channel value parameter block – gathers following fields:

- ◆ **Control type**
 - ▶ **as a relay** - the output has two state, low state: value '0' and high state: maximal value (for 16-bit format is the value 65535),
 - ▶ **as a linear output** - can take any value depending of the settings in **Output register** and settings the parameters in the **External outputs** menu,
- **Output register** sub-menu - by pressing the button next to the **Output register** label user goes to the menu where user can set details of the Modbus register to be written.

The submenu of **registry** settings in the Modbus protocol has the following fields:

- **Register type**, this parameter is only for the register settings in the **Input list** menu (for the **Output list** menu the registers are HOLDING type), a user can select two types:
 - ▶ **HOLDING** - holding registers of SLAVE device compatible with Modbus protocol
 - ▶ **INPUT** - input registers of SLAVE device compatible with Modbus protocol
- **Register number** - any value from 0 to 65535
- **Data format**, we can select one of these options:
 - ▶ **16 bits, signed** - integer value, the most significant bit is the sign bit,
 - ▶ **16-bits, unsigned** - integer value without information about the sign,
 - ▶ **32 bits, signed**, integer value, the most significant bit is the sign bit,
 - ▶ **32-bits, unsigned** - integer value without information about the sign,
 - ▶ **32 bits, float**, floating point IEEE 754 format,
 - ▶ **16-bits, BCD**, unsigned BCD value, write two digits in each byte,
 - ▶ **32-bits, BCD**, unsigned BCD value, write two digits in each byte,
- **32 bit reading**, this parameter is only for 32-bit format, user can select one of these options:
 - ▶ **two 16-bit registers**,
 - ▶ **one 32-bit register**
- **Ordering** - this parameter is only for 32-bit formats, the letters ABCD means: A - most significant byte of high words (word = 2 bytes), B - least significant byte of the high words, C - most significant byte of low words, D - least significant byte of the low words
 - ▶ **ABCD (standard)**
 - ▶ **CDAB**,
 - ▶ **DCBA**,
 - ▶ **BADC**,

- **Data shift** - values can be bit moved to the right any integer value in the range:
 - ▶ for 16-bit format from 0 to 15,
 - ▶ for 32-bit format from 0 to 31, shift not exist for float format,
- **Data mask**, the device allows the user to use the masking of data on individual bits, mask 0xFFFF for 16-bit format is means that the entire value of register is visible, while the 0x0 mask (no mask) means that the value is zero,

7.14.3.3. Modbus MASTER- Register blocks parameter block

The device has the ability to read data from the SLAVE devices using multi register queries. By default this feature is configured automatically, but can be switched to manual mode.

Resgiter blocks group has following fields:

- **Blocks config. mode**
 - ▶ **automatic** - the device automatically creates a blocks of registers to be read using the list defined in **Device channels** sub-menu. Then the **Block list** is informal only and cannot be edited.
 - ▶ **manual** - user must create a list of registers blocks using **Block list** parameter
- **Maximum block size** - occurs only for the **Blocks configuration mode = automatic**. This parameter allows user to limit number of data registers to be read at once. It can be very useful when SLAVE devices has a limitation of max number of registers read in a single frame.
- **Block list** (invokes informal screen in **automatic** mode and a sub-menu in **manual** mode),

Block list Sub-menu



This button appears only for manual configuration mode and allows the user to add a new block of registers to list of register blocks.



This button appears only for manual configuration mode and allows the user to remove the block of registers from the list of register blocks.



Arrows placed in the upper right corner of the screen allow switching between register blocks. Middle button allows direct selection of a specific register block.

To the **Block list** parameters are:

- **Block type** - defines the function used for data reading/writing, can be set to:
 - ▶ **read Holding register** - register or group of registers read by **03h** function,
 - ▶ **read INPUT register** - register or groups of of registers read by the **04h** function,
 - ▶ **write HOLDING register** - preset single register by the **06h** function and

- preset multiple registers by the **10h** function,
- **Register size** - defines data size, can be set to:
 - ▶ **16-bit registers** - data is read/preset as 16 bit registers; this value can be also used for 32-bit registers reading/preseting. In a such case data is composed as two 16-bit registers and params: **First register & Last register** must select a minimum of 2 registers (e. g. **First register: 3h, Last register: 4h**). The important parameter is then also **Ordering** - see the Chapter 7.14.3.2)
 - ▶ **32-bit registers** - for 32-bit registers reading/preseting only, data is read as one 32-bit register.
- **First register** - value indicating the number of the first register of the block,
- **Last register** - value indicating the number of the last register of the block, for single block with one 16-bit register the parameter **First register** and **Last register** must be the same number register,



Manual mode configuration of registers blocks introduces a freedom when setting **Block list** parameters. Take care to set **Block list** parameters according to **Input list** and **Output list** in **Device channels** parameter block of the device (see above in this Chapter). If user creates a block of registers to read / preset in which there were not registers appearing on the Input list and Output list in the **Device channels** parameter this device in the case of:

- read - the read whole register block and registers undefined in Input list menu will not be visible in the Logical channel in Modbus mode which cannot be read either a data from this registers and to use this registers to control and regulating process,
- preset - will send the frame to preset the entire block of registers and registers which not defined in the **Output list** will not appear on the **External output** menu Warning! in this case to Slave devices will be sent to a random value of these registers, uncontrolled by the user,

7.14.4. Modbus - Register settings

The submenu of **registry** settings in the Modbus protocol has the following fields:

- **Register type**, this parameter is only for the register settings in the **Input list** menu (for the **Output list** menu the registers are HOLDING type), a user can select two types:
 - ▶ **HOLDING** - holding registers of SLAVE device compatible with Modbus protocol
 - ▶ **INPUT** - input registers of SLAVE device compatible with Modbus protocol
- **Register number** - any value from 0 to 65535
- **Data format**, we can select one of these options:
 - ▶ **16 bits, signed** - integer value, the most significant bit is the sign bit,
 - ▶ **16-bits, unsigned** - integer value without information about the sign,

- ▶ **32 bits, signed**, integer value, the most significant bit is the sign bit,
- ▶ **32-bits, unsigned** - integer value without information about the sign,
- ▶ **32 bits, float**, floating point IEEE 754 format,
- ▶ **16-bits, BCD**, unsigned BCD value, write two digits in each byte,
- ▶ **32-bits, BCD**, unsigned BCD value, write two digits in each byte,
- **32 bit reading**, this parameter is only for 32-bit format, user can select one of these options:
 - ▶ **two 16-bit registers**,
 - ▶ **one 32-bit register**
- **Ordering** - this parameter is only for 32-bit formats, the letters ABCD means: A - most significant byte of high words (word = 2 bytes), B - least significant byte of the high words, C - most significant byte of low words, D - least significant byte of the low words
 - ▶ **ABCD (standard)**
 - ▶ **CDAB**,
 - ▶ **DCBA**,
 - ▶ **BADC**,
- **Data shift** - values can be bit moved to the right any integer value in the range:
 - ▶ for 16-bit format from 0 to 15,
 - ▶ for 32-bit format from 0 to 31, shift not exist for float format,
- **Data mask**, the device allows the user to use the masking of data on individual bits, mask 0xFFFF for 16-bit format is means that the entire value of register is visible, while the 0x0 mask (no mask) means that the value is zero,

7.14.5. Modbus - Example of Modbus protocol configuration in the device

Example 7.14.5.1: Input configuration of Modbus protocol in MASTER mode

Task:

This example shows how to configure the **Input channel** to read the registers of SLAVE devices (eg temperature converters). Read the **Register 1** that returns the temperature, **Register 3** is a decimal point register and **Register 2** is a status register. Devices: **Slave device 1** and **Slave devices 2** are set to address **1** and **8**, respectively and have baud rate: 9600 bit/sec. MultiCon as Master has settings as: **Request timeout:** 0,2 sec. and **Request retrials:** 3. For Modbus configuration setting for two same devices may be helpful Modbus template that will be created in this example.

Solution:

First configure the device then connect the SLAVE device to the device (in accordance with

Fig. 7.101).

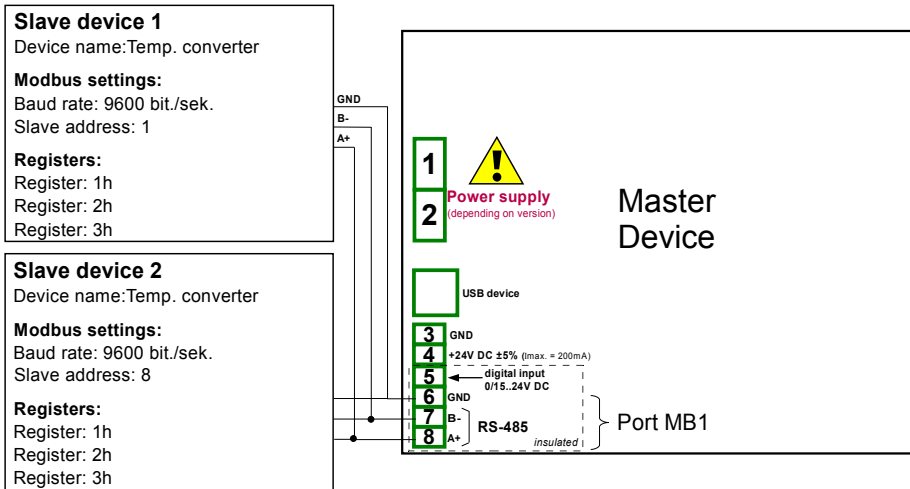

Fig. 7.101. Connection diagram for the Modbus port MB1

Description of the register of SLAVE device shown below in the table

Register	Range	Register description
01h	-4000 ÷ +8500	The temperature measured with a resolution given to 2 decimal places (in the U2 code, excluding decimal point, for example, the value of 3523 means the temperature of 35.23°C)
02h	00h, 10h, 20h,40h, 80h	Status of the temperature, contains the error code, which must be interpreted as follows: 00h - measuring correctly 10h - flooding the interior of the sensor 20h - damage temperature sensor 40h - measured temperature is lower -40°C 80h - measured temperature is upper 85°C
03h	0÷2	Specify the decimal point as a result, the value of 2 means that a point precedes the last 2 digits, the value of 0 means no decimal point

To read the values sent by RS-485 interface the user needs:

To be able to read the value sent by RS-485 include:

- touching the screen and press the **Meningu** button, then press the **Device configuration** button and entering the Modbus menu,
- using the arrows in the upper right corner to select the communication port, such as 1 (**Port number**: 1, MB1 in accordance with Fig. 7.101)
- Select **Mode = Master**, because communication with SLAVE devices to read the registers
- set the baud rate, the same as the slave devices - 9600 bit. / sec.,
- set the **Request timeout**: 0.2 sec.,

- set the **Request retries: 3**,
- press the **SLAVE devices** button to configure the SLAVE devices:
 - in the upper right corner using the arrow keys to select the SLAVE device address, in the case of this example the **Modbus address: 1**,
 - select **defined** in the **Device type** parameter,
 - enter the **Device name: Temperature converter**,
 - skip **Device templates** parameter block because we have not defined any templates,
 - in the **Device channels** parameter block press the **Input list** button to define the register to read,
 - ▶ if the **Input list** is empty, press the sign '+' to add input channel (if the list has defined the input channels use the arrows in the upper right corner to select the input channels)
 - ▶ in the **Value register** parameter set:
 - **Register type: HOLDING** - using **03h** function to read the holding registers as specified by the Modbus RTU,
 - **Register number: 1h** - the number of the read register
 - **Data format: 16 bits, signed** - the choice of format depends on SLAVE device register format,
 - **Data shift: 0**, because we do not want to move data read from Slave device,
 - **Data mask: 0xFFFF**, which reads the whole value of register, exit the **Value register** parameter menu,
 - ▶ in the **Decimal point** parameter select option: * exp (-point register) causes that will be appear a new parameter to appear - **Decimal point register** that casues an automatic change of decimal point, depending on value of **Decimal point register**,
 - ▶ in the **Decimal point register** parameter set:
 - **Register type: HOLDING**,
 - **Register number: 3h**,
 - **Data format: 16 bits, unsigned**,
 - **Data shift: 0**,
 - **Data mask: 0x0003**, because the interest to us only the firsis t 2 bits changing register value, the value of which determines the decimal point, exit after the settings this menu,
 - in the **Channel status '-HI-'** parameter block select option: **if register = value** in the **-HI- state** parameter, which will cause two new parameters: **-HI- register** and **-HI- value**, which were the cause, in the case of equality of values of these parameters the value in place of **Value register** will be located state **-HI-**,
 - ▶ in the **-HI- register** parameter set:
 - **Register type: HOLDING**,
 - **Register number: 2h**,
 - **Data format: 16 bits, unsigned**,
 - **Data shift: 0**,
 - **Data mask: 0x0080**, because we are only interested in changing the value of 8-bit, which in the case of value: '1' indicates over-range temperature converter used in this example, after selecting the settings of this menu, exit the **-HI- register** parameter,
 - ▶ in the **-HI- value** parameter for the signal **-HI-** set the value of **0x0080**,
 - in the **Channel status '-LO-'** parameter block select option: **if register = value**

- in the **-HI- state** parameter, which will cause two new parameters: **-HI- register** and **-LO- value**, which were the cause, in the case of equality of values of these parameters the value in place of **Value register** will be located state **-LO-**,
- ▶ in the **-LO- register** parameter set:
 - **Register type: HOLDING,**
 - **Register number: 2h,**
 - **Data format: 16 bits, unsigned,**
 - **Data shift: 0,**
 - **Data mask: 0x0040,** because we are only interested in changing the value of 7-bit, which in the case of value: **'1'** indicates over-range temperature converter used in this example, after selecting the settings of this menu, exit the **-LO- register** parameter,
 - ▶ in the **-LO- value** parameter for the signal **-LO-** set the value of 0x0040,
 - ▶ skip the **Channel status '-WAIT-'** parameter block leaving the **-WAIT- state** parameter to the option: **never**,
 - in the **Channel status '-ERR-'** parameter block select option: **if register ≠ value** in the **-ERR- state** parameter, which will cause two new parameters: **-ERR- register** and **-ERR- value**, which were the cause, in the case of no equality of values of these parameters the value in place of **Value register** will be located state **-ERR-**,
 - ▶ in the **-ERR- register** parameter set:
 - **Register type: HOLDING,**
 - **Register number: 2h,**
 - **Data format: 16 bits, unsigned,**
 - **Data shift: 0,**
 - **Data mask: 0x00C0,** because we are only interested in changing all the values except the 7, 8 bits, which in the case of the value no being equal to **'0'** indicates error code, after selecting the settings of this menu, exit the **-ERR- register** parameter,
 - ▶ in the **-ERR- value** parameter for the signal **-ERR-** set the value of 0x0000,
 - ▶ exit from the Input list menu, don't enter into the Output list menu, because we only read the register in accordance with the contents of the exercise,
 - move to the **Register blocks** parameter block, set the **Blocks configuration mode** parameter to **automatic** mode,
 - The **Maximum block size** parameter set to eg 5, because the slave device selected in this example allows reading frame (using the Modbus function 03h) with up to 5 registers,
 - this device automatically creates a block of registers (creates one block of 3 registers), the structure of block can see by pressing the **Block list** button, after creating the configuration of the Modbus register to read registers from SLAVE device can be saved by the Modbus settings by saving a Modbus template,
 - move to the parameter block device templates and press the button **Save Template**
 - move to the **Device templates** parameter block and press the button **Save device template**,
 - ▶ in the **Save device template** menu, enter the template name, eg **'Temperature converter'** (stored template can be used to configure the device to a different address),
 - by arrows in the upper right corner of the screen, go to the Modbus address: 8,
 - in the Modbus address: 8 - skip **Device type** parameter, and press the **Load**

- **device template** button and in the template list select the template that has just been saved with the name '**Temperature converter**'; in such a fast way to have set all the parameters for the **SLAVE device 2** identical to **SLAVE device 1**,
- exit from the **SLAVE devices** menu,
- **Register number displaying** set in **hexadecimal**,

Example 7.14.5.2: Configuration of the Modbus Input in the MASTER mode.

In this example we show how to configure the **Input channel** of SLAVE device, e.g. for TRS-04a device with **address 3**. We read the **Register 1**, **Register 5** is the **Decimal point register**, **Register 2** is the **Status register** which the value of 80h means that the temperature measurement exceeds the 85°C.

In the first step we enter the **Modbus** → **SLAVE device** menu. We select by using arrows in upper navigation bar the appropriate **address** of SLAVE device (**address 3**). **Device type** parameter we set to **defined** or we can use predefined template with available settings for TRS-04a device by pressing **Load device templates** button. In this example we use first case when the SLAVE device is defined by user. Next we go to the block parameters **Device channel** and pressing the **Input list** button. In the **Input list** menu to open new input channel we press a button '+'. When we want to delete a channel press the button '-'. After adding the new input channel need to set appropriate parameters. Parameter **Value register** we set like in the Fig. 7.102. Next we exit from **Value register** menu.

HR 1h, b.0-15	
Register type:	HOLDING
Register number:	1h
Data format:	16 bits, signed
Data shift:	0
Data mask:	0xFFFF
<input type="checkbox"/> 	

Fig. 7.102. Value register parameters

In the **Decimal point** parameter we select option: value multiplied by the **Decimal point register** (***exp(-point register)**) and in the **Decimal point register** parameter we write values as for the **Value register** of Fig. 7.102 with the change to the register number 5. Next point we set block parameters for **Channel status -Hi-**. The settings of block parameters shown in the Fig. 7.103. The remaining values are left inactive (value: **never**).

The screenshot shows a configuration window for 'Channel status -HI-'. At the top, there is a navigation bar with 'Input chan.number: 1' and arrows for navigation. Below this, a 'Decimal point: * 1' field is visible. The main section is titled 'Channel status -HI-' and contains three input fields: '-HI- state: if register = value', '-HI- register: HR 2h, b.0-15', and '-HI- value: 0x00000002'. At the bottom of the window, there are three buttons: a green plus sign, a red minus sign, and a green checkmark.

Fig. 7.103. Sample setting for the block parameters: Channel status -HI-

After configuration the **Input channels** of the device we set parameters **Register blocks**. However we exit **Input list** menu and move window over parameters called **Register blocks** and set them as follow – **Block configuration mode** we set to automatic, **Max. block size** we set to 3. **MultiCon CMC-99/141** device automatically select the optimal list of blocks. After whole configuration exit the menu pressing **Save changes**.

Example 7.14.5.3: Configuration of the Modbus Output in the MASTER mode.

In this example we show how to configure the **Output channel** of SLAVE device, e.g. for TRS-10a device with **address 5**. Save data to **Register 1**, **Register 2** set to 0, **Register 5** set to 0 (mode: decimal).

In the first step we enter the **Modbus** → **SLAVE device** menu. We select by using arrows in upper navigation bar the appropriate **address** of SLAVE device (**address 5**). **Device type** parameter we set to **defined** or we can use predefined template with available settings for TRS-10a device by pressing **Load device templates** button. In this example we use first case when the SLAVE device is defined by user. Next we go to the block parameters **Device channel** and pressing the **Output list** button. In the **Output list** menu to open new output channel we press a button '+'. When we want to delete a channel press the button '-'. After adding the new output channel need to set appropriate parameters. The **Output active** parameter set to **active** - when you set **no** then the output will be defined but invisible after exit from **Modbus** menu. **Control type** parameter set to **as a linear output**. Parameter **Output register** we set like in the Fig. 7.102. Next we exit from **Output register** menu.

HR 1h, b.0-15	
Register number:	1h
Data format:	16 bits, signed
Data mask:	0xFFFF
Data shift:	0
	

Fig. 7.104. Configuration Output register parameter for Modbus protocol

Similar steps we do for other output channels to **registers 2 and 5**, then exit from **Output list** menu.

After configuration the **Output channels** of the device we set parameters **Register blocks**. However we exit from **Output list** menu and move window over parameters called **Register blocks** and set **Block configuration mode** to manual. We press button **Block list**. We select by using arrows in upper navigation bar the appropriate **block number 1**. Block type we set to write HOLDING register. The **Register size** parameter we select to **16 bit registers**. In the parameter **First register** we write: 1 and in the parameter **Last register** we write: 2 (see Fig. 7.105). Next we go to the **Register block 2** and write to the first two parameters values like in the **Register block 1** however, in the parameter **First register** we write: 5 and in the **Last register** we write: 5.

After whole configuration exit the menu pressing **Save changes**.





Block number:	 1 
Block type:	write HOLDING reg.
Register size:	16-bit registers
First register:	1h
Last register:	2h
  	

Fig. 7.105 Register blocks parameters

7.15. NETWORK SETTINGS

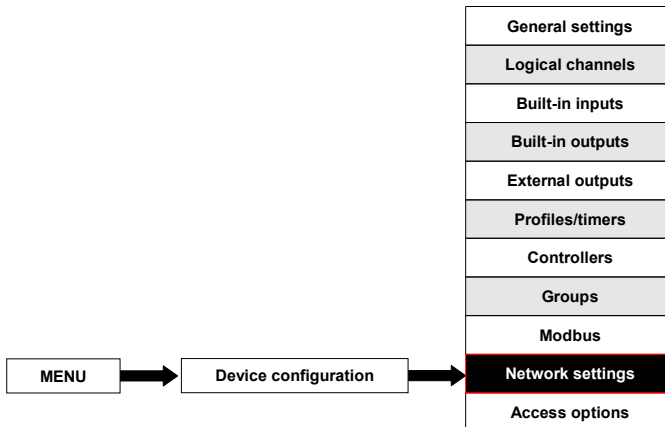

Network settings menu allows the user to configure the network settings by downloading and visualizing the data from the device through the Ethernet connection. Parameters of the **Network settings** should be:

- **DHCP** (Dynamic Host Configuration Protocol) - allows a device to be configured automatically, eliminating the need for intervention by a network administrator,
 - **disabled** - **DHCP** is disabled, the user needs to manually enter an **IP address** and **Subnet mask** in the following fields, and a **Default gateway** address if required.
 - **enabled** - the network settings are automatically generated by the DHCP server, after setting the DHCP, it takes several seconds before the IP address is obtained from the DHCP server, if user set this option other parameters in this menu are invisible,
- **IP address** - this parameter is visible only for **DHCP=disabled**, the user may enter an IP address,
- **Subnet mask** - this parameter is visible only for **DHCP=disabled**, this sets a range of IP addresses that can be accessed,
- **Default gateway** - this parameter is visible only for **DHCP=disabled**, this allows the user to enter a gateway address for use when the device is to communicate outside the local network.



For **DHCP=disabled** the parameters **IP address** and **Subnet mask** must be configured correctly, depending on the local network settings which will work with the device. User should contact with network administrator in case of errors in communication.

The actual network settings are visible in the **Device Information** menu (see **Chapter 7.4. DEVICE INFORMATION, LICENSE AND FIRMWARE UPDATE**).

7.16. ACCESS OPTIONS

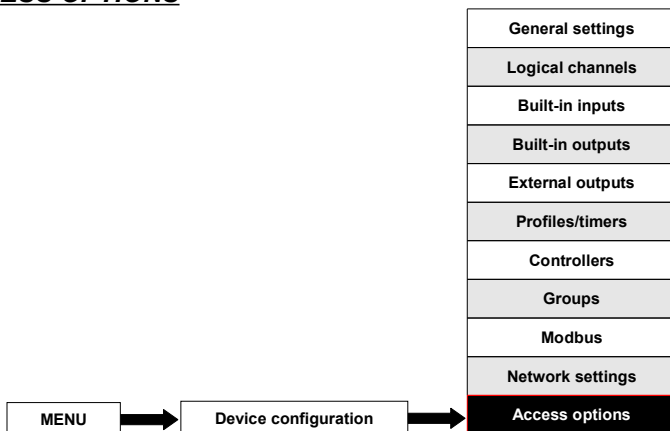

To prevent accidental or unauthorized change the settings in the **Device configuration** menu and **File management**, the user can set in the **Access options** menu the access password. If the user has enabled the access options then before going to the next menu level will be asked for password as in Fig. 7.28.

If user want to activate the access password they need to press the button next to **Access password** label and enter any password. In place of the text will be displayed asterisk '*'. After accepting this password in place of the entered password will be 8 asterisks regardless of password length.

If user wants to inactivate the access password then the user needs to press the button next to **Access password** label and delete password. After accepting this the text editor will place an empty field in place of the **Access password** label.

8. APPENDIX - INPUT AND OUTPUT MODULES DESCRIPTION



All connections must be made while power supply is disconnected !

8.1. PS3, PS4 - POWER SUPPLY MODULE

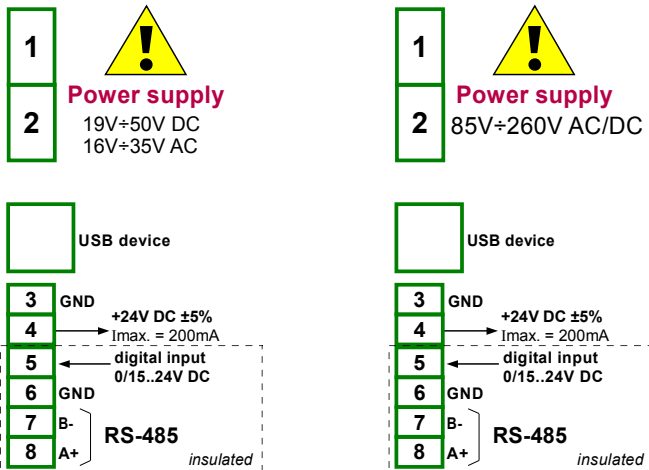

Fig. 8.1 Available power supply module: PS3 (left side) and PS4



In case of **UN3** module installed , there is **no +24V DC output** and this terminal stay not connected. This limitation is temporary and will be removed soon.

Most important parameters of PS modules.

	PS3	PS4
Number of inputs/outputs	5	5
Power supply	19V...24...50V DC 16V...24...35V AC	85V...230...260 AC/DC 50 60Hz
USB device	Service port	
Sensor power supply output	24V DC ±5% / max. 200mA	
Permissible Long time overload	20%	20%
Digital input	0...15...24V DC with galvanic insulated power consumption: 7,5 mA / 24V, insulation: 1min @ 500V DC.	
Interface	RS-485, Modbus RTU, 1200bit/sec. ÷ 115200 bit/sec.	
weight	65g	

8.2. UI4, UI8, U16, I16, FI4 - VOLTAGE, CURENT AND FLOW MEASUREMENT**MODULES**

The **UI** and **FI** modules are designed for easy measurement of Voltage, Current and Flow. There are 5 versions of such modules, listed below:

UI4 - 4 Voltage and 4 Current inputs,

UI8 - 8 Voltage and 8 Current inputs,

U16 - 16 Voltage inputs,

I16 - 16 Current inputs

FI4 - 4 Flowmeters inputs and 4 Current inputs.

The Fig. 8.2 shows terminals placement of UI and FI modules. Inputs are gathered into groups to make connections easier. All ground terminals of a particular module are common, but separated from power supply and other modules. If it is necessary to measure Voltages with different ground potentials, several UI modules have to be installed into **MultiCon CMC-99/141** unit.

Most important parameters of UI modules.

	UI4	UI8	U16	I16	FI4
Number of inputs	4xU + 4xI	8xU + 8xI	16xU	16xI	4xF + 4xI
Hardware measurement ranges					
voltage inputs	-2V ÷ 13V	-2V ÷ 13V	-2V ÷ 13V	-	-
current inputs	-2mA ÷ 30mA	-2mA ÷ 30mA	-	-2mA ÷ 30mA	-2mA ÷ 30mA
Hardware resolution					
voltage inputs	1mV	1mV	1mV	-	-
current inputs	1µA	1µA	-	1µA	1µA
Precision					
voltage inputs	0.25%	0.25%	0.25%	-	-
current inputs	0.25%	0.25%	-	0.25%	0.25%
Permissible Long time overload	20%	20%	20%	20%	20%
Covered MultiCon CMC-99/141 measurement ranges *	0+5V, 1+5V, 0+10V, 2+10V, 0+20mA, 4+20mA	0+5V, 1+5V, 0+10V, 2+10V, 0+20mA, 4+20mA	0+5V, 1+5V, 0+10V, 2+10V	0+20mA, 4+20mA	0+20mA, 4+20mA
Internal impedance					
voltage inputs	100kΩ	100kΩ	100kΩ	-	-
current inputs	type 100Ω	type 100Ω	-	type 100Ω	typ. 100Ω
Protection					
voltage inputs	no	no	no	-	-
current inputs	50mA auto-reset fuse	50mA auto-reset fuse	-	50mA auto-reset fuse	50mA auto-reset fuse
weight	32g	32g	42g	42g	33g

* Measurement ranges are limited by software upon hardware inputs ability, check current list of **MultiCon CMC-99/141** measurement ranges at www.simex.com.pl

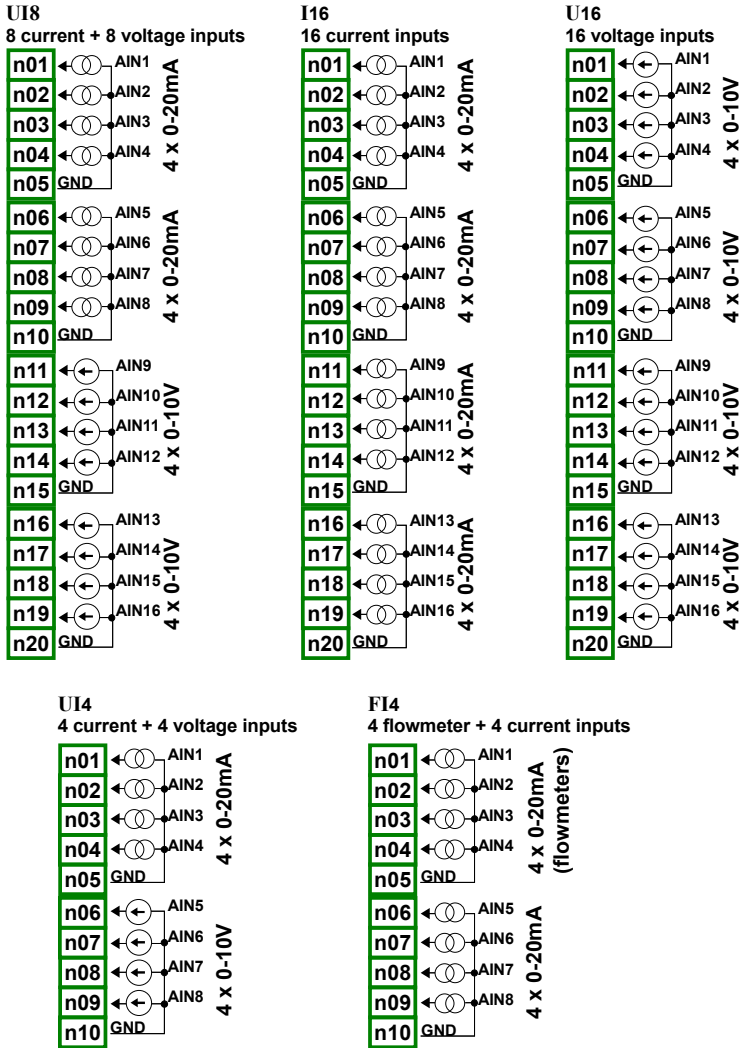

Fig. 8.2. Available current, voltage and flow measurement modules

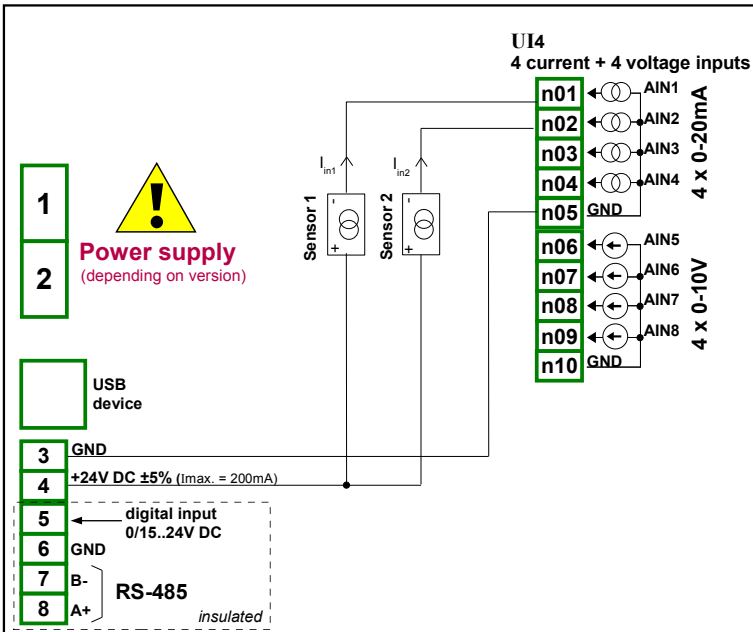

Fig. 8.3. Connections for 2 - wire sensor (current)

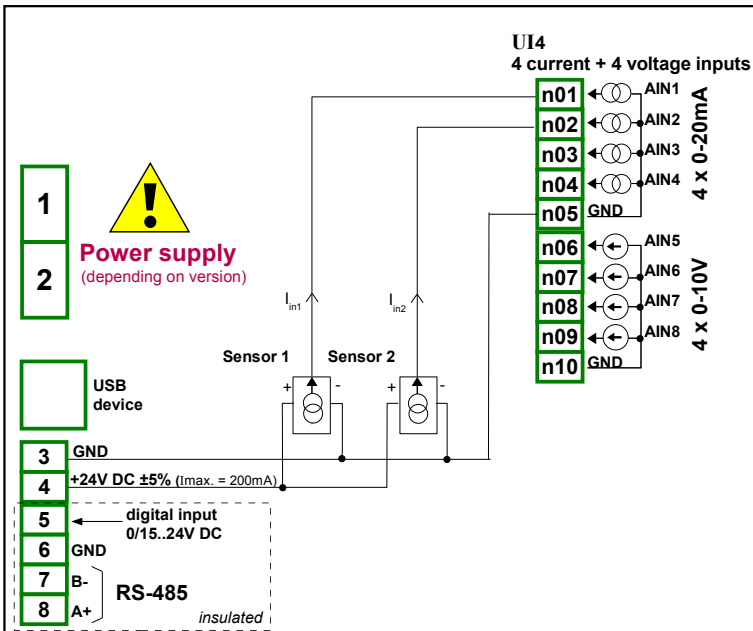

Fig. 8.4. Connections for 3 - wire sensor (current)

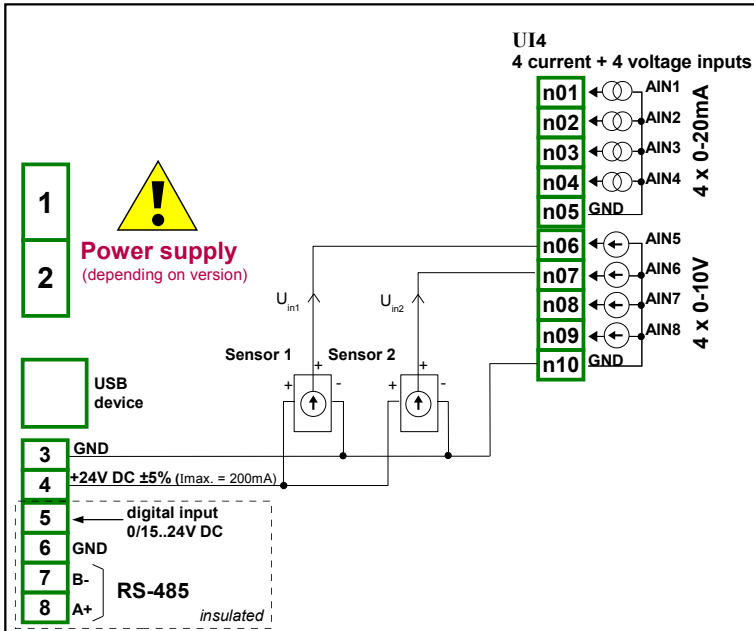
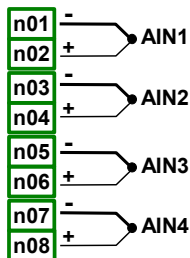

Fig. 8.5. Connections for 3 - wire sensor (voltage)

8.3. TC4, TC8 – THERMOCOUPLE SENSOR MEASUREMENT MODULES

TC4
4 thermocouple inputs



TC8
8 thermocouple inputs

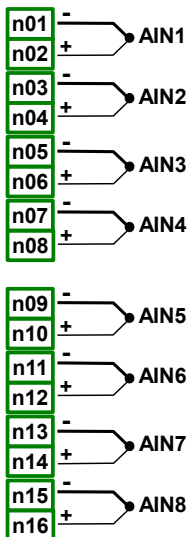

	TC4	TC8
Number of inputs	4	8
Hardware measurement ranges	-30mV ÷ 30mV -120mV ÷ 120mV	-30mV ÷ 30mV -120mV ÷ 120mV
Hardware resolution	range ± 30mV 1µV range ± 120mV 4µV	1µV 4µV
Permissible Long time overload	20%	20%
Permissible voltage difference between channels **	0.5V	0.5V
Covered MultiCon CMC-99/141 measurement ranges * Thermocouple: Voltage:	K, S, J, T, N, R, B, E, L(GOST) ±25mV, ±100mV	K, S, J, T, N, R, B, E, L(GOST) ±25mV, ±100mV
Input impedance	typ. 1MΩ	typ. 1MΩ
Weight	32g	42g

* Measurement ranges are limited by software upon hardware inputs ability, check current list of **MultiCon CMC-99/141** measurement ranges at www.simex.com.pl

** Hi and Lo terminals of all inputs are pulled up/down by 470kW resistor to internal supply/GND. It is strongly recommended not to connect Lo or Hi terminals of different inputs

together, but to connect every sensor using individual wires.

type	range	resolution	full range	full range accuracy		limited range	limited range accuracy	
	[mV]	[μ V]	[°C]	[°C]	[%]	[°C]	[°C]	[%]
K	± 120	4	-200+1370	± 8	± 0.51	-100+1370	± 4	± 0.27
S	± 30	1	-50+1768	± 7.5	± 0.41	0+1768	± 6	± 0.34
J	± 120	4	-210+1200	± 6.3	± 0.44	-100+1200	± 3	± 0.23
T	± 30	1	-200+400	± 1.9	± 0.31	-100+400	± 1	± 0.20
N	± 120	4	-200+1300	± 12	± 0.80	-100+1300	± 5.9	± 0.42
R	± 30	1	-50+1768	± 8.6	± 0.47	0+1768	± 5.5	± 0.31
E	± 120	4	-200+1000	± 4.7	± 0.40	-100+1000	± 2.7	± 0.25
L	± 120	4	-200+800	± 4.4	± 0.44	-100+800	± 2.5	± 0.28

type	norm
K	PN-EN 60584-1:1997
S	PN-EN 60584-1:1997
J	PN-EN 60584-1:1997
T	PN-EN 60584-1:1997
N	PN-EN 60584-1:1997
R	PN-EN 60584-1:1997
E	PN-EN 60584-1:1997
L	GOST R 8.585:2001

8.4. RT4 – RTD MEASUREMENT MODULE

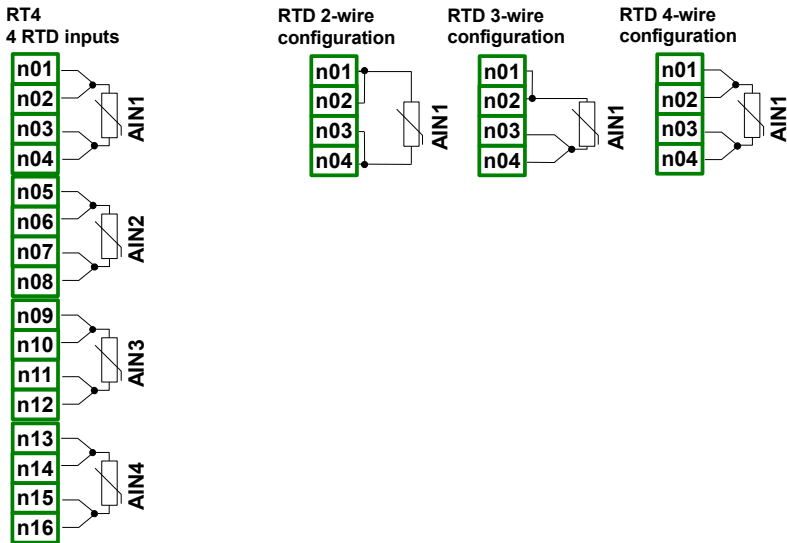

	RT4
Number of inputs	4
Hardware measurement ranges	0÷325Ω, 0÷3250Ω
Hardware resolution	range ±325Ω 0.01Ω range ±3250Ω 0.1Ω
Covered MultiCon CMC-99/141 measurement ranges *	PT100, PT500, PT1000, Cu50, Cu100, RTD: Cu'50, Cu'100
Connection method	2, 3 and 4 wire (switched manually)
Weight	42g

Measurement ranges are limited by software upon hardware inputs ability, check current list of **MultiCon CMC-99/141** measurement ranges at www.simex.com.pl

Hardware accuracy 0.1% @ 25°C

type	range [Ω]	temperature range [$^{\circ}\text{C}$]	resolution [Ω]	accuracy [$^{\circ}\text{C}$]	accuracy [%]
Pt100	0÷325	-100÷600	0.01	± 1	± 0.14
Pt500	0÷3250	-100÷600	0.1	± 2	± 0.3
Pt1000	0÷3250	-100÷600	0.1	± 1	± 0.14
Pt'50	0÷325	-200÷600	0.01	± 2	± 0.25
Pt'100	0÷325	-200÷600	0.01	± 1	± 0.12
Pt'500	0÷3250	-200÷600	0,1	± 2	± 0.25
Cu50	0÷325	-50÷200	0.01	± 1.8	± 0.73
Cu100	0÷325	-50÷200	0.01	± 0.9	± 0.37
Cu'50	0÷325	-200÷200	0.01	± 1.6	± 0.4
Cu'100	0÷325	-200÷200	0.01	± 0.8	± 0.2
Ni100	0÷325	-60÷180	0.01	± 0.7	± 0.3
Ni500	0÷3250	-60÷180	0.1	± 1.4	± 0.58
Ni1000	0÷3250	-60÷180	0.1	± 0.7	± 0.3

type	norm
Pt100	PN-EN 60751:2009
Pt500	PN-EN 60751:2009
Pt1000	PN-EN 60751:2009
Pt'50	GOST 6651-94 ($W_{100}=1,3910$)
Pt'100	GOST 6651-94 ($W_{100}=1,3910$)
Pt'500	GOST 6651-94 ($W_{100}=1,3910$)
Cu50	PN-83M-53852 ($W_{100}=1,4260$)
Cu100	PN-83M-53852 ($W_{100}=1,4260$)
Cu'50	PN-83M-53852 ($W_{100}=1,4280$)
Cu'100	PN-83M-53852 ($W_{100}=1,4280$)
Ni100	PN-EN 60751:2009
Ni500	PN-EN 60751:2009
Ni1000	PN-EN 60751:2009

8.5. UN3 – OPTOISOLATED UNIVERSAL INPUT MODULE

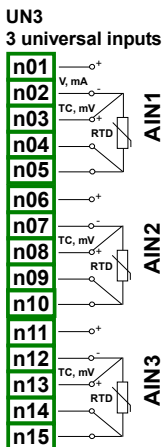

Fig. 8.6. Available universal input module

UN3 is a module with 3 universal inputs allows to:

- current measurements,
- voltage measurements,
- temperature measurements (TC or RTD).

Most important parameters of **UN3** modules:

	UN3
Number of inputs	3
Hardware measurement ranges	current inputs: -2mA ÷ 30mA voltage inputs: -1V ÷ 12V thermocouple inputs: -10mV ÷ 30mV -10mV ÷ 120mV RTD inputs: 0 ÷ 325Ω, 0 ÷ 3250Ω,

Hardware resolution:	
current inputs:	1 μ A
voltage inputs:	1mV
thermocouple inputs:	
range -10mV \div 30mV	2 μ V
range -10mV \div 120mV	4 μ V
RTD inputs:	
range 0 \div 325 Ω	0,01 Ω
range 0 \div 3250 Ω	0,2 Ω
Permissible Long time overload	20%
Covered MultiCon CMC-99/141 measurement ranges *	
current inputs:	0 \div 20mA, 4 \div 20mA, 0 \div 5V,
voltage inputs:	1 \div 5V, 0 \div 10V, 2 \div 10V
thermocouple inputs:	K,S,J,T, N, R, B, E, L(GOST)
RTD inputs:	Pt100, Pt'100, Pt'50, Pt500, Pt'500, Pt1000, Cu50, Cu'50, Cu100, Cu'100, Ni100, Ni500, Ni1000
Connection method in RTD mode	2, 3 and 4 wire (switched manually)
Input impedance	
current inputs:	<65 Ω (typ. 30 Ω)
voltage inputs:	>100k Ω (while maintaining correct polarization)
thermocouple inputs:	>1,5M Ω
Weight	44g

8.6. D8, D16 – OPTOISOLATED DIGITAL INPUT MODULE

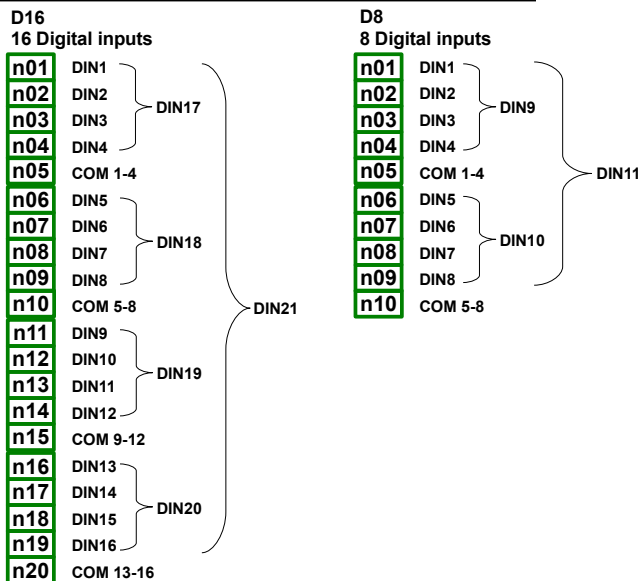

D8, D16 are modules with 8 and 16 digital inputs respectively. Inputs are divided into groups of four input every. Every group has own common terminal, and is optoisolated from others groups and **MultiCon CMC-99/141** GND signal as well.

	D8	D16
Number of inputs	8 (2 groups 4 inputs every, optoisolated from others signals)	16 (4 groups 4 inputs every, optoisolated from others signals)
Input signals voltage levels:		
Logical LOW state	Uin < 1V	Uin < 1V
Logical HIGH state	Uin > 4V	Uin > 4V
Max input voltage	30V	30V
Input current consumption	about 15mA @24V about 5mA @10V about 2mA @5V	about 15mA @24V about 5mA @10V about 2mA @5V
Insulation strength	500V	500V
Input signals representation	8 single bits DIN1-DIN8 2 nibbles DIN9-DIN10 1 byte DIN11	16 single bits DIN1-DIN16 4 nibbles DIN17-DIN20 1 integer DIN21
Weight	40g	30g

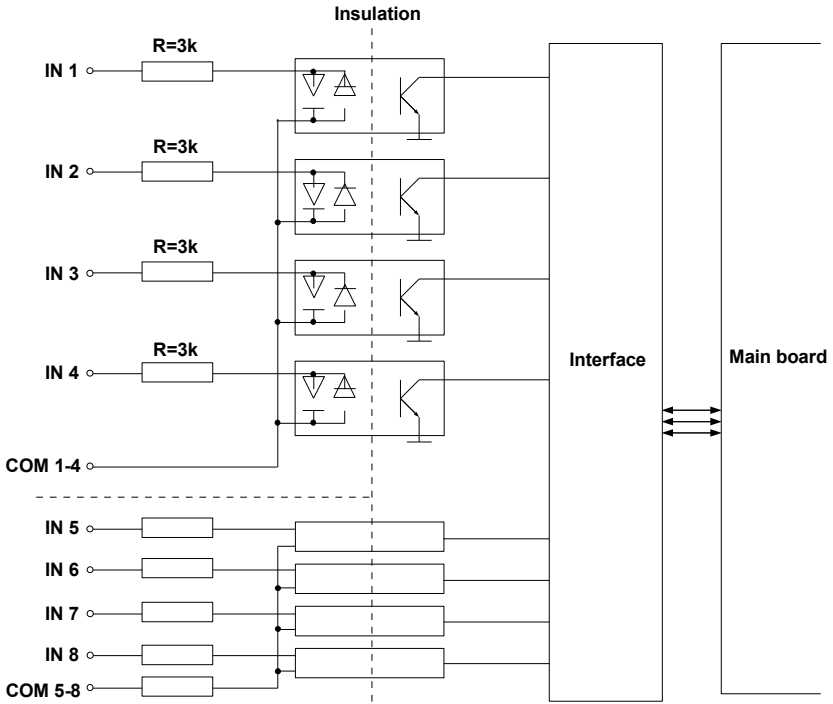

Fig. 8.7. Internal structure of the optoisolated digital input module

8.7. CP4 – OPTOISOLATED UNIVERSAL COUNTER MODULES

Inp[n]1, Inp[n]2 - counting inputs, pulse

Prg[n] - programmable inputs,

Res[n] - reset inputs,

COM[n] - common inputs,

[n]=1, 2, 3, 4.

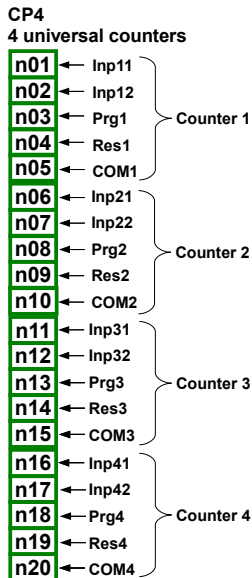

Fig. 8.8. Available optoisolated module of universal counters

CP4 is module of universal 4-input counters (Fig. 8.8). Each counter has common terminal (**COM**) and is optically isolated from other counters and and **MultiCon CMC-99/141** GND signal as well.

Most important parameters of **CP4** modules:

	CP4
Number of inputs	4 groups of counter inputs (4 groups 4 inputs every, optoisolated from other signals)
Terminal description	Inp[n]1, Inp[n]2 - counting inputs, pulse, Prg[n] - programmable inputs, Res[n] - reset inputs, COM[n] - common inputs, [n]=1, 2, 3, 4.
Input signals voltage levels:	
Logical LOW state:	U _{in} < 1V
Logical HIGH state:	U _{in} ≥ 10V
Max input frequency	5kHz
Max input voltage	30V

Input current consumption	about 14mA @24V about 6mA @10V
Insulation strange	2kV
Protection	50mA auto-reset fuse
Weight	42g

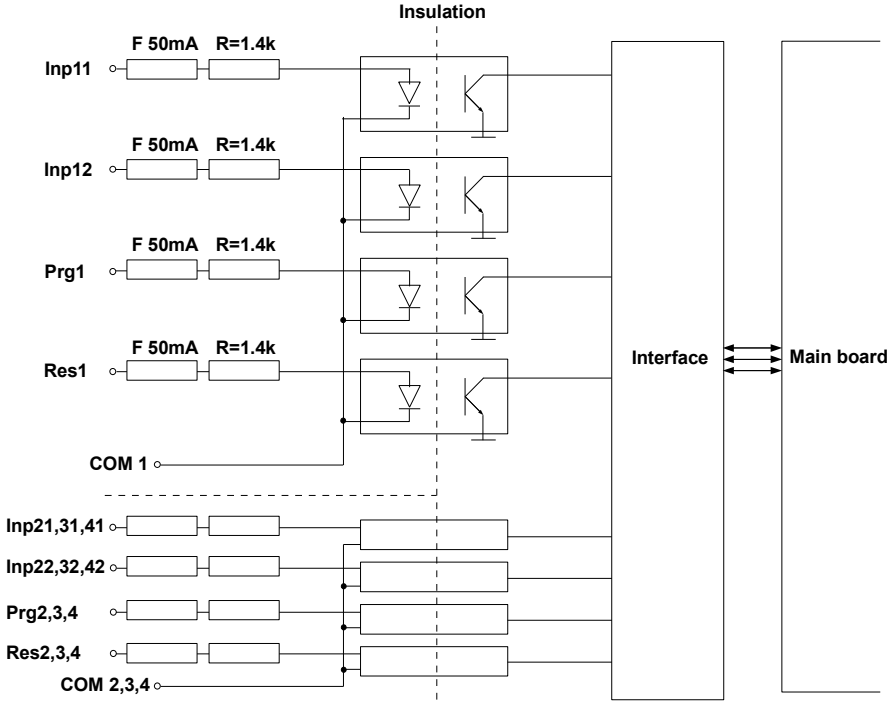
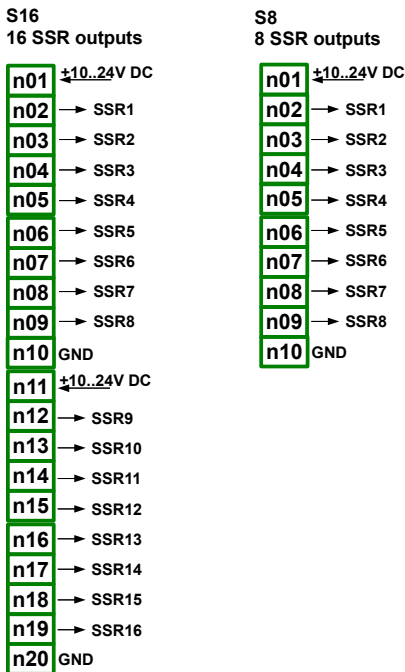

Fig. 8.9. Internal structure of the optoisolated universal counter module

8.8. S8, S16 - SOLID STATE RELAY DRIVERS MODULES



	S8	S16
Static parameters		
Number of outputs	8	16 (in 2 groups with separate supply)
Max current source per output:		
while powered internally	10mA, sum limited to 50mA	10mA, sum limited to 50mA for a group
while powered externally	100mA, sum limited to 500mA	100mA, sum limited to 500mA for a group
Output High Level voltage (Iout =5mA)		
while powered internally	≥ 8V	≥ 8V
while powered externally	≥ (Vext. - 0.5V)	≥ (Vext. - 0.5V)
Overload protection		
while powered internally	Internal fuse 50mA	Internal fuse 50mA (per group)
while powered externally	Internal fuse 500mA	Internal fuse 500mA (per group)
Maximum external supply of output *	30 V	30 V

Dynamic parameters (set individually for every output)		
PWM period **	0.1 ÷ 1600 sec.	0.1 ÷ 1600 sec.
PWM resolution	0.1 sec.	0.1 sec.
PWM internal frequency**	5kHz***	5kHz***
Pulse - duty factor	0 ÷ 100%	0 ÷ 100%
Pulse - duty factor resolution	15 bits ** 0x8000 means 100%	15 bits** 0x8000 means 100%
Lo state minimum time limit	0 ÷ 800 sec.	0 ÷ 800 sec.
Hi state minimum time limit	0 ÷ 800 sec.	0 ÷ 800 sec.
Weight	32g	42g

* Minimum external supply voltage is 10V, if external supply is less than 10V then outputs are powered internally

** PWM internal frequency and PWM period limit Pulse - duty factor real resolution. For example, if PWM period is 0.1 sec then real resolution of Pulse - duty factor is about 9 bits ($0.1 * 5\text{kHz} = 500$ levels). If PWM period is longer than 6.55 seconds then Pulse - duty factor resolution is full 15 bits ($6.56 * 5\text{kHz} > 32768$ levels).

*** PWM output quantization: 20µs

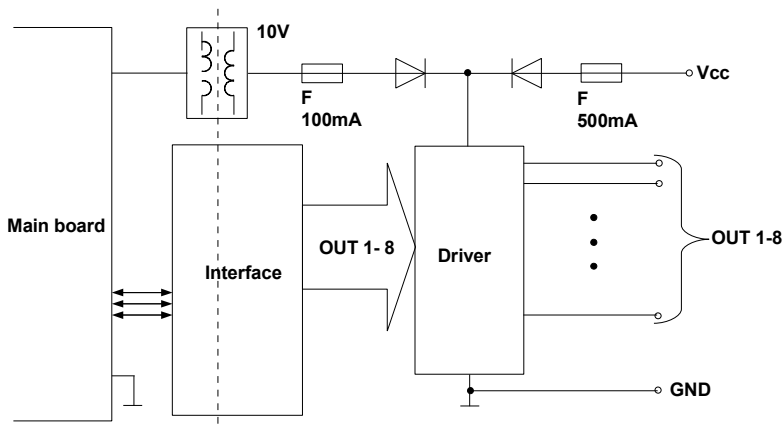

Fig. 8.10. Internal structure of the SSR output module (8 output)

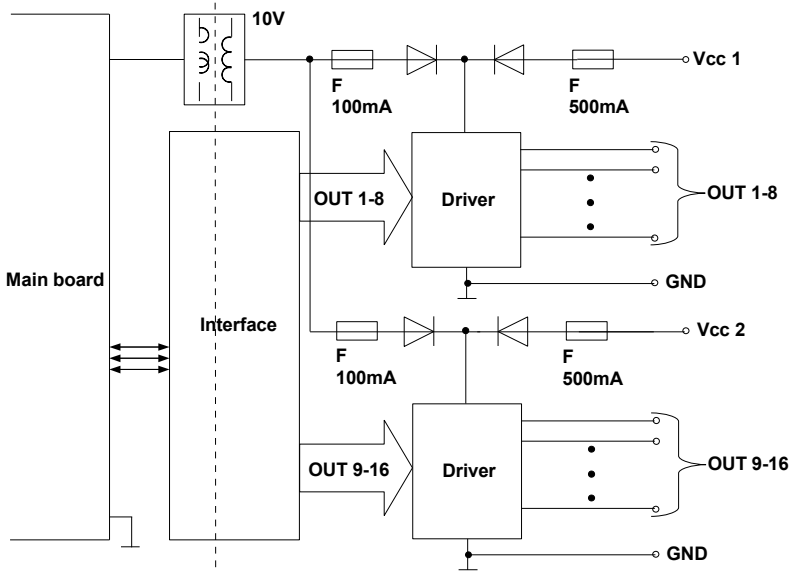
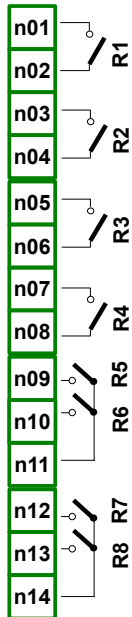

Fig. 8.11. Internal structure of the SSR output module (16 output)

8.9. R45, R81 - RELAY MODULES

R81
8 relay outputs 1A/250V



R45
4 relay outputs 5A/250V

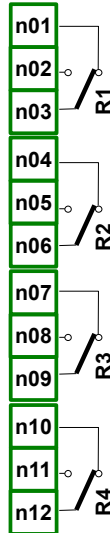

	R45	R81
Number of relays	4 SPDP (Switchable)	8 SPST (N.O.)
Max. load per relay	5A, $\cos \varphi = 1$ (resistive load)	1A, $\cos \varphi = 1$ (resistive load)
Max. voltage switched by relay	250V AC	250V AC
Insulation strength (relay to relay, relay to MultiCon CMC-99/141 supply)	$\geq 1000V$ AC @ 60 sec.	$\geq 1000V$ AC @ 60 sec.
Weight	50g	74g

8.10. IO2, IO4 – PASSIVE CURRENT OUTPUT

IO4
4 current output

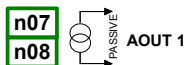
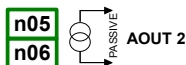
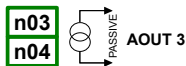
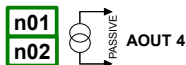

IO2
2 current output

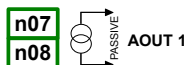
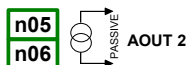

As the output is passive type, it is required to power the current loop. Note that polarisation of IO2 and IO4 outputs does not matter.

Technical specification:

	IO2	IO4
Number of outputs	2	4
Output type	Passive current output	Passive current output
Nominal analogue range	4-20mA	4-20mA
Hardware output limitation	3-22mA	3-22mA
Output voltage dropout	max. 9V	max. 9V
Overload protection	Internal resettable fuse 50mA	Internal resettable fuse 50mA
Loop Supply Range	9-30V	9-30V
Output current precision	0.1% @25°C, 50ppm/°C	0.1% @25°C, 50ppm/°C
Resolution	12 bit	12 bit
Weight	23g	30g

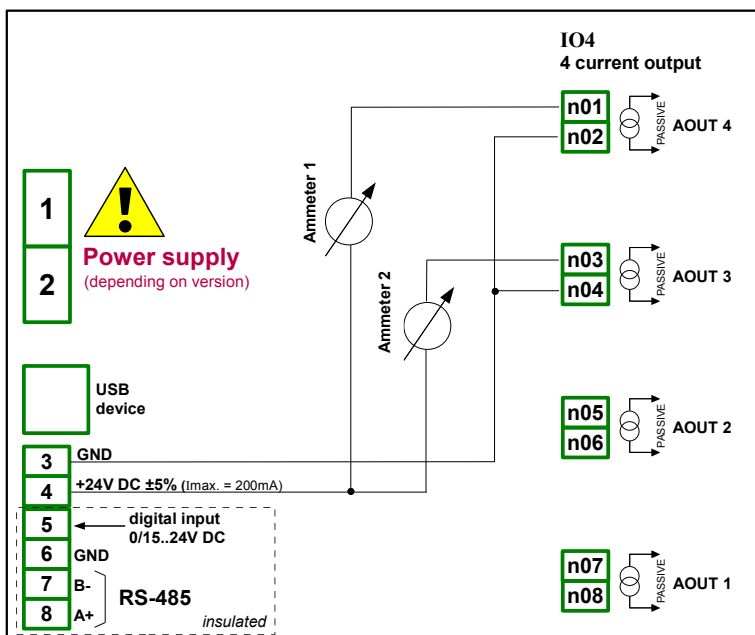

Fig. 8.12. Connections for the Passive current output from GND side

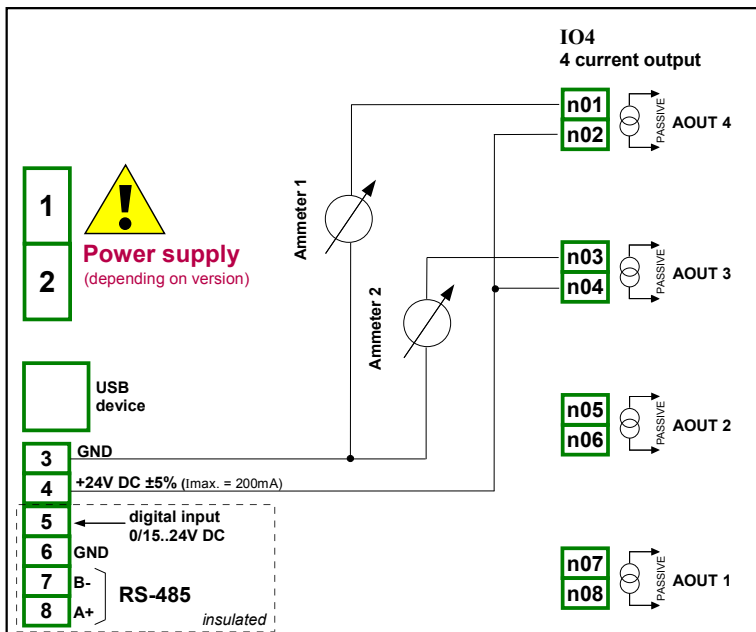

Fig. 8.13. Connections for the Passive current output from Power supply side

8.11. COMMUNICATION MODULES

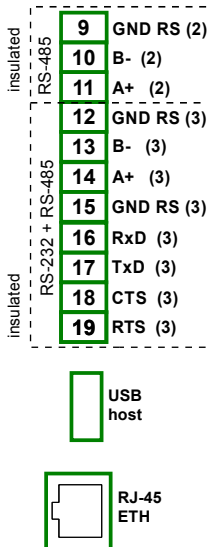

Fig. 8.14. Available communication modules: ACM and USB (back - USB host only)

	USB (back)	ACM
Number of inputs/outputs	1	4
Input/output type	USB host	RS-485, RS-232+RS-485, USB host, RJ-45 ETH
Hardware output limitation	USB host: max current output 100mA	USB host: max current output 100mA
Baudrate	USB host 12Mb/sec.	RS-485 [bit./sec.]: 1200, 2400, 4800, 9600, 19200, 38400, 57600, 115200, RJ-45 ETH:10Mb/sec. USB host 12Mb/sec.
Data format		RS-232/485: 8N1, 8N2, 8E1, 8E2, 8O1, 8O2
Weight	21g	48g



SIMEX Sp. z o.o.
ul. Wielopole 7
80-556 Gdańsk
Poland

tel.: (+48 58) 762-07-77
fax: (+48 58) 762-07-70

<http://www.simex.pl>
e-mail: info@simex.pl